

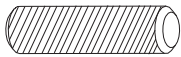

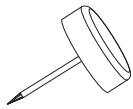

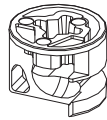

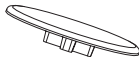



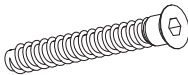
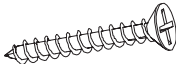
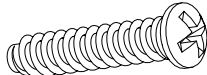
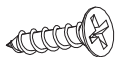
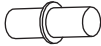

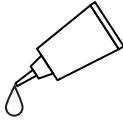
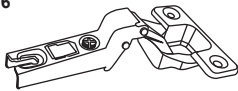

K1 x 23 	SG1 x 7 	B2 x 18 
ZM1 x 12 	ZS1 x 8 	ZJ1 x 18 
KT1 x 10 6,3x50 	WT22 x 4 4x35 	WE1 x 12 6,3x30BM 
WT1 x 24 3,5x15 	PO2 x 12 	GW1 x 100 
KL x 1 	ZP7 x 6 	UBO x 4 
PK1 x 6 H-0 	D7 x 2 L-778 	UIQ x 2 
PO4 x 2 	DS4 x 6 H-18 	x 1 
PO7 x 2 Ø5 	LT x 2 	WT9 x 19 3 x 16 

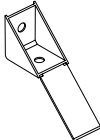
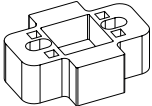

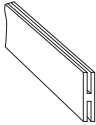
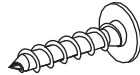
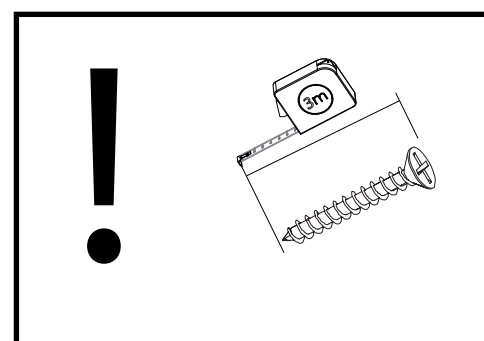
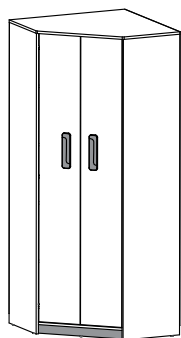

	CODE			
1	IQ01KHDF_02	407	1918	2
2	IQ01K_07	297	286	1
3	IQ01K_12	280	1882	2
4	IQ01K_08	296	28	3
5	IQ01K_03	1964	401	1
6	IQ01K_05	1888	396	1
7	IQ01K_04	1964	401	1
8	IQ01K_10	250	60	1
9	IQ01K_11	250	60	1
10	IQ01W_01	607	60	1
11	IQ01K_06	1888	300	1
12	IQ01K_02	802,50	802,50	1
13	IQ01K_01	820	820	1
14	IQ01K_09	785	124	1
15	IQ01KHDF_01	210	1918	2

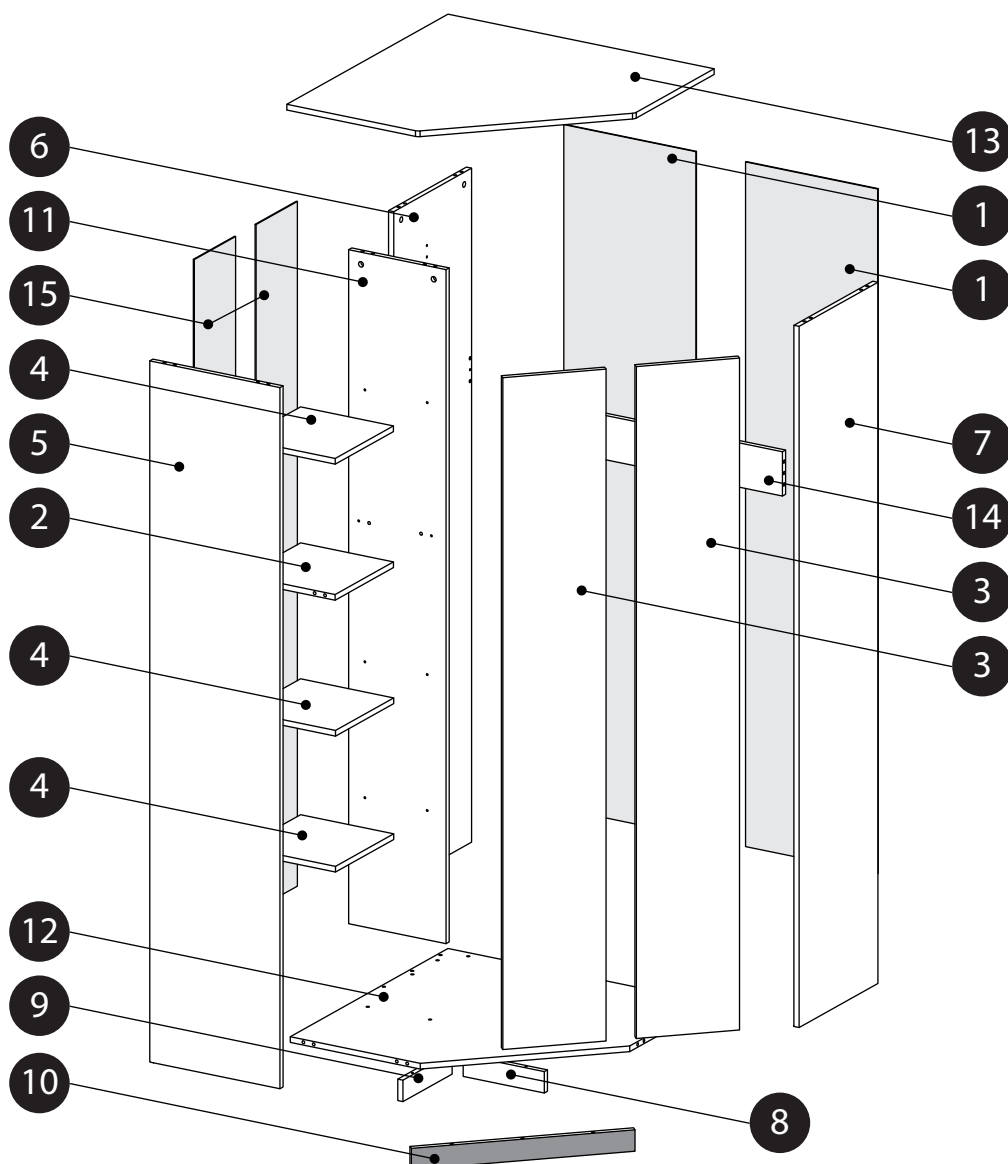

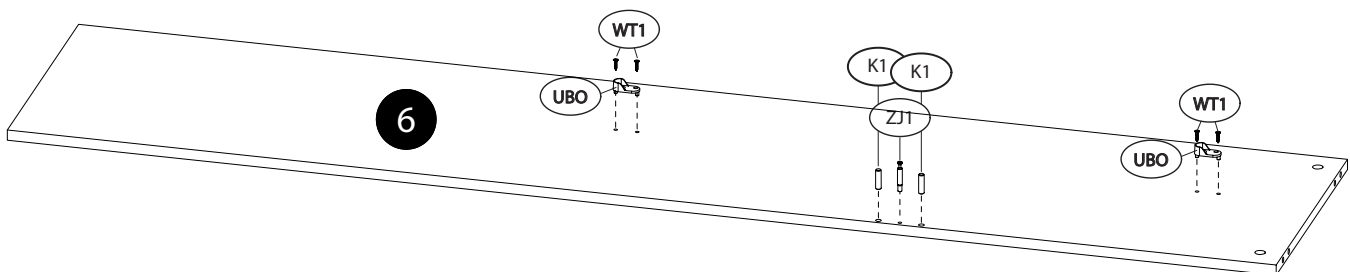
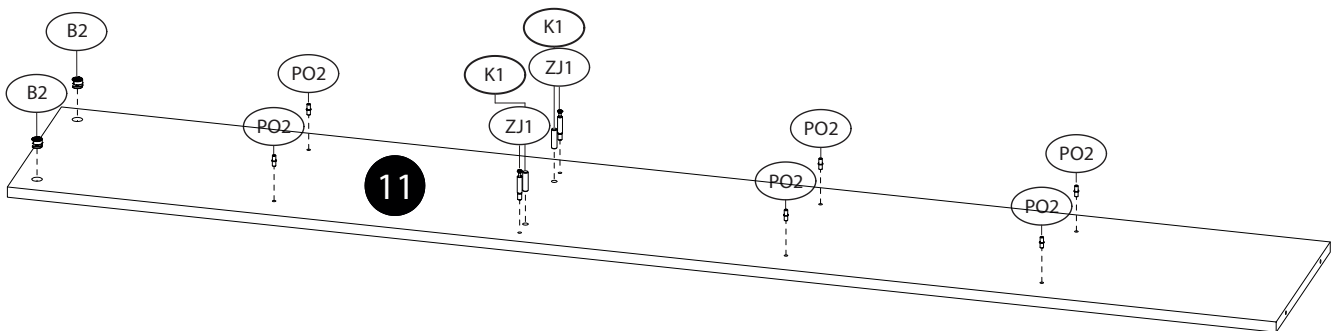
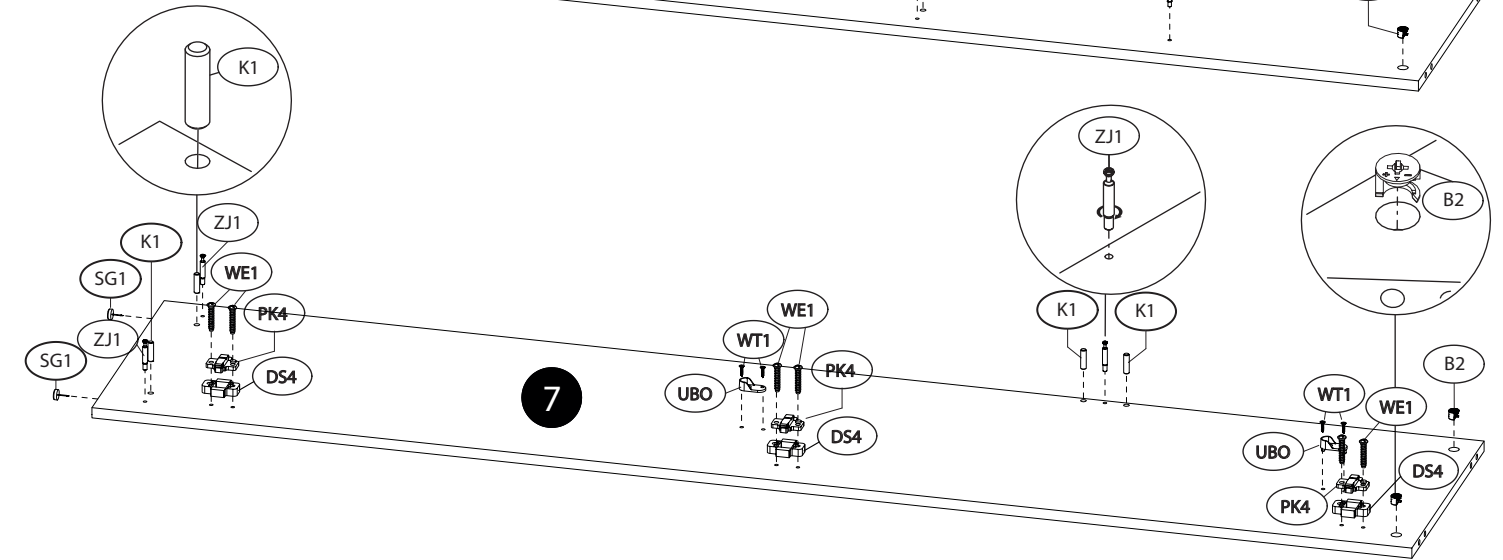
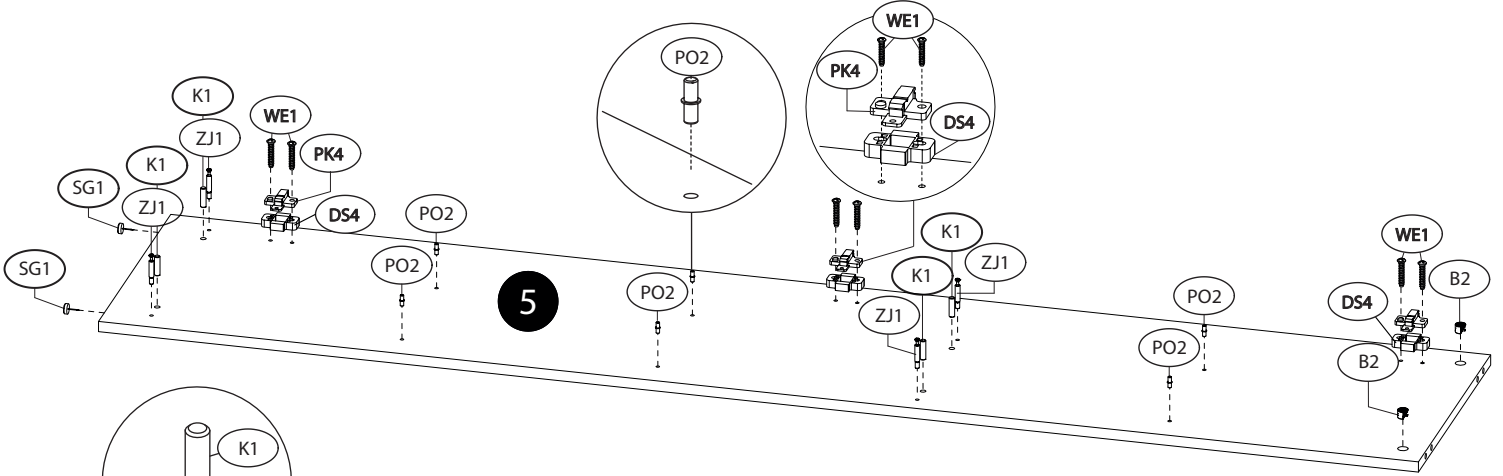
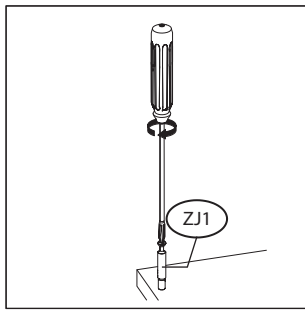
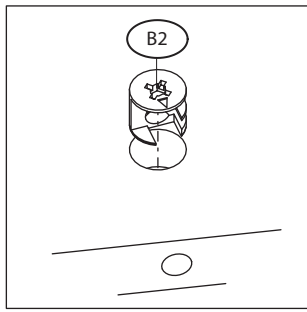
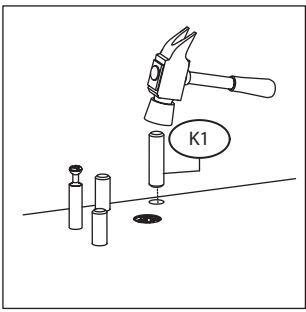

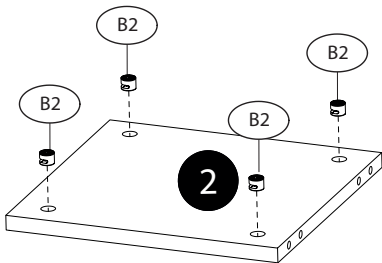
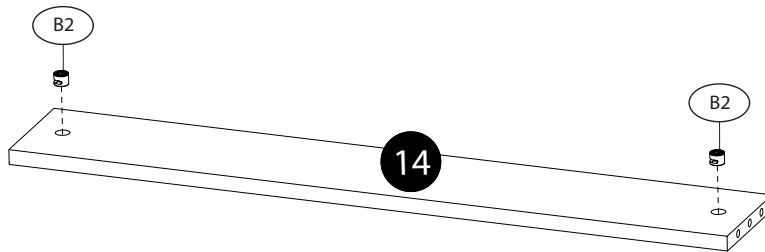
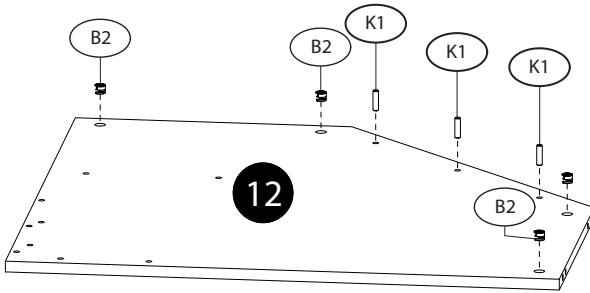
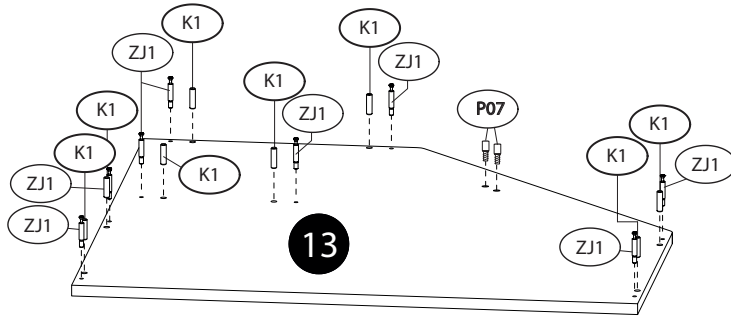

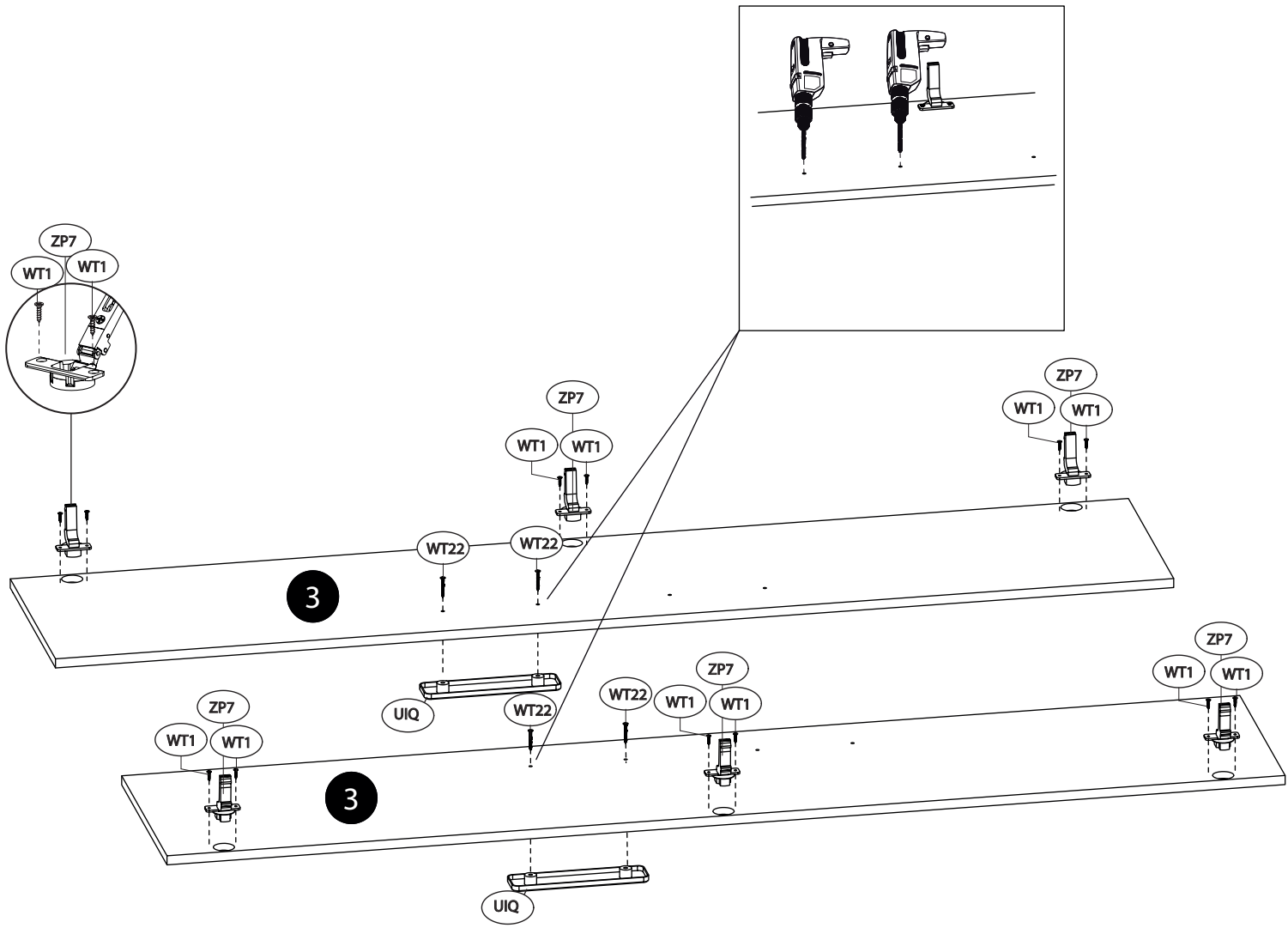

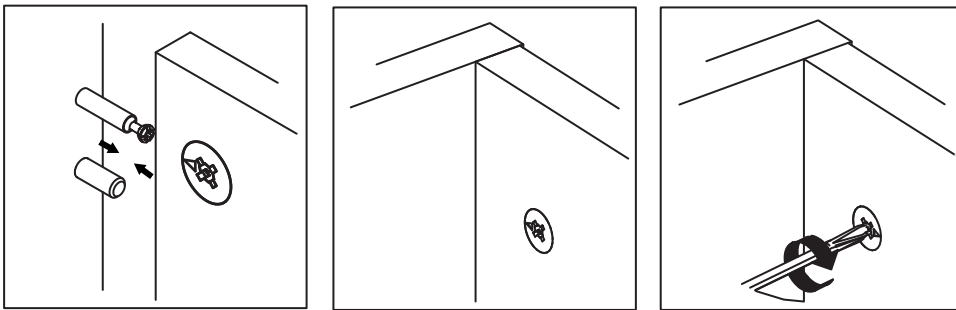

A ▶

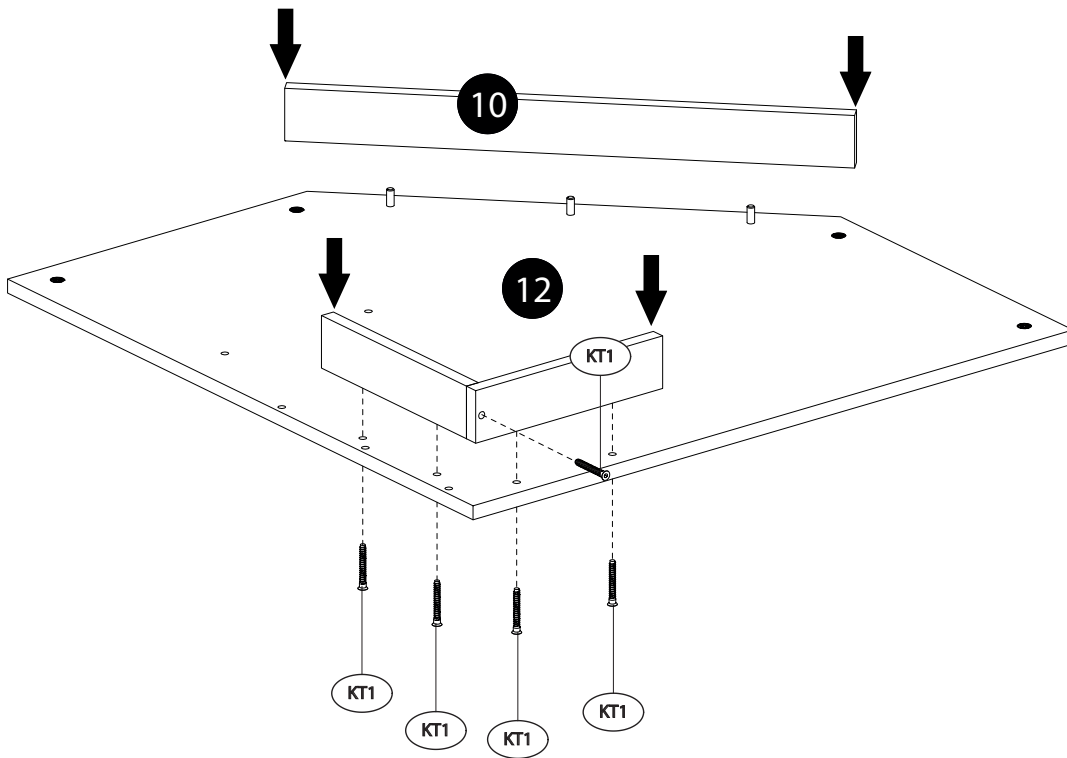

B ▶

