



www.MLMEBLE.pl

GB D CZ SK ROS LT
assembly instructions / montageanleitung / montážní návod / montážny návod / инструкции по монтажу / surinkimo instrukcija



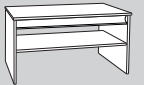

INSTRUKCJA MONTAŻU



FJORD 09

↑48 →114 ↘61

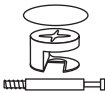
akcesoria / accessories / zubehör / příslušenství / prislušenstvo / аксессуары / furnitūra :

| | | | |
|--|--|--|---|
| x 20  KK 8/32 | x 10  MD | x 4  SG 8/8 | x 1  klej / glue / kleber / lepidlo / lepidlo / клей / klijai |
|--|--|--|---|

do montażu potrzebne są:
are needed for assembly:
sind erforderlich für die montage:
jsou potřebné pro montáž:
sú potrebné pre montáž:
которые необходимы для сборки:
Surinkimui reikės

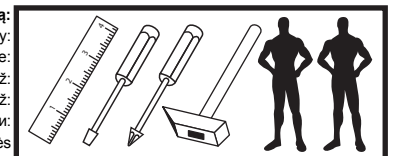

| Nr/No | Szt/Qty |
|-------|---------|
| 1 | 1 |
| 2 | 2 |
| 3 | 2 |
| 4 | 1 |
| 5 | 1 |

sequence assembly / reihenfolge montage / sekvence montáž / postupnosť montáže / последовательность ассамблеи / surinkimo eiliškumas

Kolejność montażu: I II III IV V

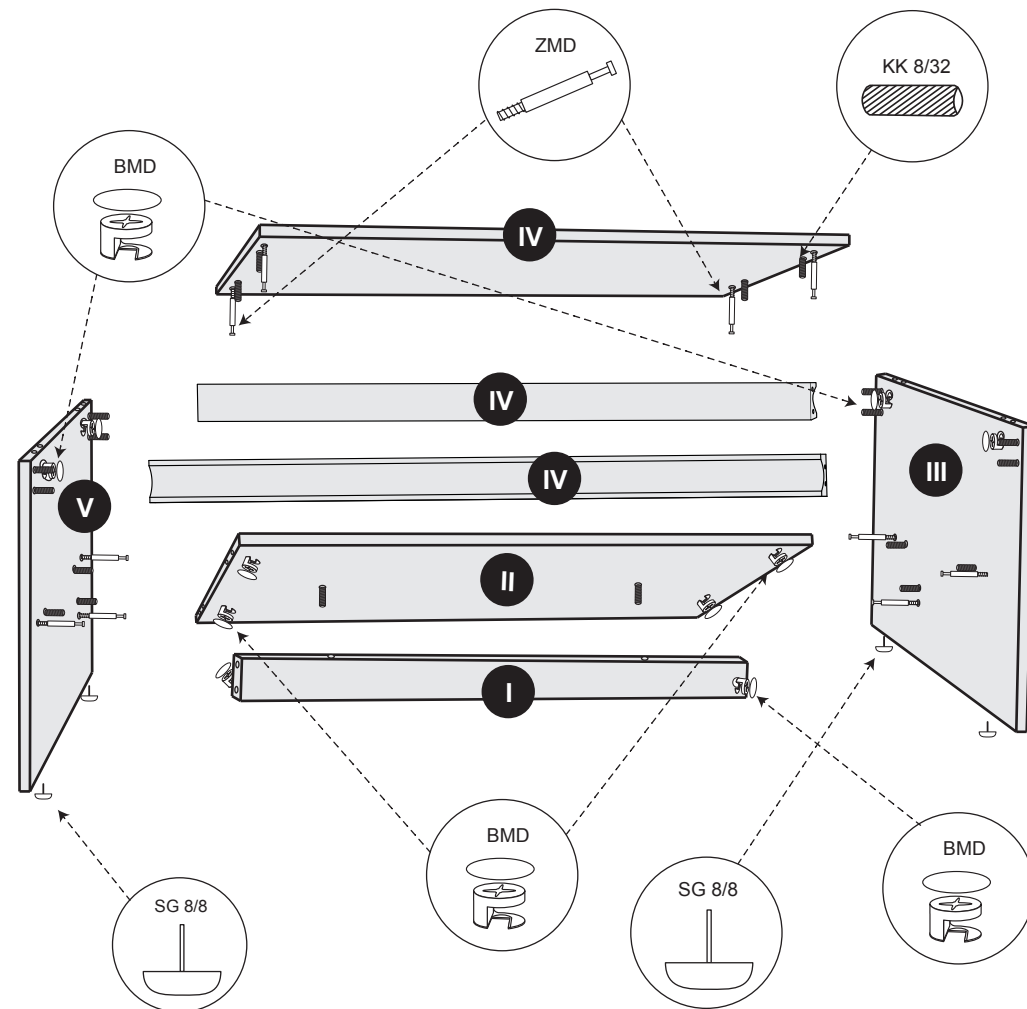
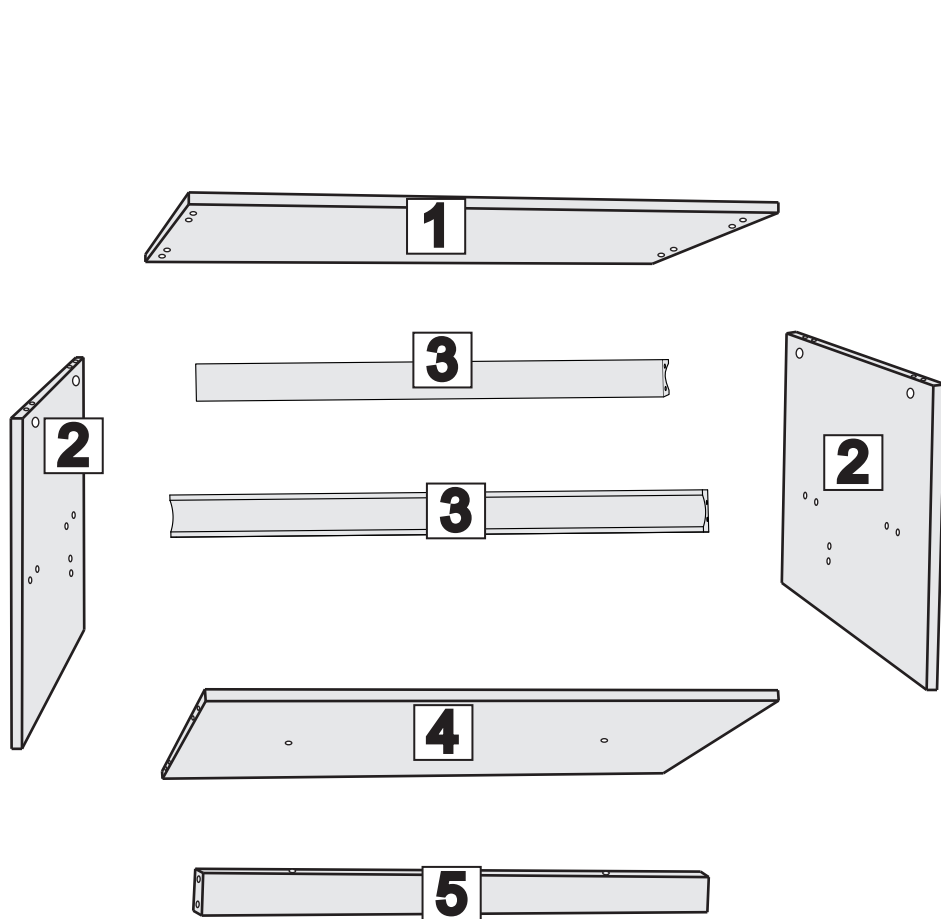
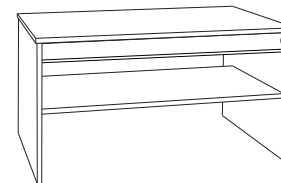

! UWAGA ! - w pierwszej kolejności wbijamy akcesoria „KK” i „MD” w blaty oraz boki.
WARNING! - The first accessory sticks "KK" and "MD" in the tops and sides.
WARNUNG! - Die erste Accessoire-Sticks "KK" und "MD" in den Spitzen und an den Seiten.
POZOR! - První příslušenství holí "KK" a "MD" v korunách a boky.
POZOR! - Prvé príslušenstvo palíc "KK" a "MD" v korunách a boky.
ВНИМАНИЕ! - Первый аксессуаров палочки "KK" и "MD" по верхинам и по бокам.
DĖMESIO! - Pirmiausiai funitūrą KK ir MD įkalame į stalviršį ir šonus.