

# KOKKUPANEKUJUHEND / ASSEMBLY INSTRUCTION

## VARIKATUS LEGEND / GAZEBO LEGEND 09331, 09335

### TÄHELEPANU!

Antud varikatus on disainitud ainult vaba aja veetmiseks, mitte varju andma ebasoodsate ilmastikutingimuste korral.

- Ärge kasutage varikatust tuulise ilmaga.
- Ärge jätke varikatust järelvalveta.
- Jälgige tuleohutusnõudeid. Keelatud on grillimine ja ilutulestiku süütamine varikatuse all või selle vahetus läheduses.



















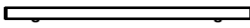



Hoidke juhend alles hilisemaks kasutamiseks.

### ATTENTION!

This gazebo is meant to be used for decorative and sunshade purpose only and is not meant to withstand all elements of the weather.

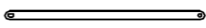
- Do not use when it is windy.
- Do not left without supervision.
- Be careful with fire safety. Do not cook or ignite fireworks underneath gazebo.

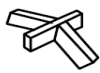
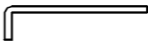
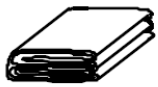
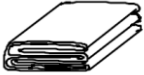
Retain the instruction for the further references.

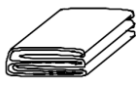
					
1. Küljepost 4tk 1. Standing pole 4pcs		2. Küljetala 2tk 2. Side pole 2pcs		3. Küljetala 2tk 3. Side pole 2pcs	
					
4. Küljetala 2tk 4. Side pole 2pcs	5. Küljetala 2tk 5. Side pole 2pcs	6. Katusetoru 4tk 6. Midmost rib 4pcs	7. Katusetoru 4tk 7. Upper top rib 4pcs		
					
8. Küljetala 4tk 8. Side rib 4pcs		9. Keskmine ülemine tala 1tk 9. Upper central top rib 1pc	10. Keskmine alumine tala 1tk 10. Lower central top rib 1pc		
					
A. M6x12 polt 60tk A. M6x12 bolt 60pcs	B. M6x45 polt 16tk B. M6x45 bolt 16pcs	C. M6x 25polt+seib+mutter 8tk C. M6x25 bolt+nut+cap 8sets	D. M6x 65polt+seib+mutter 4tk D. M6x65 bolt+nut+cap 4sets		
					
E. Jalatugi 4tk E. Under pan 4pcs	F. Liides 4tk F. Joint 4pcs	G. Nurgaliides 4tk G. Angle 4pcs	H. Ühendus 8tk H. Rib connector 8pcs		
					
I. Diagonaaltugi 8tk I. Crossing rib 8pcs	J. Risttugi 4tk J. Long bar 4pcs	K. Ühendus 2tk K. Top joont plate 2pcs	L. Ühendus 2tk L. Central connector 1pc		
					
M. Ankur 8tk M. Ground nail 8pcs	N. Katus 1tk N. Top cover 1pc	O. Katus 1tk O. Cover 1pc	P. Konks 112tk P. Hook 112pcs	Q. Võrk 4tk Q. Net 4 pcs	R. Külg 4tk R. Side wall 4pcs

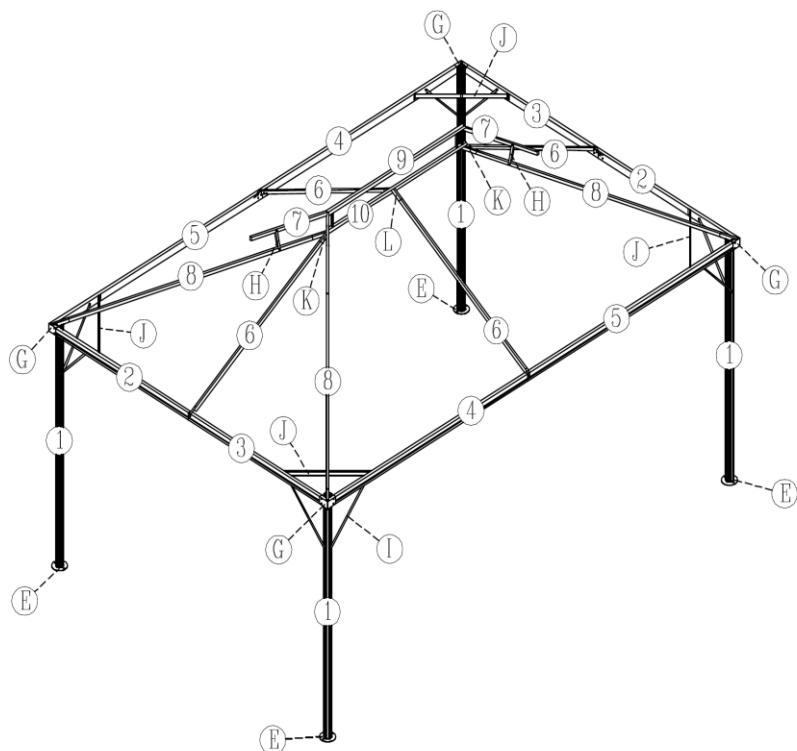

**Samm 1 / Step 1**

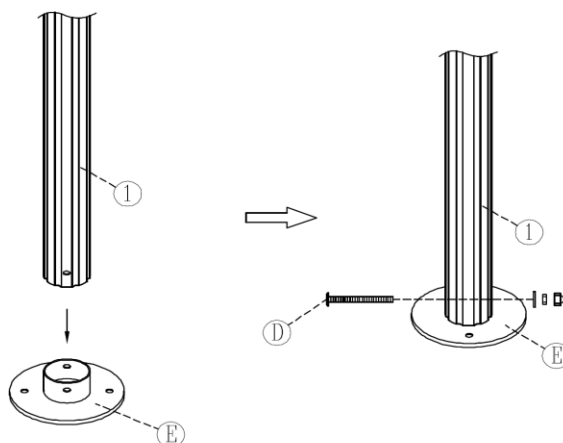

**Samm 2 / Step 2**

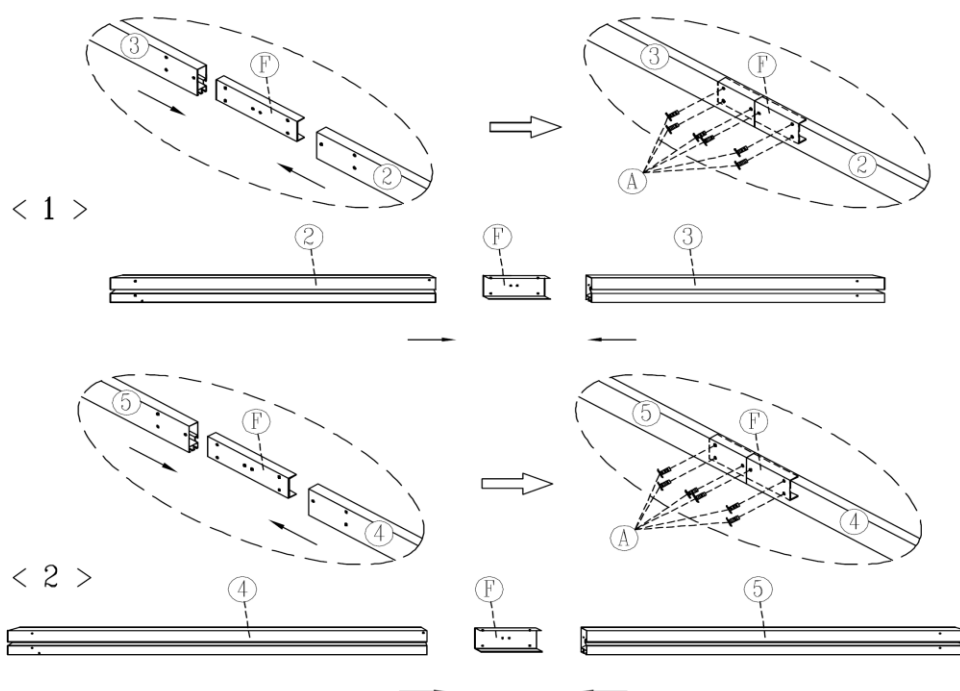

Samm 3 / Step 3

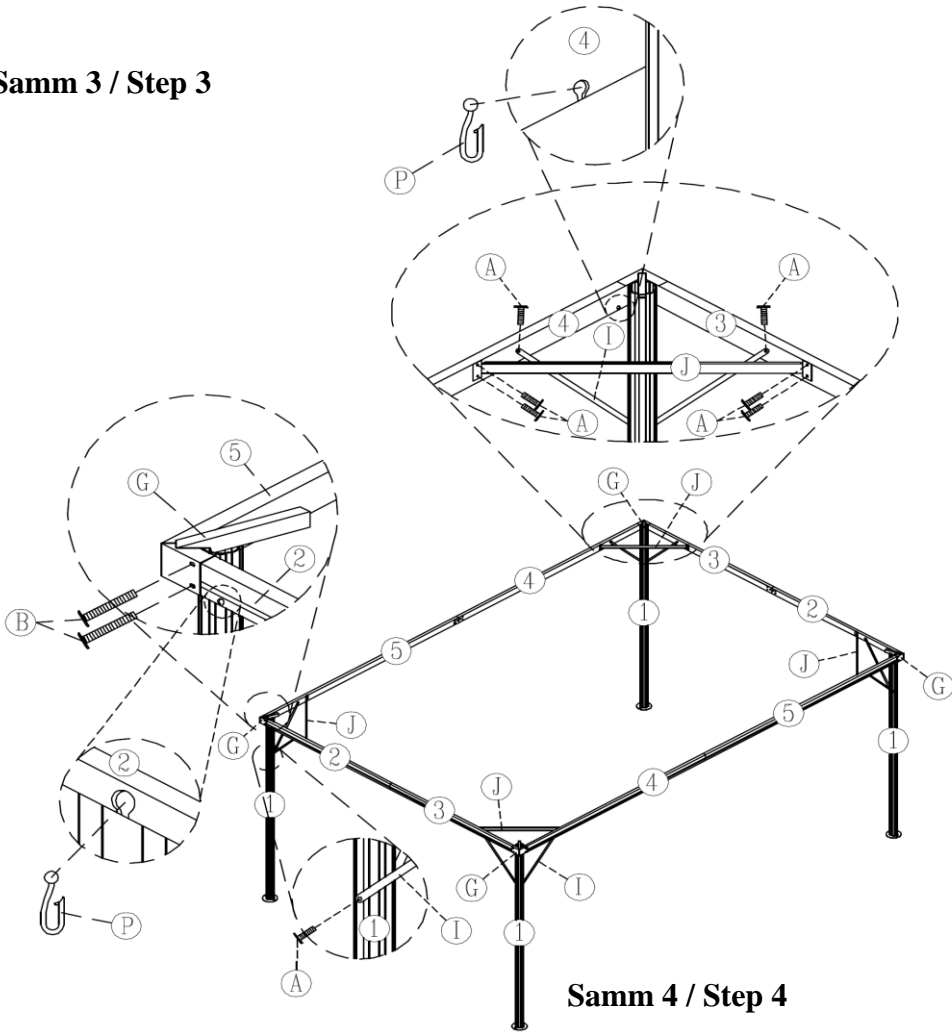

Samm 4 / Step 4

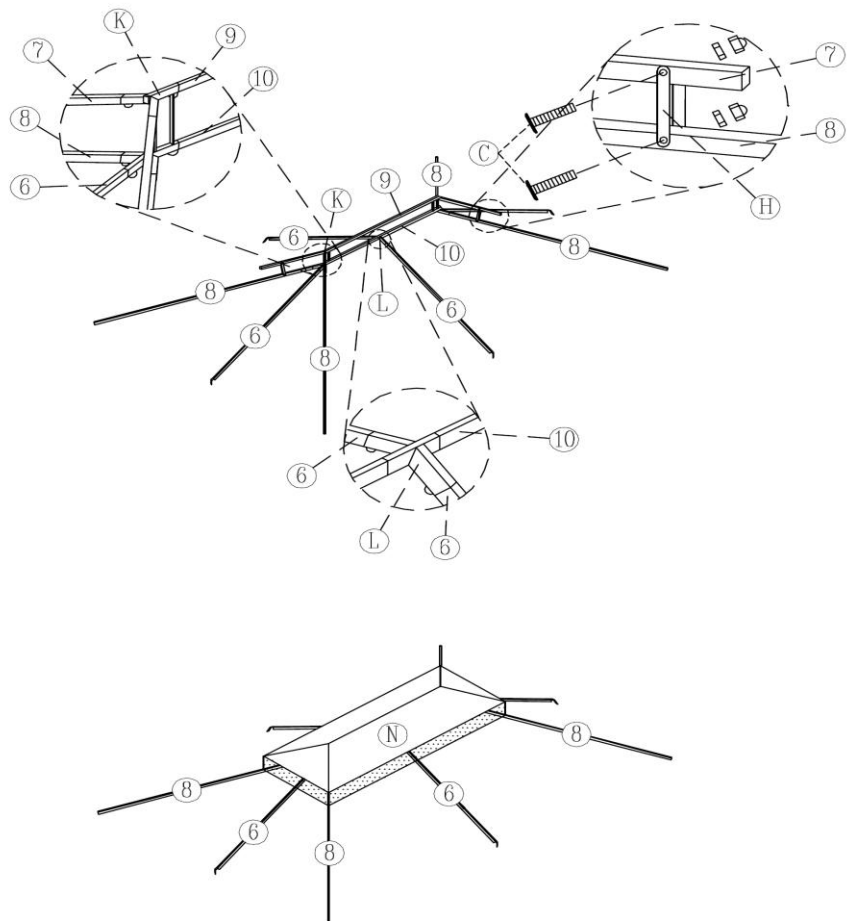

Samm 5 / Step 5

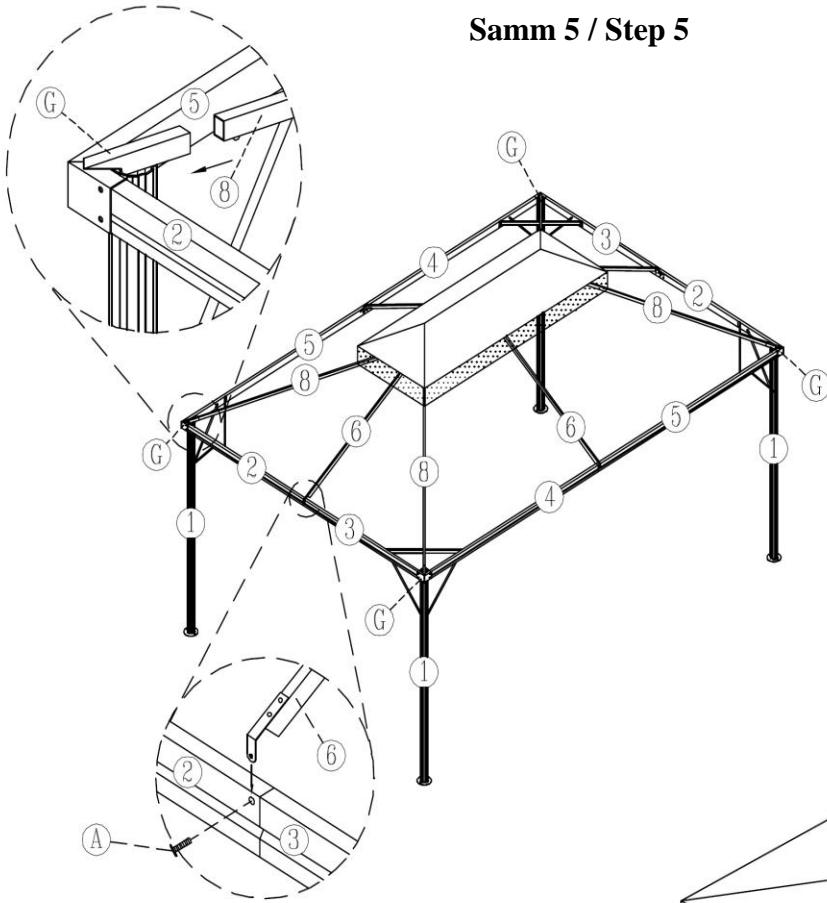

Samm 6 / Step 6

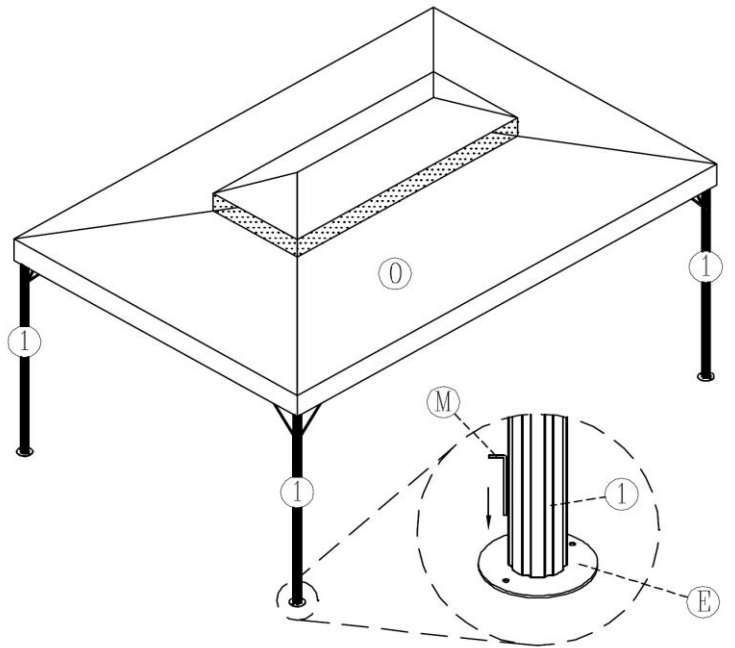

Samm 7 / Step 7

