

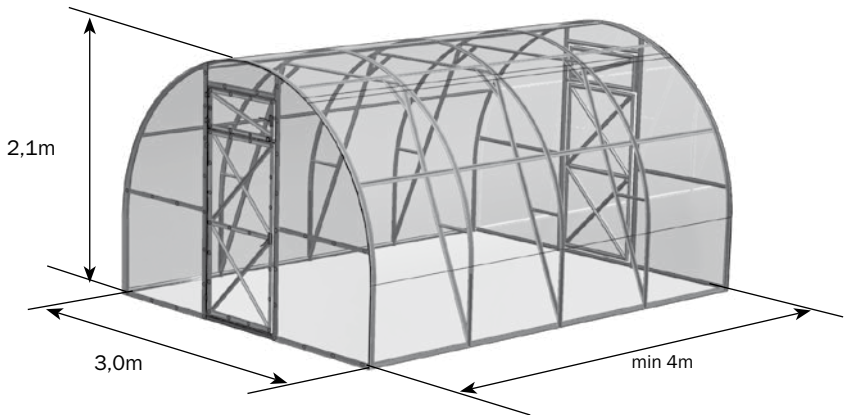

KASVUHOONE STRONG





Kasvuhoone paigaldamisel ja kasutamisel pidage rangelt kinni juhendist ja ohutusjuhistest

Kasutusjuhend

Enne kasutamist tuleb kasvuhoone vastavalt paigaldusjuhendile kokku panna ja pinnasele paigaldada. Kui kasvuhoone paigaldavad kolmandad isikud peab ostja kontrollima paigalduse kvaliteeti, et lõpptulemus vastaks juhendis toodud joonistele. Karkassi kokkupanemisel detaile ühendades tuleb ära kasutada kõik ettenähtud avad. Detailide „lihtsustatud“ ühendamine ühe-kahe poldiga (kahe-nelja asemel on paigaldusreeglite rikkumine ja seetõttu kaob tootel tootjapoolne garantii). Kokkupanemisel olge ettevaatlik, et detailid enne paigalduse lõppu ei deformeeruks. Jälgige kokkupanemisel, et kasvuhoone karkass oleks ühtlaselt üles tõstetud. Avade rihtimiseks kasutage koonuselise otsaga kärna või 4 mm läbimõõduga naela.

Ärge paigutage kasvuhoonet hoonete ja puude lähedale millelt võib kukkuda lund või jää. Soovituslik vahekaugus on minimaalselt 2m.

Kasvuhoone talub kuni 24 m/s puhuvat puhangulist tuult. Tugeva tuule puhul ning talveks peavad kasvuhoone ukсед, aknad ja katuseleuugid kinnises asendis olema ja tugevalt suletud (et ei logiseks).

Talveks ei ole vaja kihtplastiku lehti kasvuhoonelt eemaldada. Talveperioodil ei ole kasvuhoone lumekoormuse kontrollimine vajalik, kuid lumerohkete talvede puhul võiks seda siiski teha. Vajadusel tuleb liigne lumi katusele ja külgedelt eemaldada. Karkassi puhul, mis on täielikult komplekteeritud ja juhendi järgi kokku pandud on piirlumekoormus 180 kg horisontaalse maapinna ühe ruutmeetri kohta.

Kihtplastiku plaatide puhastamine ja pesemine.

1. Enne pesemist loputage sooja veega.
2. Kihtplastikut tuleb pesta seebilahuse või spetsiaalse puhastusvahendi- ja sooja veega, kasutades mustuse eemaldamiseks pehmet lappi. Kõige paremini sobib plastiku puhastamiseks spetsiaalne plastiku pesuvahend (küsige müüjalt).
3. Loputage külma veega ja kuivatage vajadusel pehme lapiga.



- nool näitab paigaldamise suunda vastavalt juhendi skeemile. Detailide ülekattega ühendamisel ei ole tähtis milline detail on peal. Mõned poltide avad võivad jääda kasutamata. Ärge laske sellest end häirida kuna see on tingitud tootmisprotsessist ja kondensaadi väljajuhtimiseks.

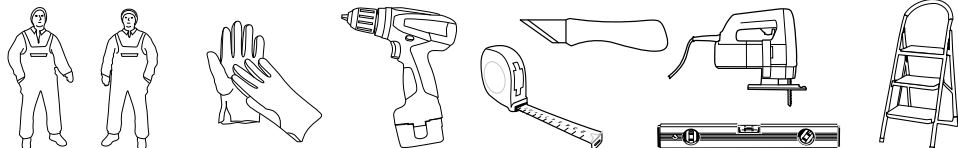

Kasvuhoone karkass on valmistatud tsingitud rauast ning see pannakse kokku poltide ja mutritega. Kasvuhoone kinnitatakse maapinnale karkassi spetsiaalsete otsadetailide maasse kaevamisega või vundamendi külge kinnitamiseks mõeldud nurkraudadega (ei kuulu komplekti). Baaskomplekt sisaldab kõike vajalikku katteplaatide kinnitamiseks. Kasvuhoonel on kaks üksteise vastas asuvates otstes olevat ukseava ja tuulutusakent. Kasvuhoone baaskomplekti jaoks on vajalik 3 kihtplastiku lehte pikkusega 6 meetrit ja laiusega 2,1 meetrit (vaikimisi on komplektis 4mm paksune kihtplastik, kuid vastavalt ostja soovile on võimalik komplekteerida 6mm paksune kihtplastik). Iga 2 meetrise pikenduskomplekti jaoks on vajalik üks täiendav kihtplastiku leht.















Garantii















1. Tootja kannab vastutust kasvuhoone karkassi täieliku kompleksuse eest.
2. Tootja kannab vastutust selle eest, et kasvuhoone oleks vastavalt juhendile kokkupandav.
3. Tootja kannab vastutust kasvuhoone vastupidavuse eest toodud ilmastikumõjude juures.
4. Pretensioonide esitamise aeg – 24 kuud alates ostmise kuupäevast.



Garantiitingimused

Garantii ei kehti, kui:





1. Kasvuhoone on paigaldatud juhendit eirates.
2. On rikutud kasutusjuhendis välja toodud reegleid.
3. Kasvuhoonet on kasutatud muuks otstarbeks kui aiakultuuride kasvatamine.
4. Kasvuhoone on deformeerunud pinnase liikumise tõttu.
5. On esinenud üleujutus, orkaan või juhtunud muu loodusõnnetus.

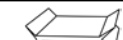







1	L=0,92 м		x10
2	L=0,96 м		x24
2в	L=0,96 м		x12
3	L=0,14 м		x14
4н	L=1,62 м		x6
4в	L=1,62 м		x3
4вк	L=1,62 м		x2
4нкп	L=1,62 м		x2
4нкл	L=1,62 м		x2
5	L=0,09 м		x4
8	L=1,04 м		x4
9-1	L=0,981 м		x4
9-2л	L=1,4 м		x2
9-2п	L=1,4 м		x2
10	L=0,82 м		x4





11-л	L=1,02 м		x2
11-п	L=1,02 м		x2
12д	L=0,756 м		x8
12ф	L=0,320 м		x4
13д	L=0,713 м		x6
13ф	L=0,713 м		x4
14	L=0,958 м		x4
15	L=1,0 м		x4
16	L=0,737 м		x2
17	L=1,4 м		x3
18	L=1,1 м		x6
19	L=0,99 м		x6
20	L=0,34 м		x6
21	L=0,35 м		x6

Hinge tihend		3,7 м
Ukse tihend		8 м
Otsa tihend		12 м

Tugevdustoru		x4
Kronstein		x8
Ukse- ja aknahaak		x4
Haagi kronstein		x8
Uste ja õhuakende hinged		x8
Pöördhoob		x4
Toru pöördhoova painutamiseks		x1
Käepide		x8
Keermestatud varras		x4

Profiil L=1,05m		x4
Profiil L=1,0m		x4
Ülemine metallist lai traat		x5
Alumine metallist lai traat		x10

Polt M4 x 8		x534
Polt M4 x 10		x50
Polt M4 x 25		x116
Polt M4 x 35		x32
Kruvi		x6
Mutter M4		x732
Seib M4		x144
Mutrivõti		x1
Kleeflint		x1

Polt M6 x 60		x10
Mutter M6		x10
Seib M6		x20
Kahepoolne kleeflint L=8,2m		x1

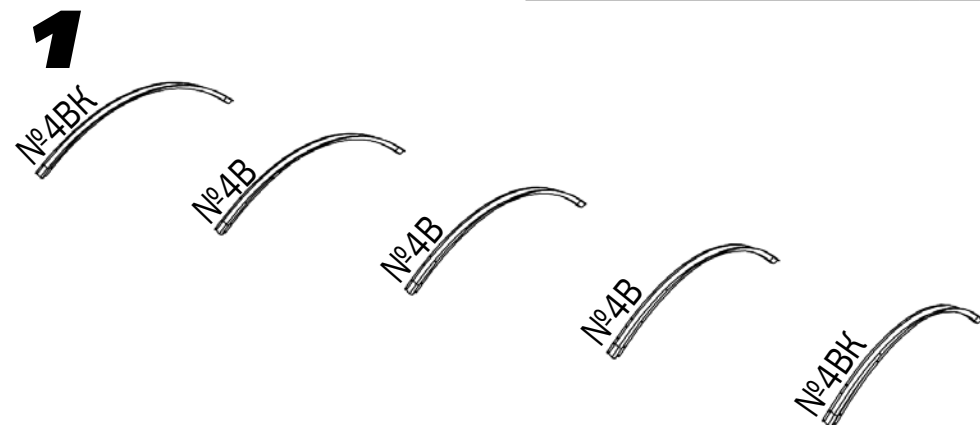

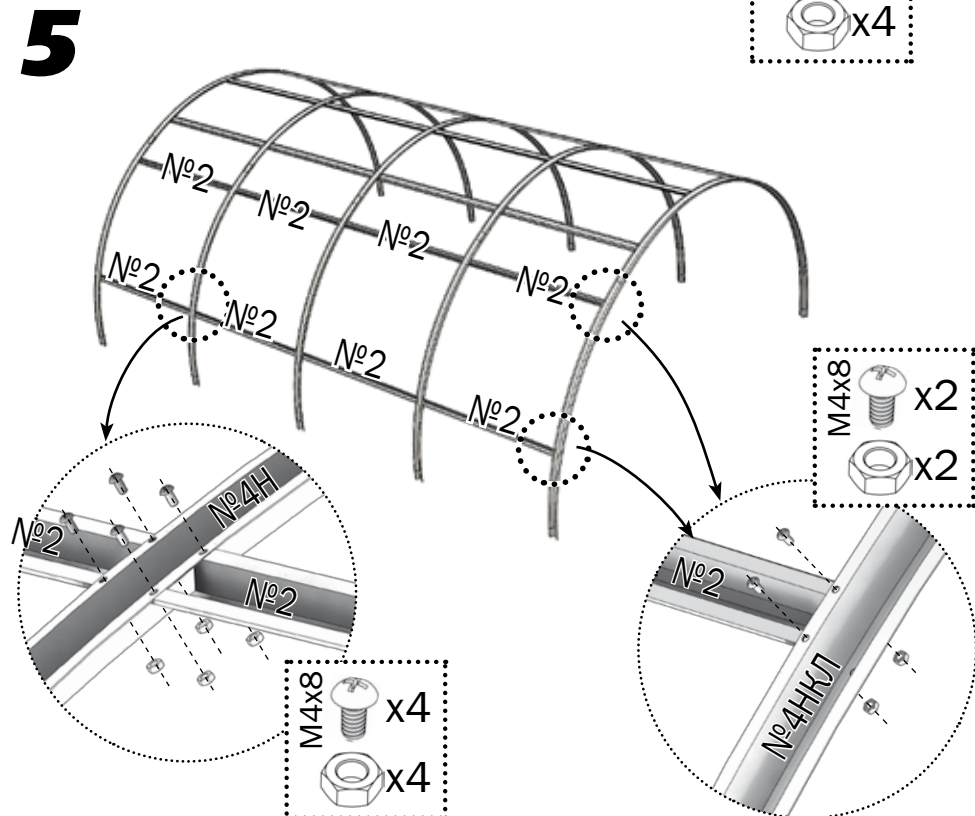
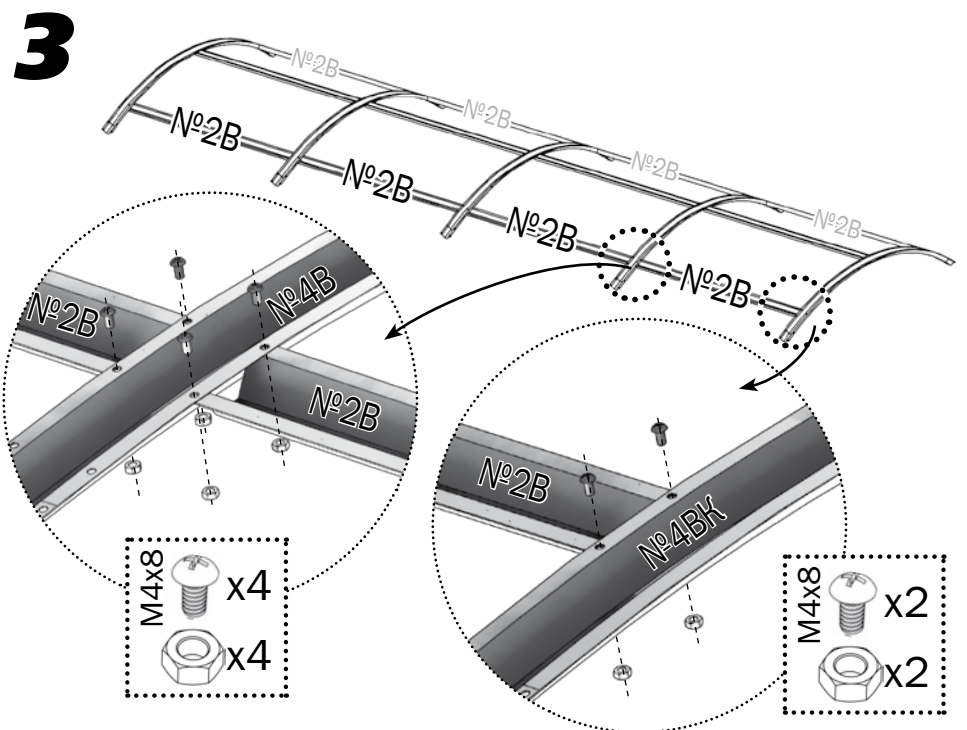
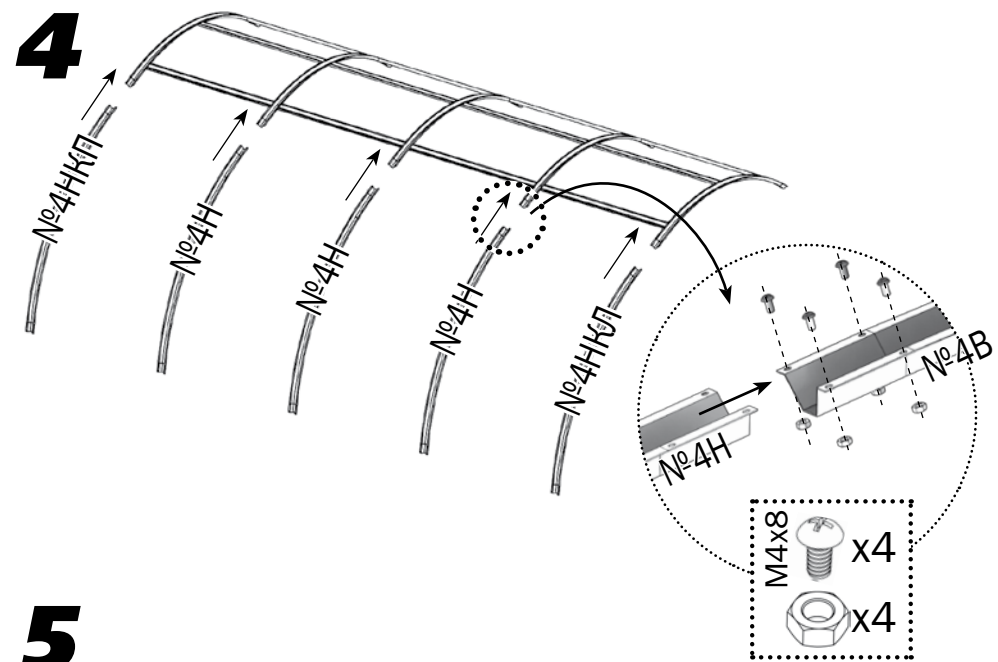
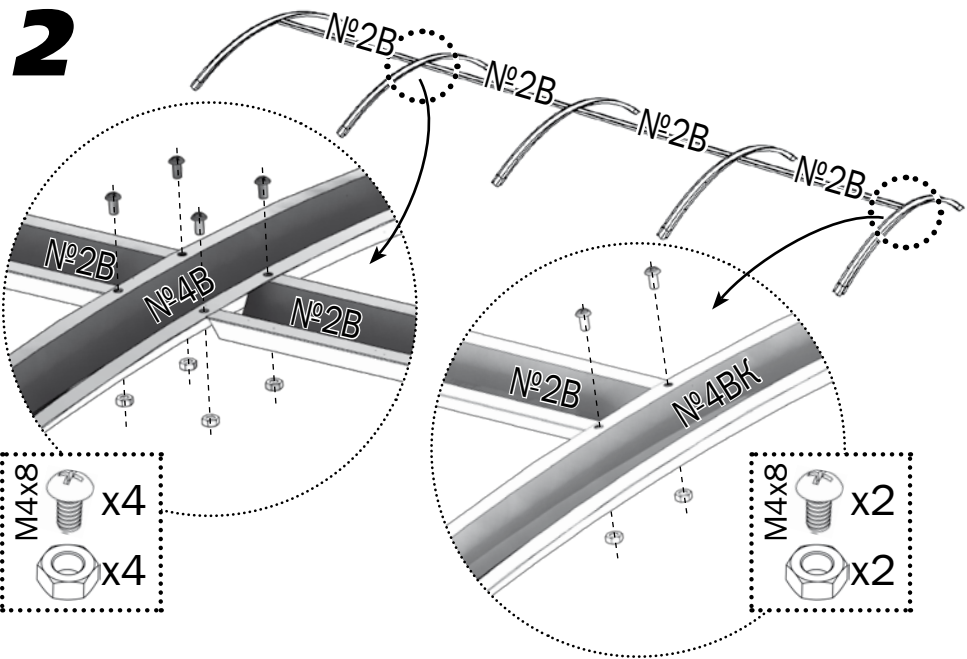

6

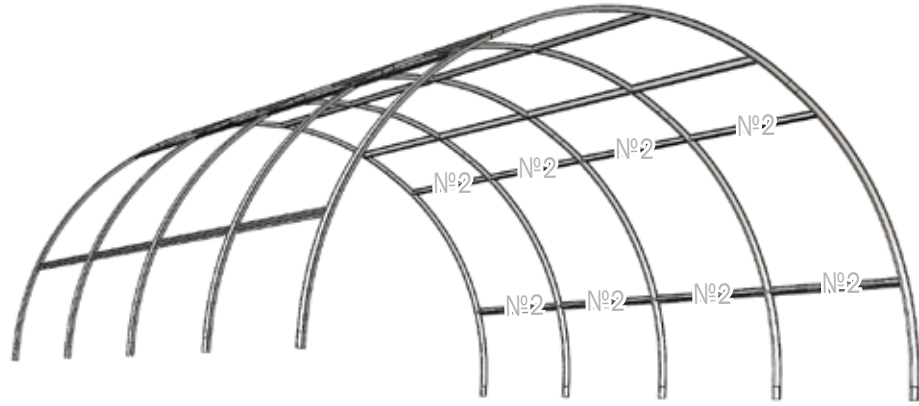

7

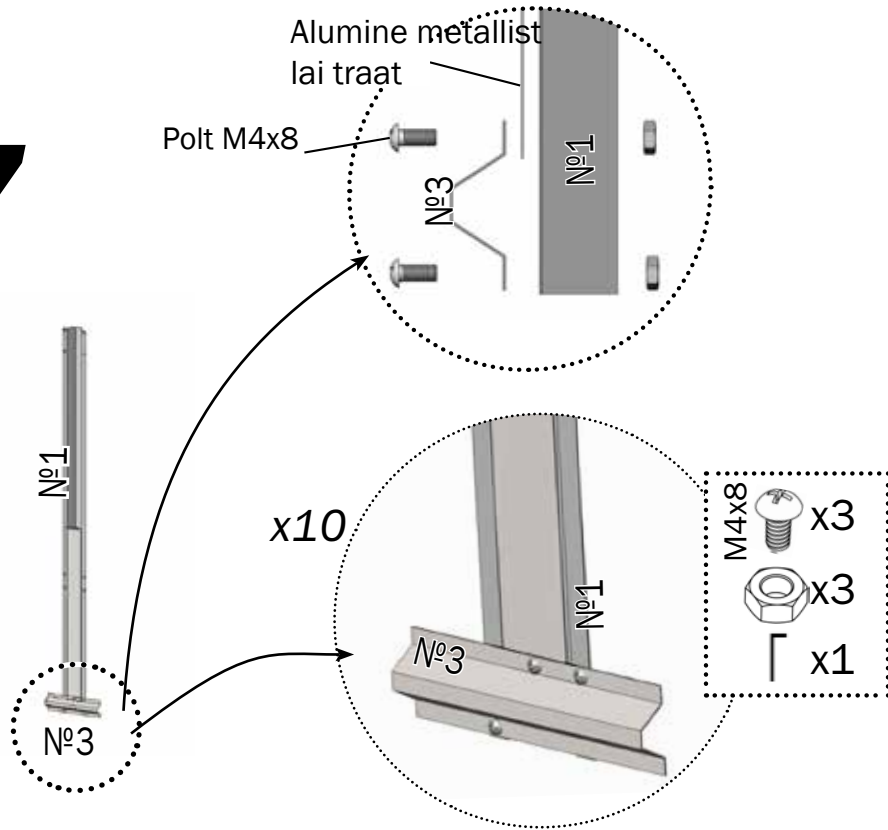

8

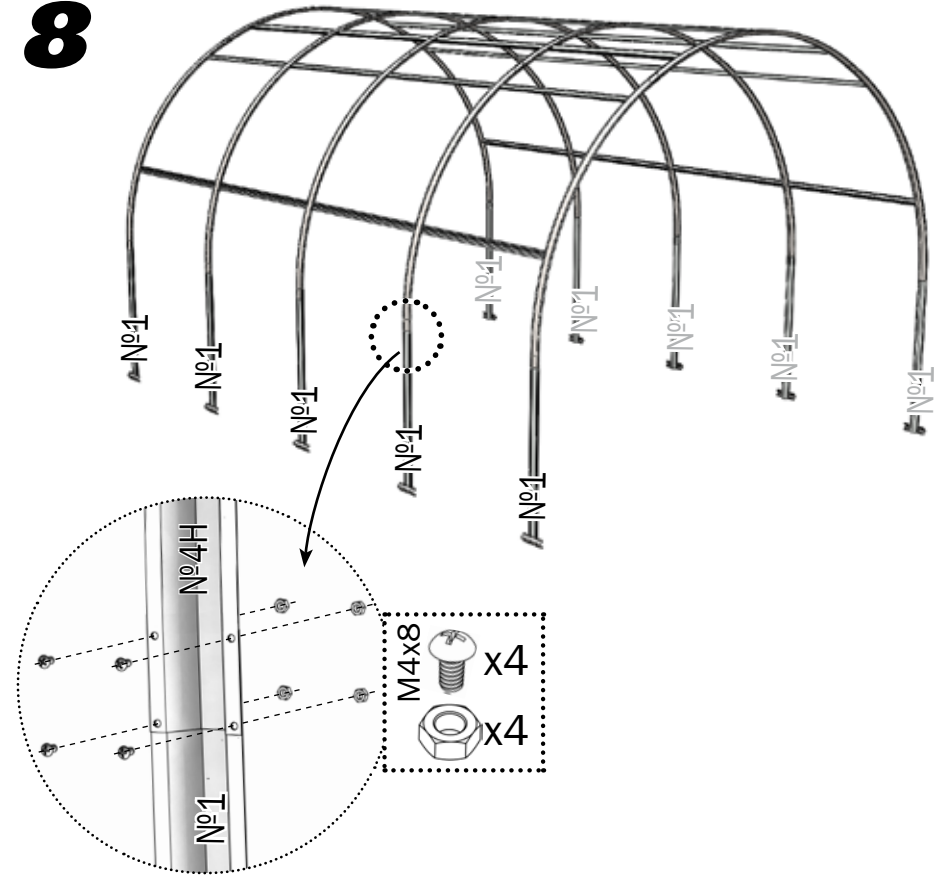

9

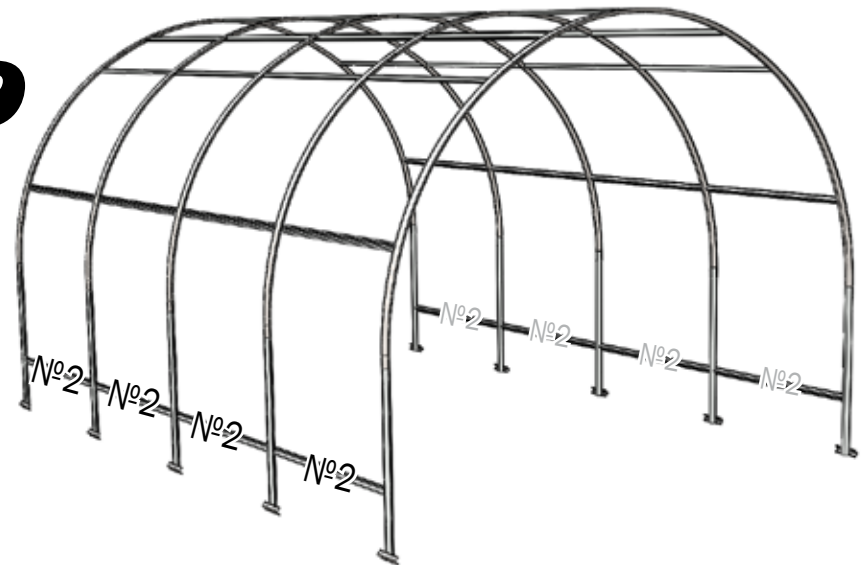

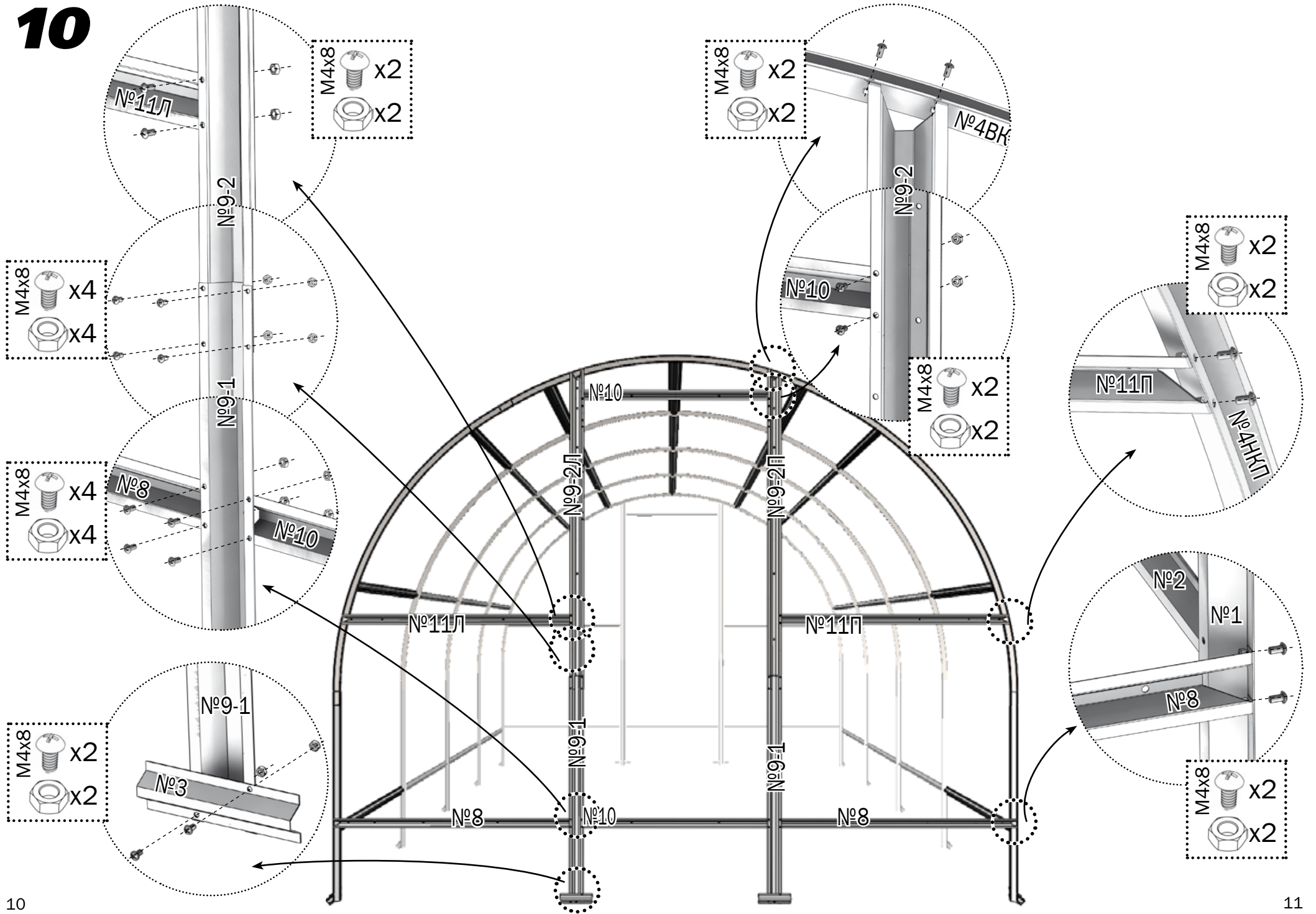

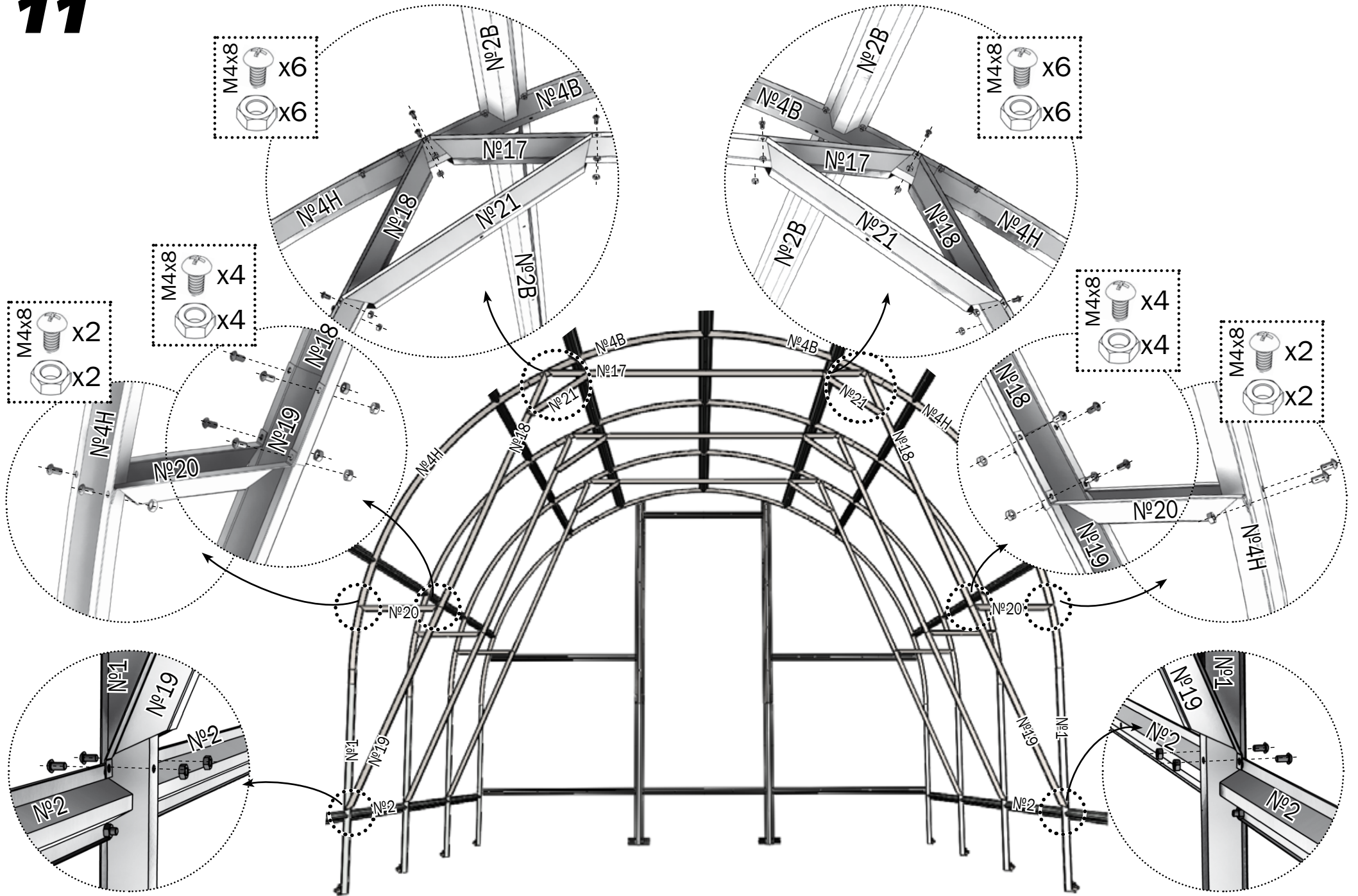

12

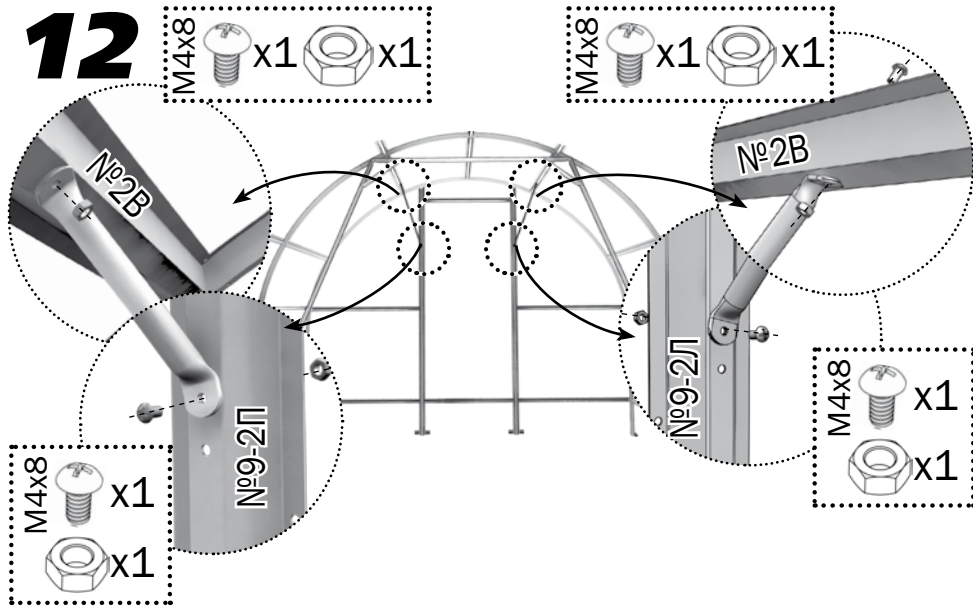

13

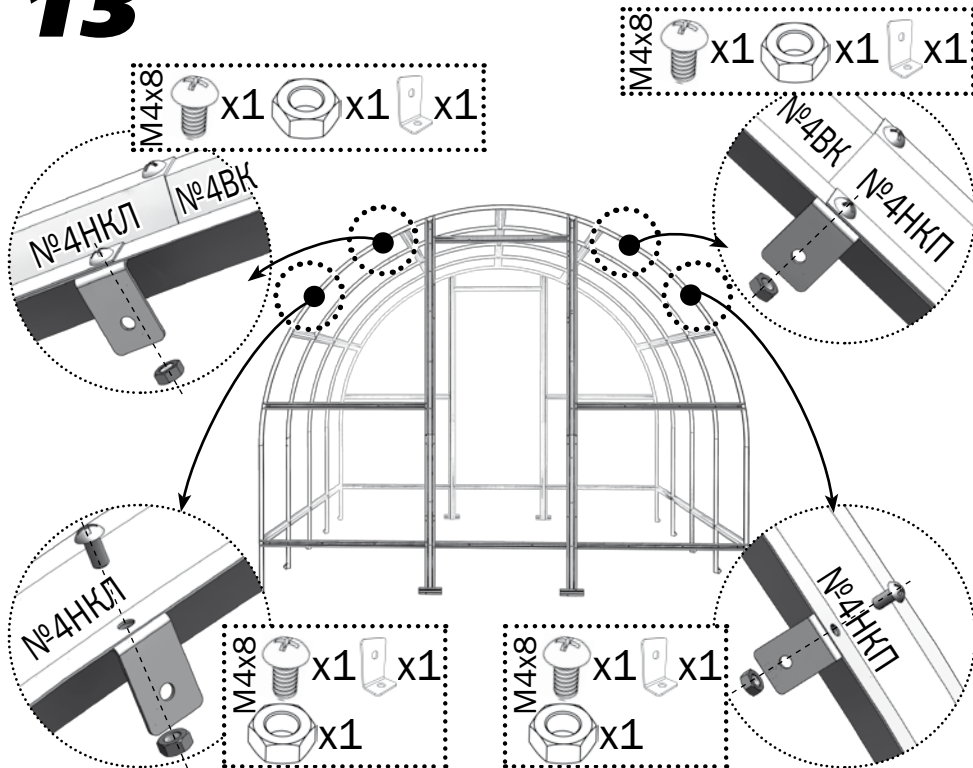

14

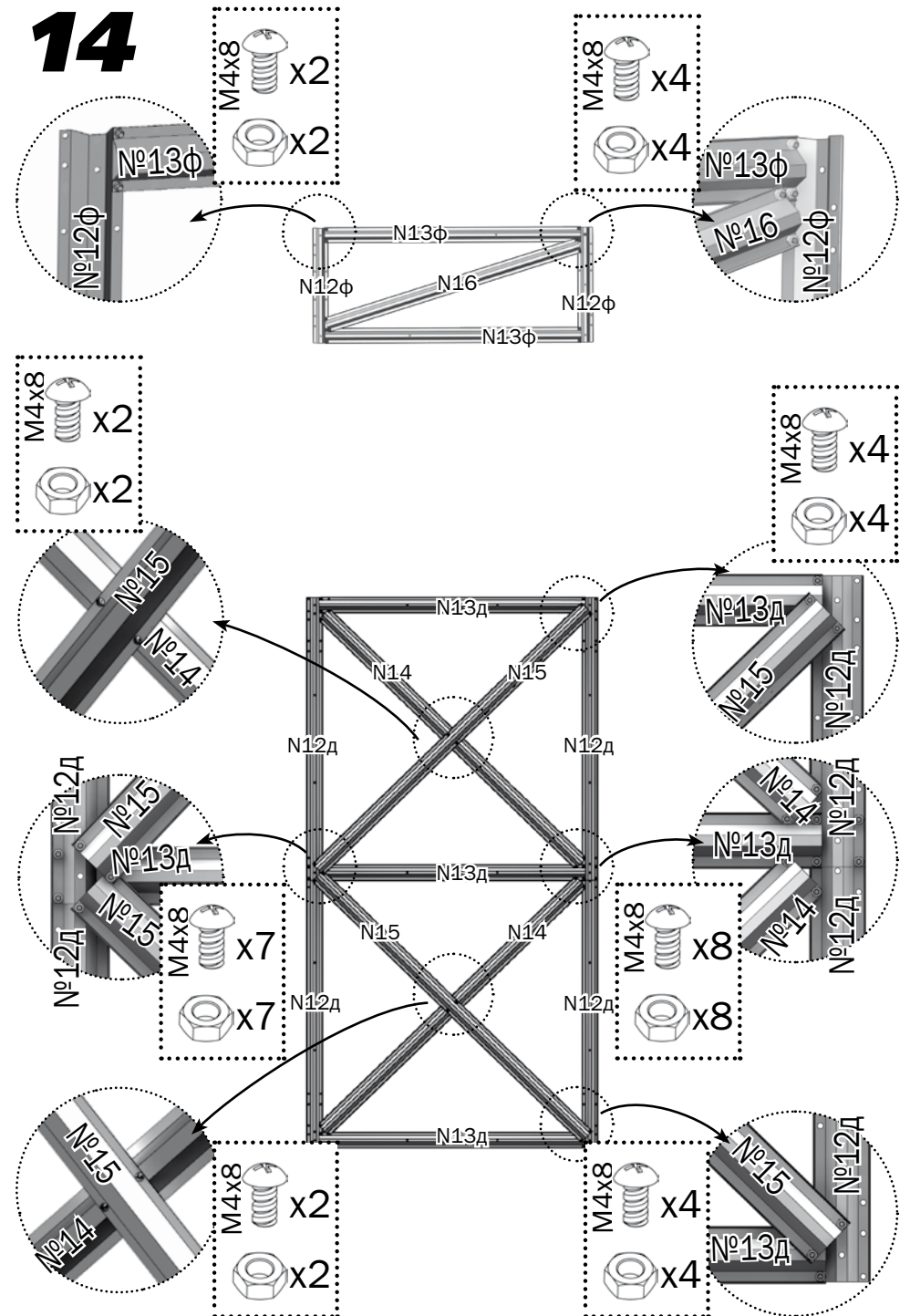

18

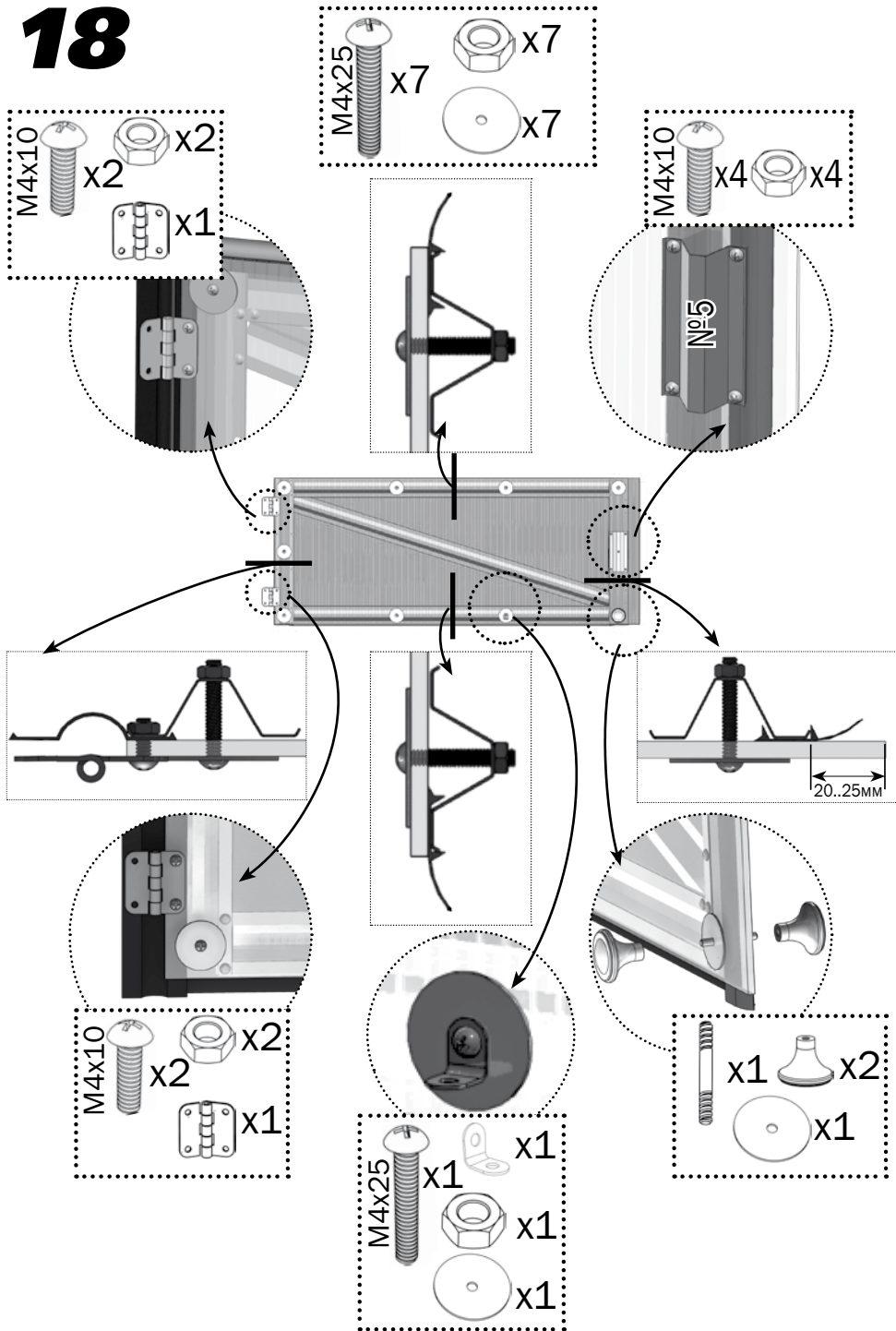

19

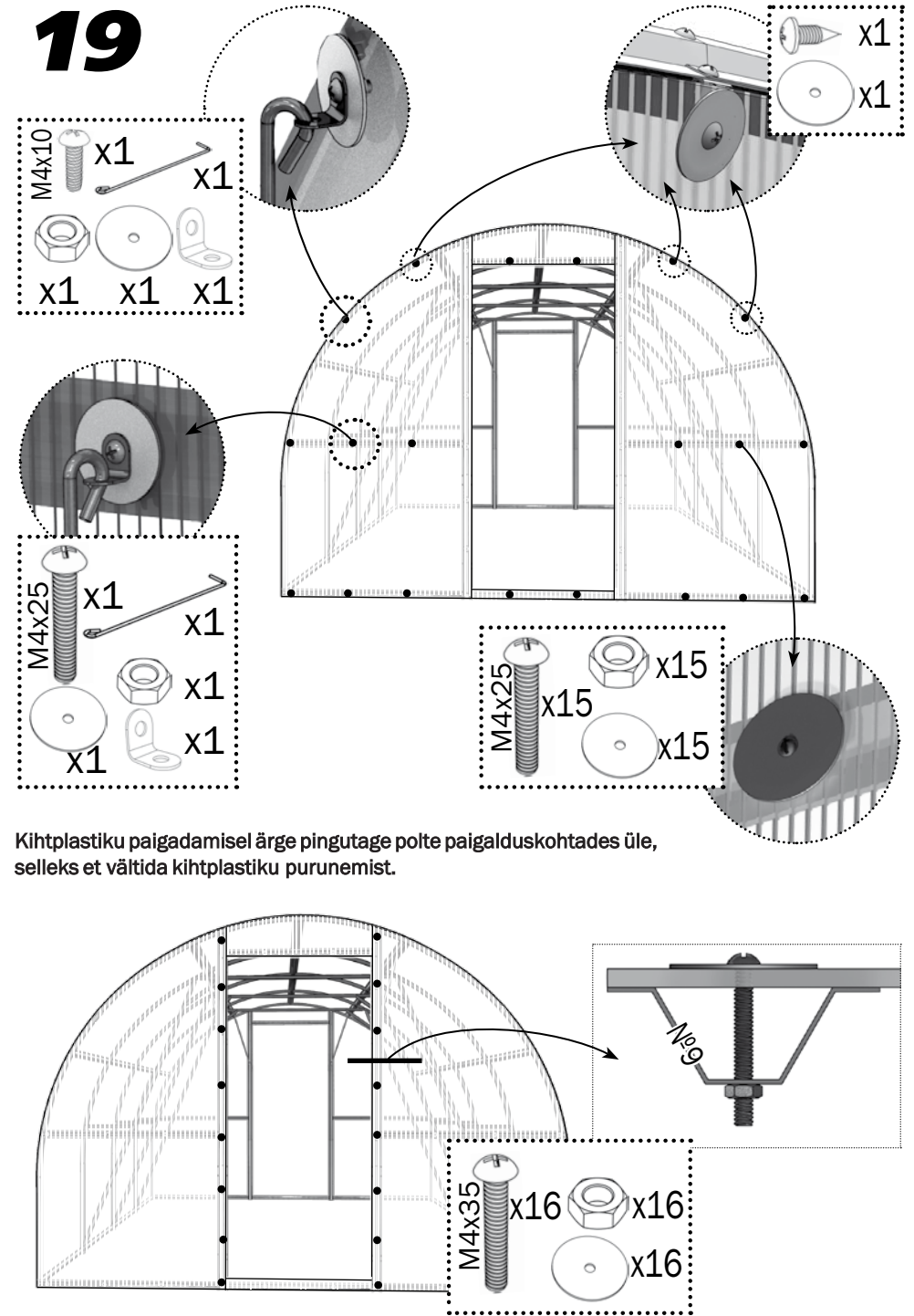

20

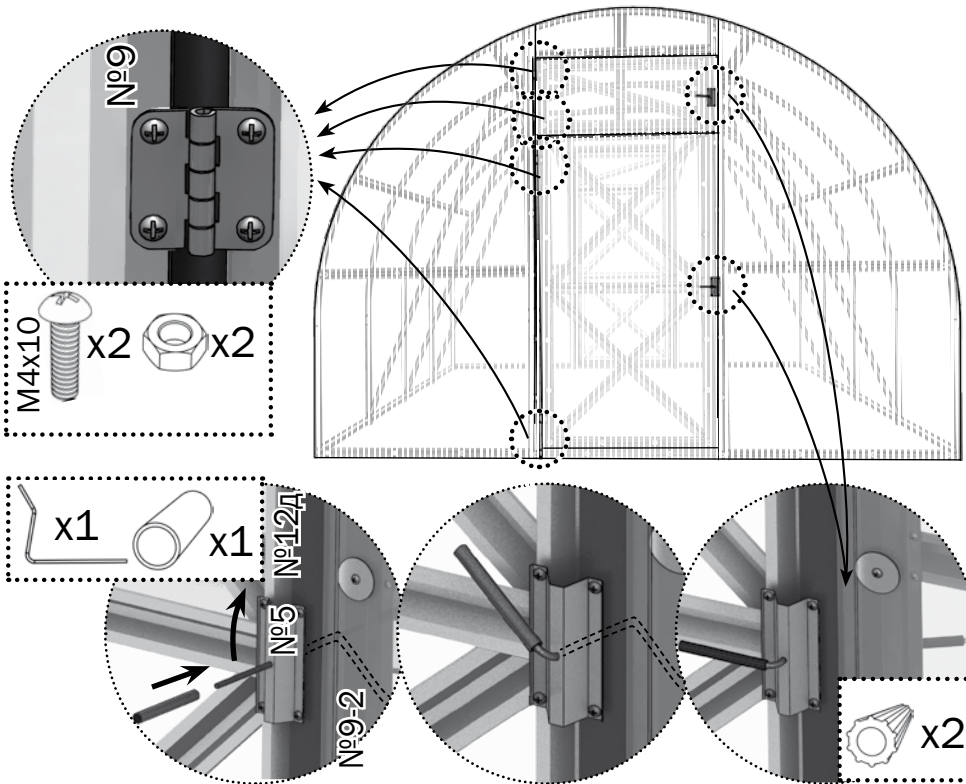

21 Tasandage kihtplastik kaarte järgi ning peale seda paigaldage plastikule tihend. Tihendi paigaldus võib oodatust kauem aega võtta.

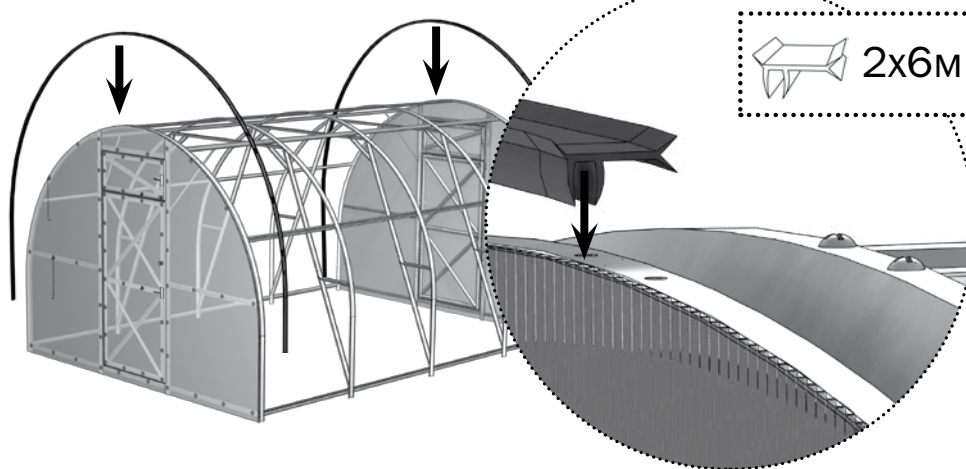

22

Kihtplastik paigaldatakse nii, et selle UV kaitsekihiga pool jääb päikese poole. UV kaitsekiht on reeglina sellel pool kus on transpordikilel tekst peal (või muu markeering või märgistus). Plaadi teisel küljel on kile läbipaistvam. Transpordikile eemaldamisel tehke täiendav märgistus küljele kus on UV kaitsekiht, selleks et pooled oleksid eristatavad. Transpordikile eemaldatakse mõlemalt küljelt vahetult enne plaadi kinnitamist karkassi külge. Kihtplastiku otsad tuleb kinni katta kas komplektis oleva kleeplindiga, Anti Dust teibiga ja/või U-profiliga

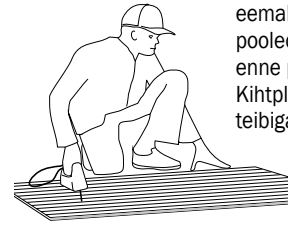

Kihtplastiku ääred tuleb kinni teipida.

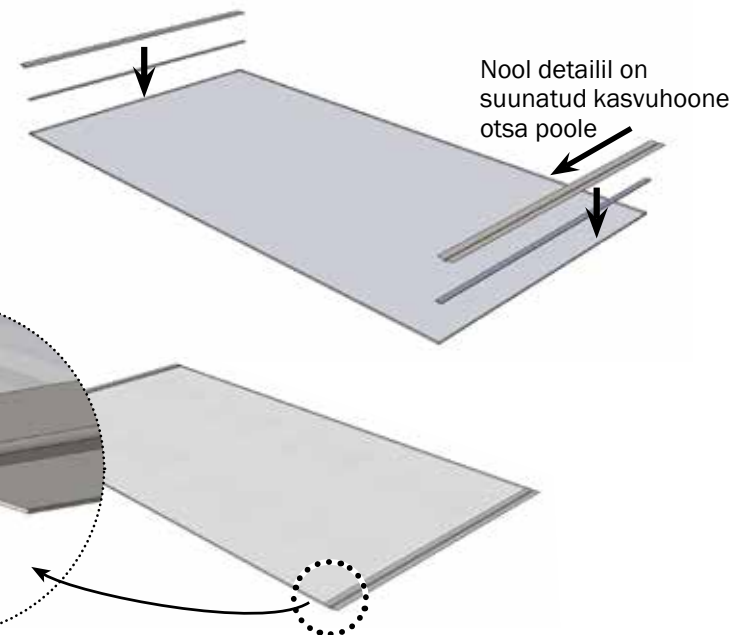
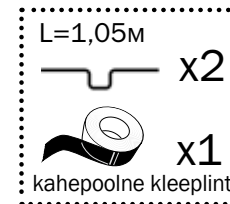
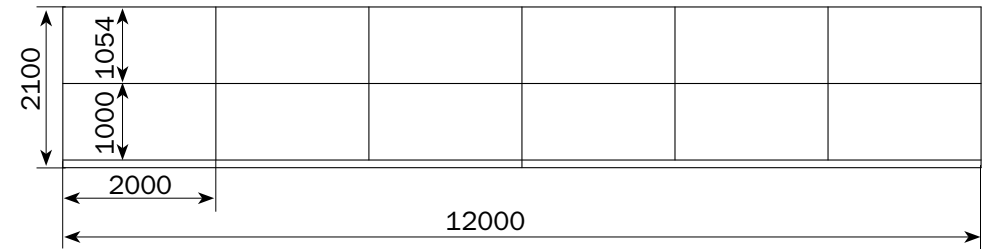
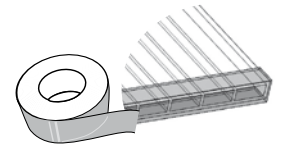

23

M4x25 x16
 x16

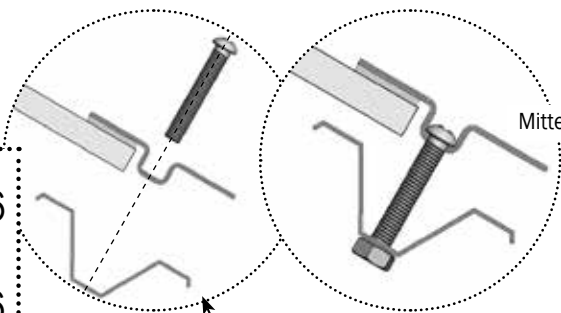

Mitte lõpuni kinni keerata!

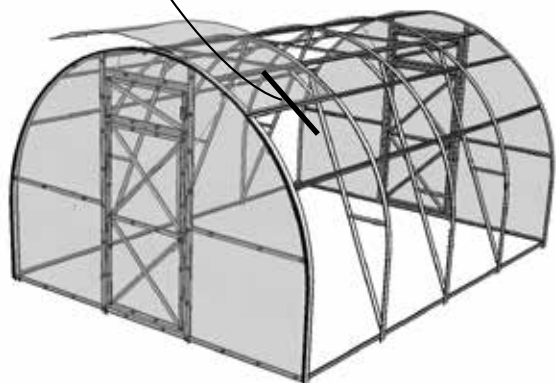

25

● - kihtplastiku kinnituskohad

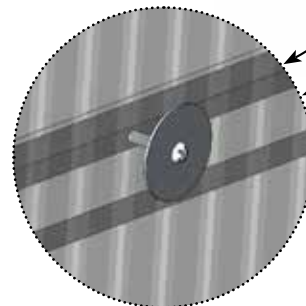
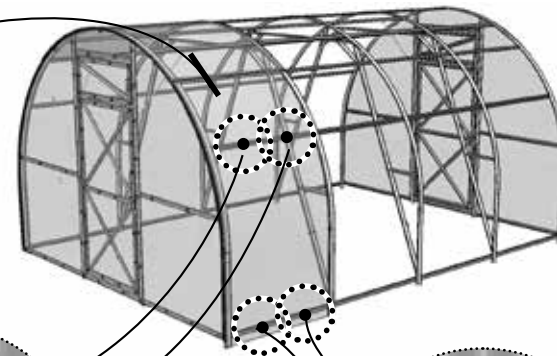
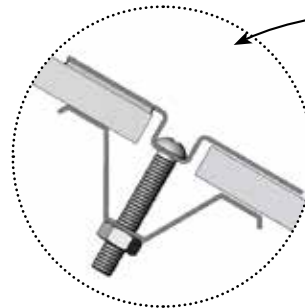

põhi-komplektist
 M4x25 x2
 x2
 x2

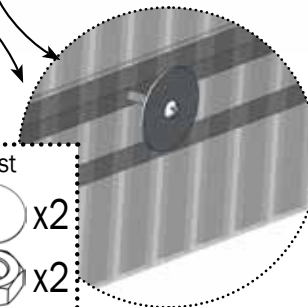

24

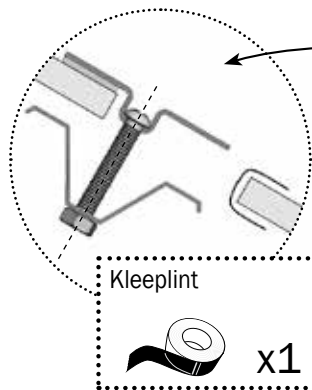

Kleeflint

x1

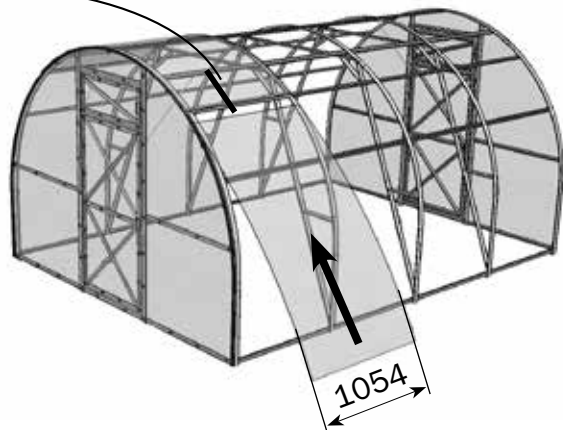

1054

26

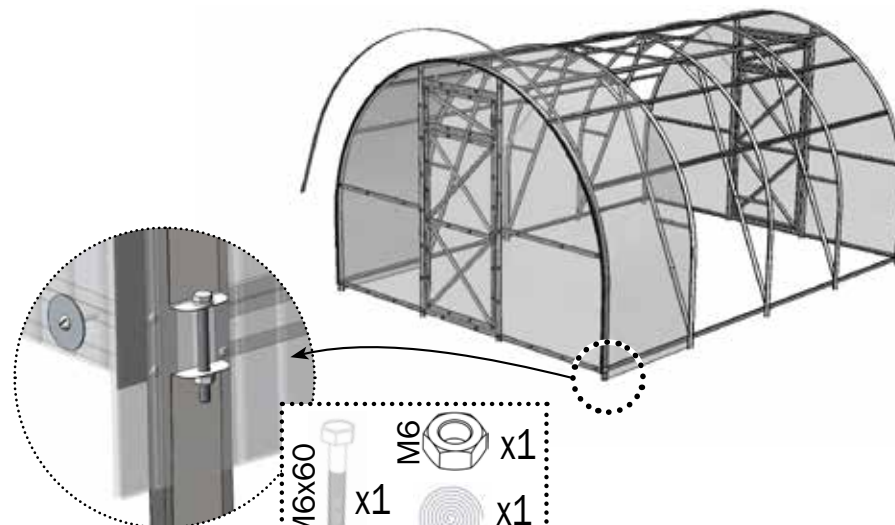

M6x60 x1
 M6 x1
 x1
 x2

27

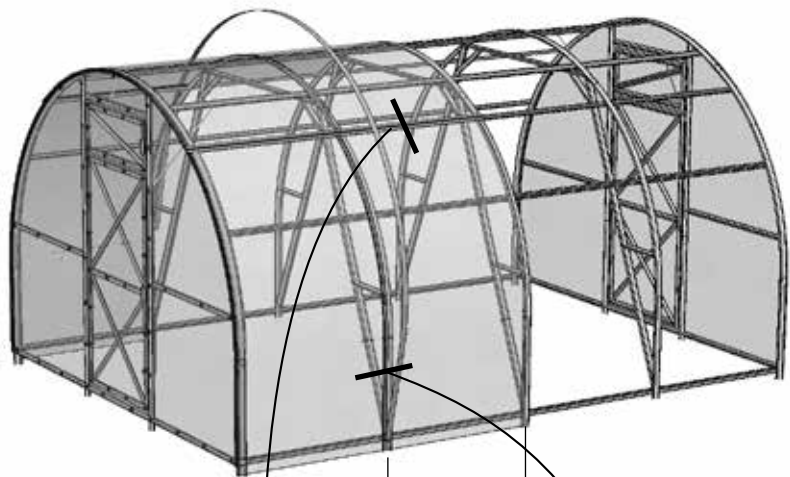

1000

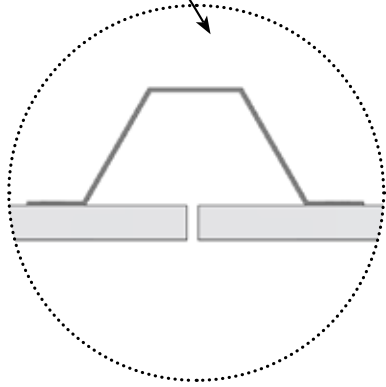
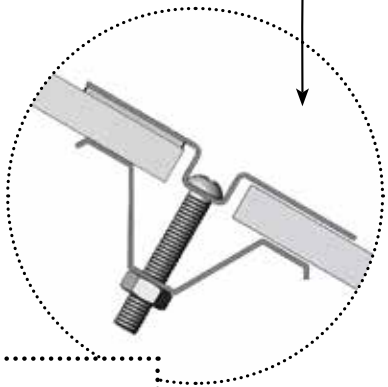

- 1 M x1
- M4x25 x3
- x3

28

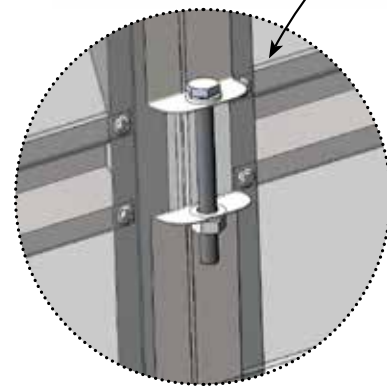
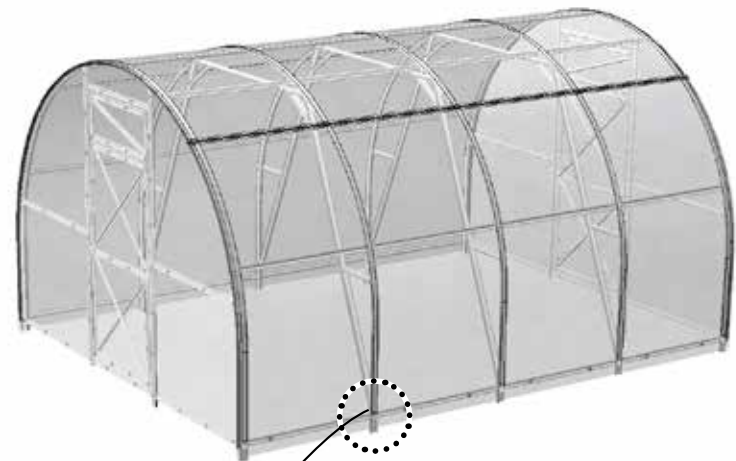

VUNDAMENDILE PAIGALDAMISEKS

