





NR 1

B1  8x28 x16

M1  x12

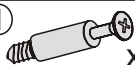
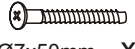
T1  x12

K1  Ø7x50mm x4

C2  x8

W1  x12

J23  x12

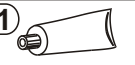
L1  x1

NR 2

F33  x12

P13  3,5x13 x48+8

F12  x2

G5  x12

S4  3,0x20 x15

S6  4,0x30 x6

F15  x6

NR 3

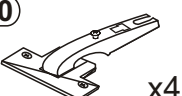
Y0  x4

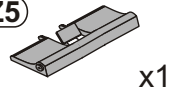
Z5  x1

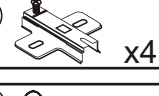
D7  x4

E3  6,3x13 x8

S8  4x13 x8

NR 4

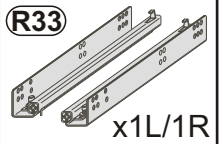
R33  x1L/1R

E24  6,0x11 x4

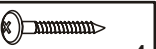
P7  4x30 x4

T2  5x35mm x2

M2  12x10mm x2

NR 5

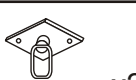
U22  x2

A18  4,0x25 x2

NR 6

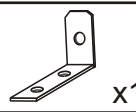



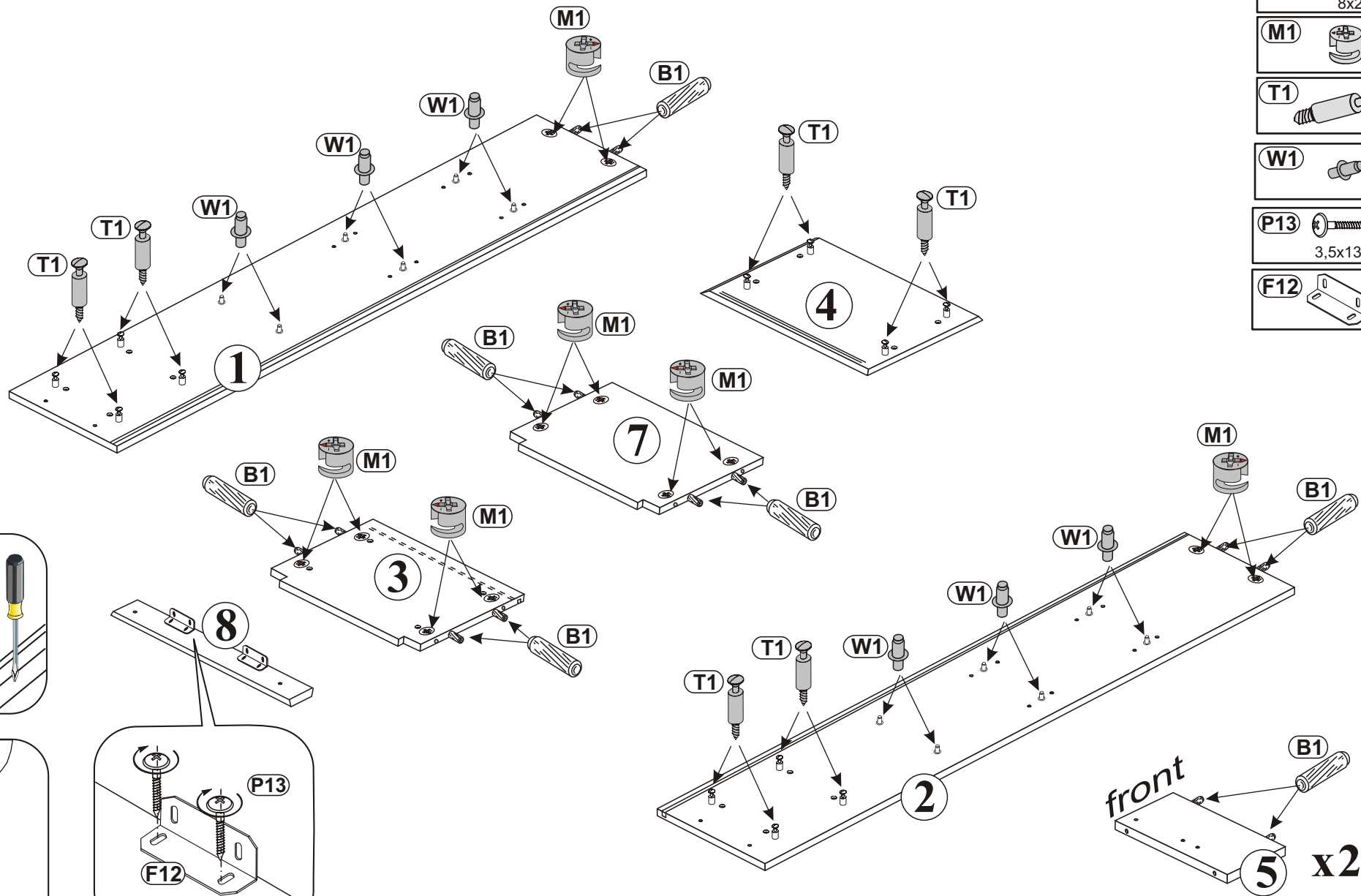

J11  x1

P13  3,5x13 x2



1



| | | | |
|------------|---|--------|-----|
| B1 |  | 8x28 | x16 |
| M1 |  | | x12 |
| T1 |  | | x12 |
| W1 |  | | x12 |
| P13 |  | 3,5x13 | x4 |
| F12 |  | | x2 |

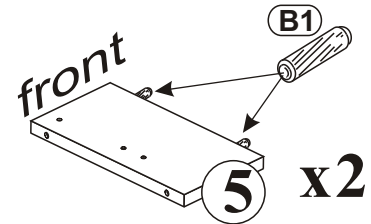
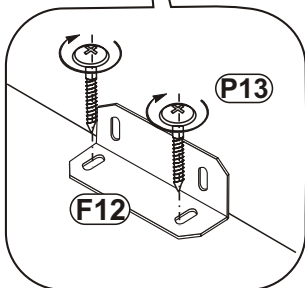
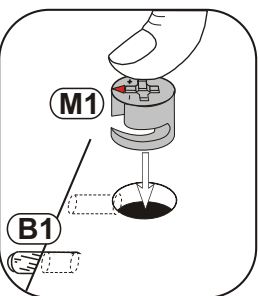
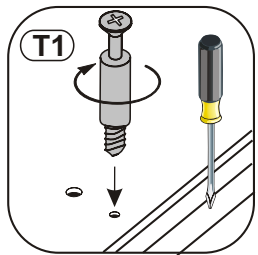

2

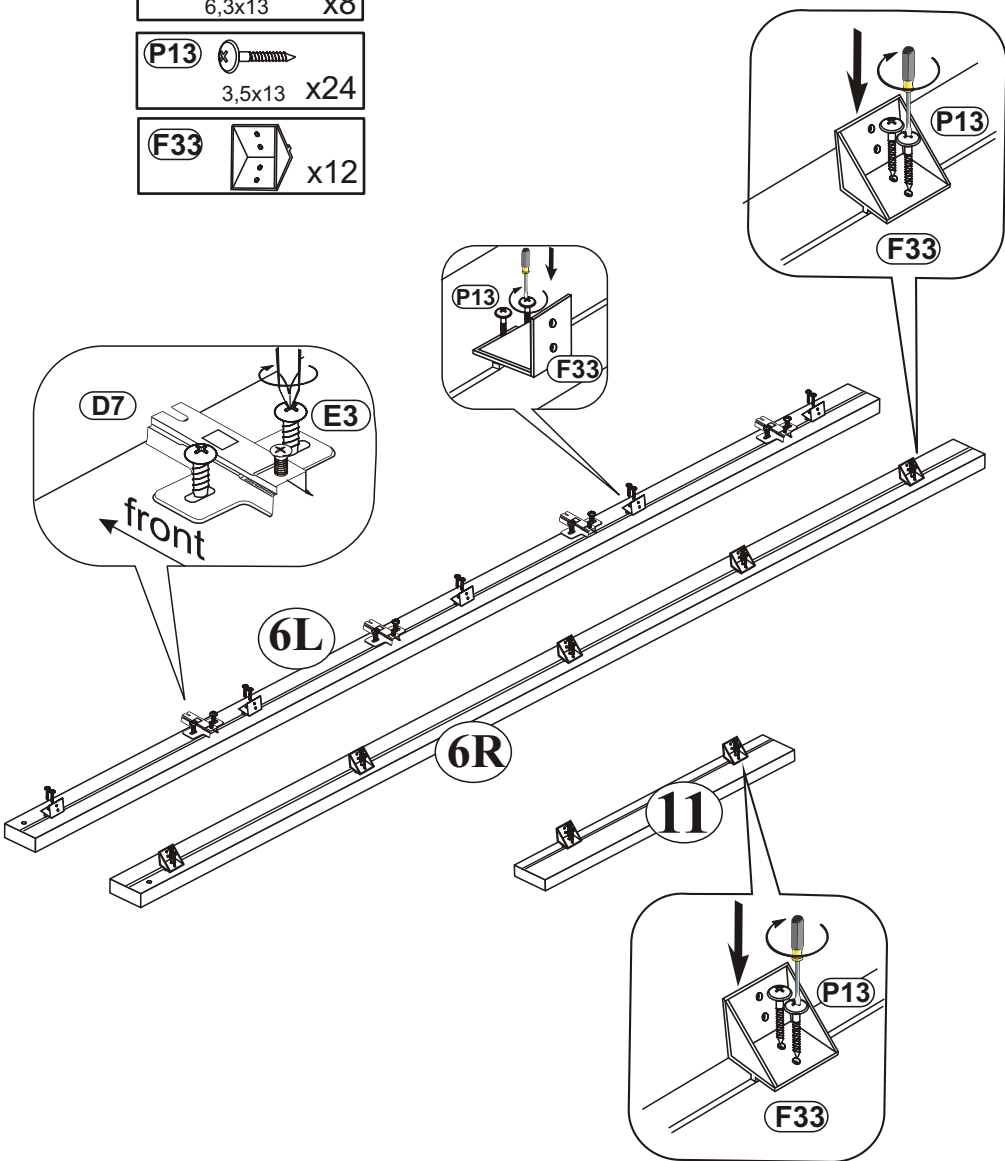
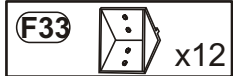
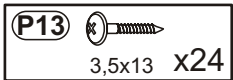
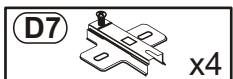

3

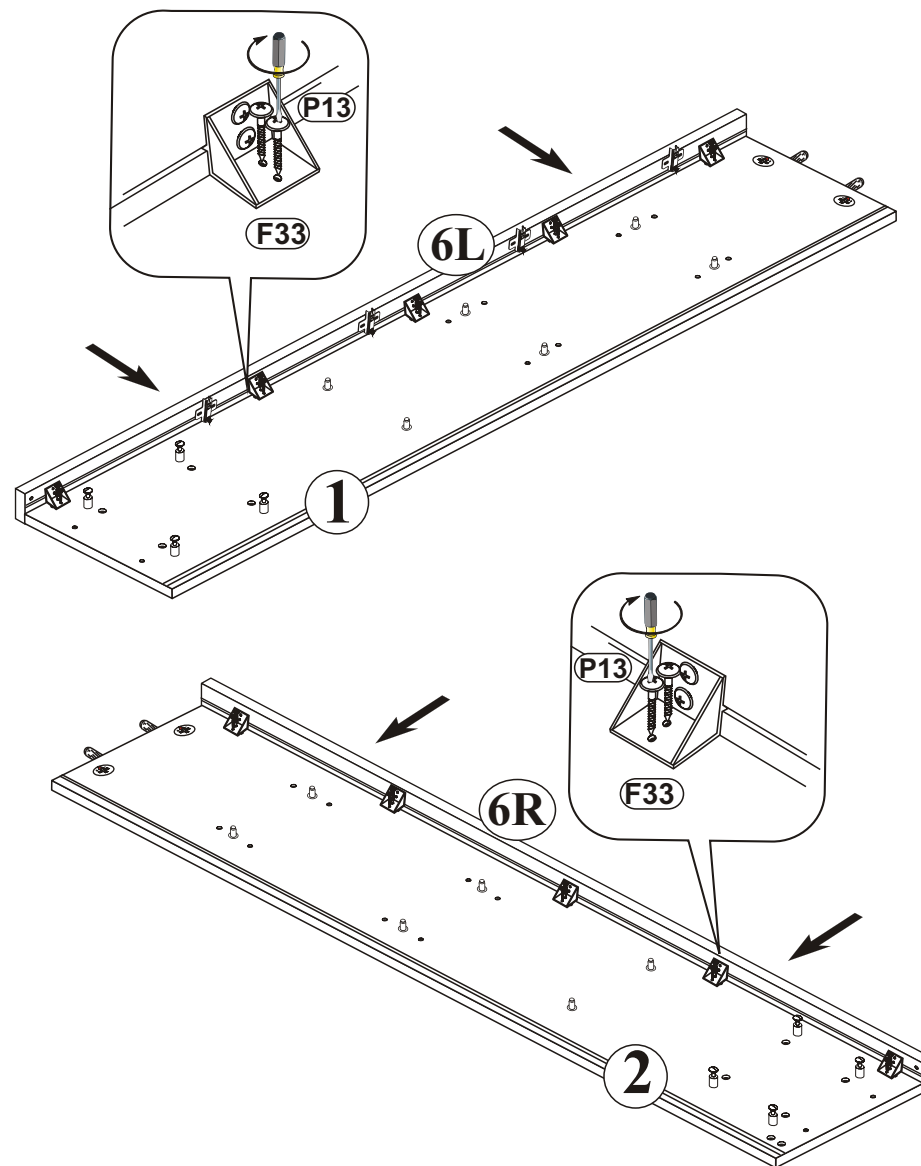
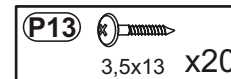

4

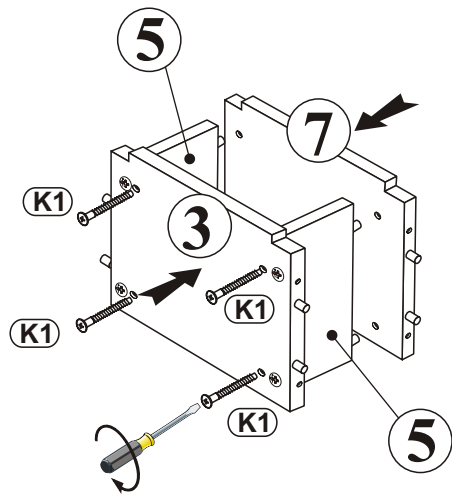
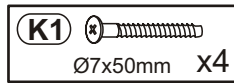

5

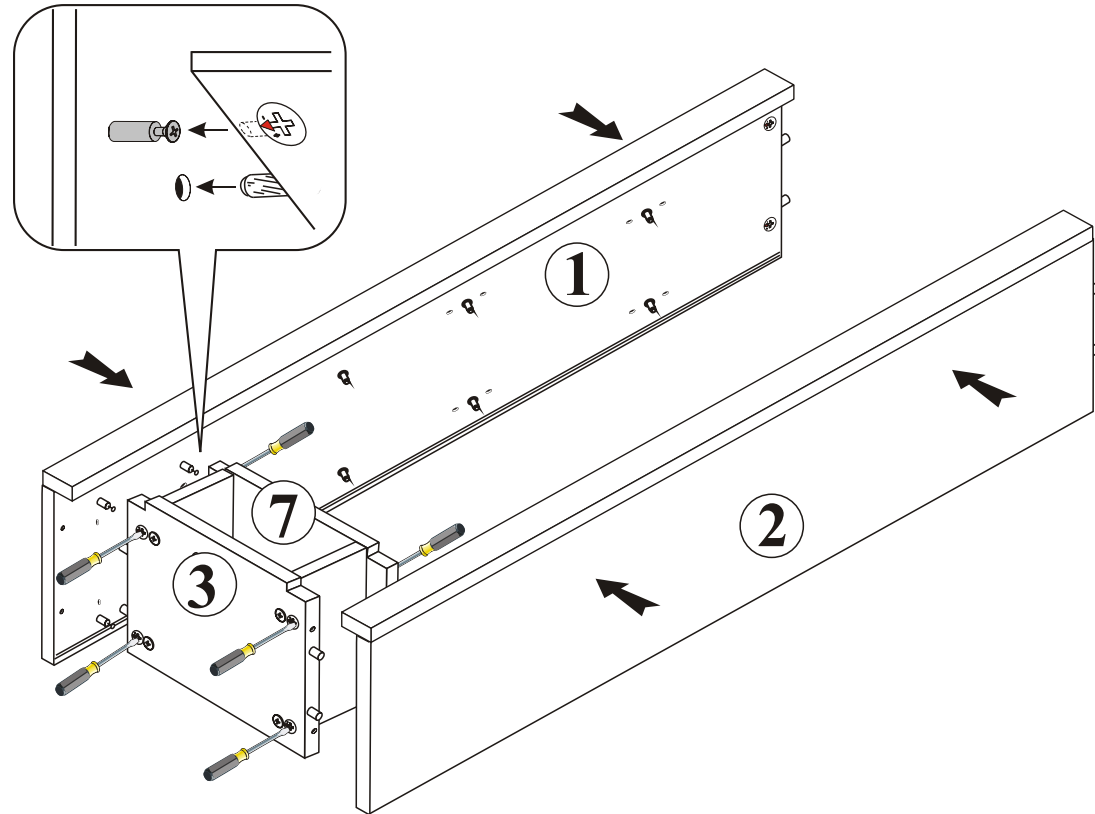

6

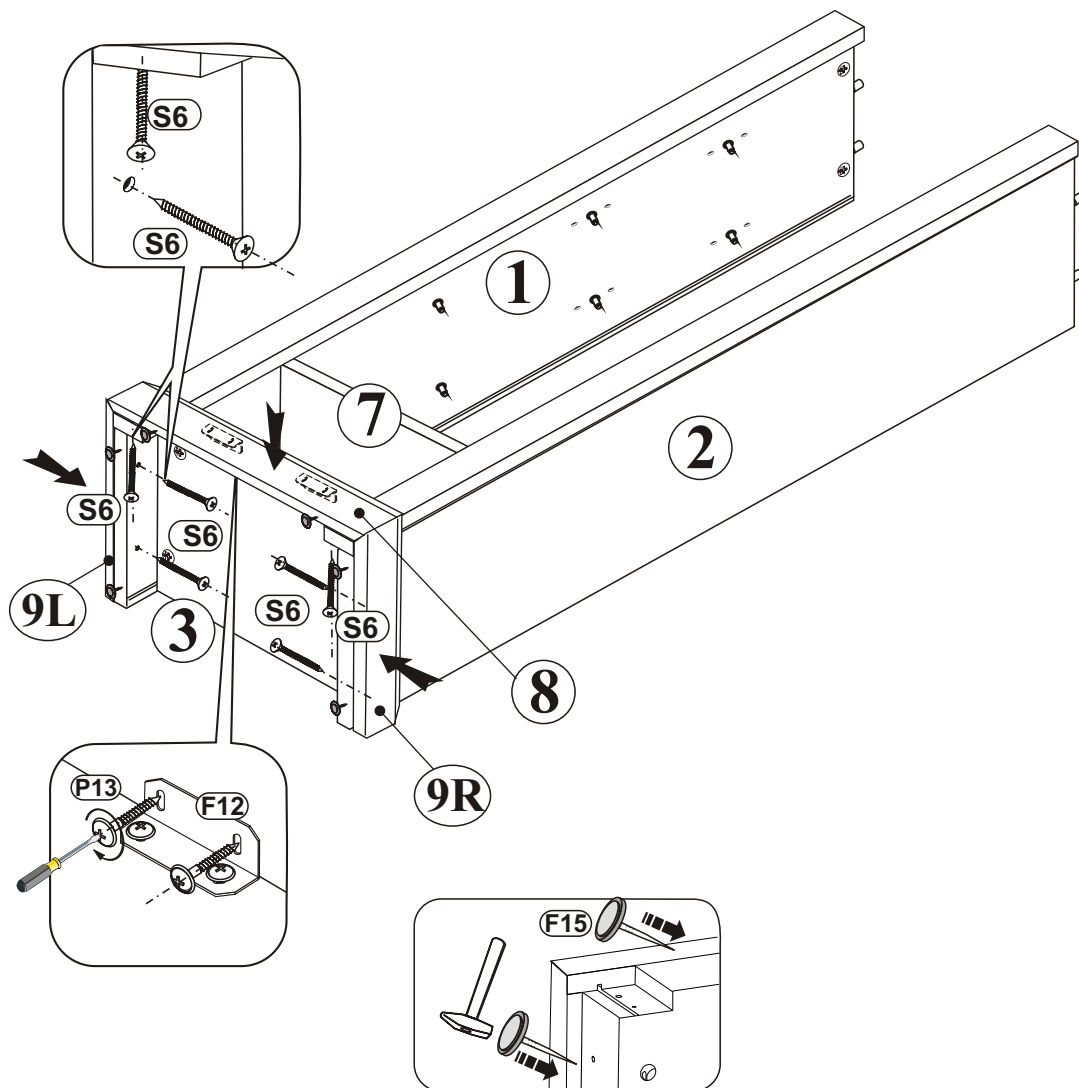
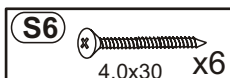
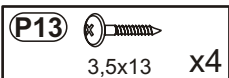
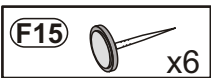

7

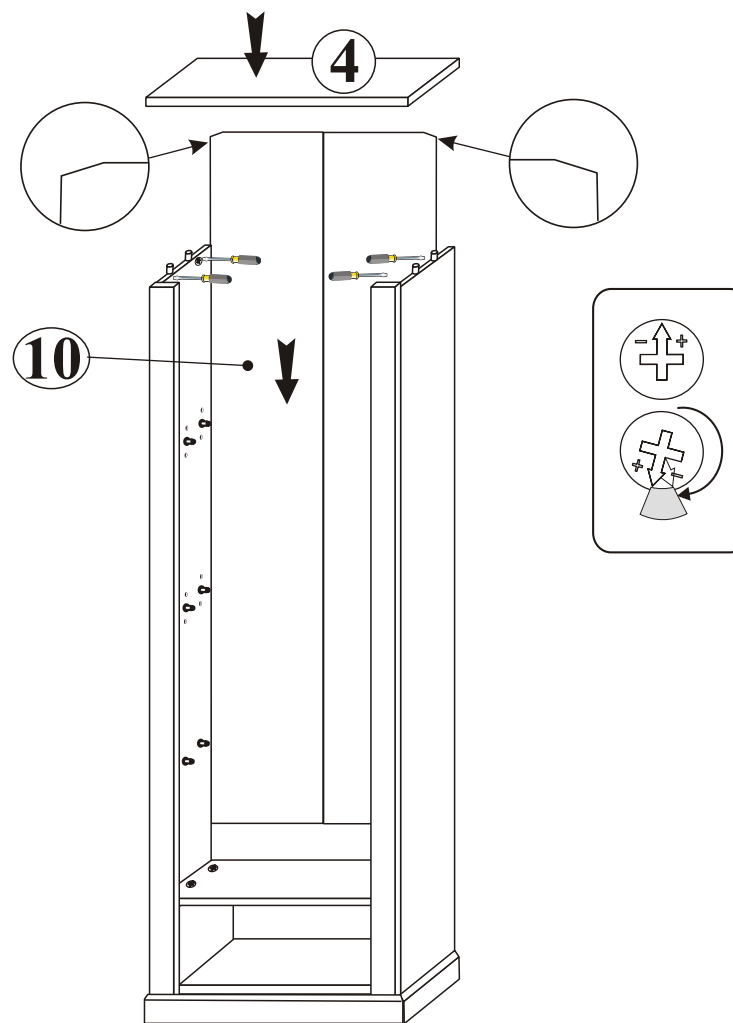

8

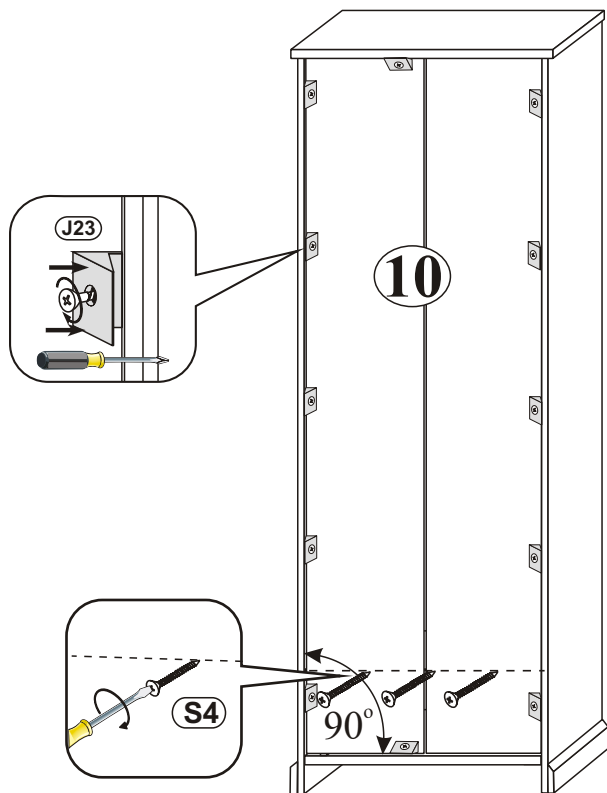
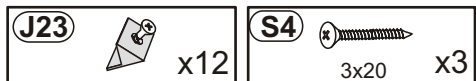

9

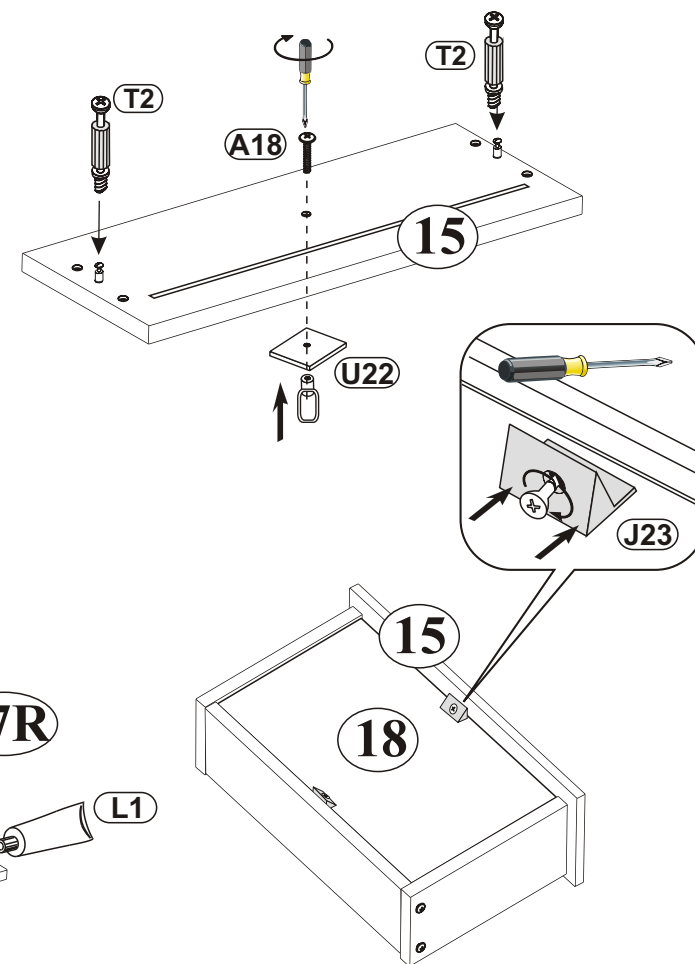
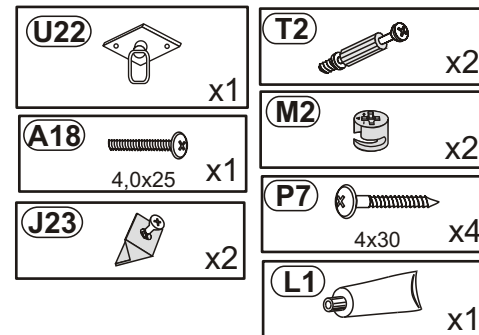
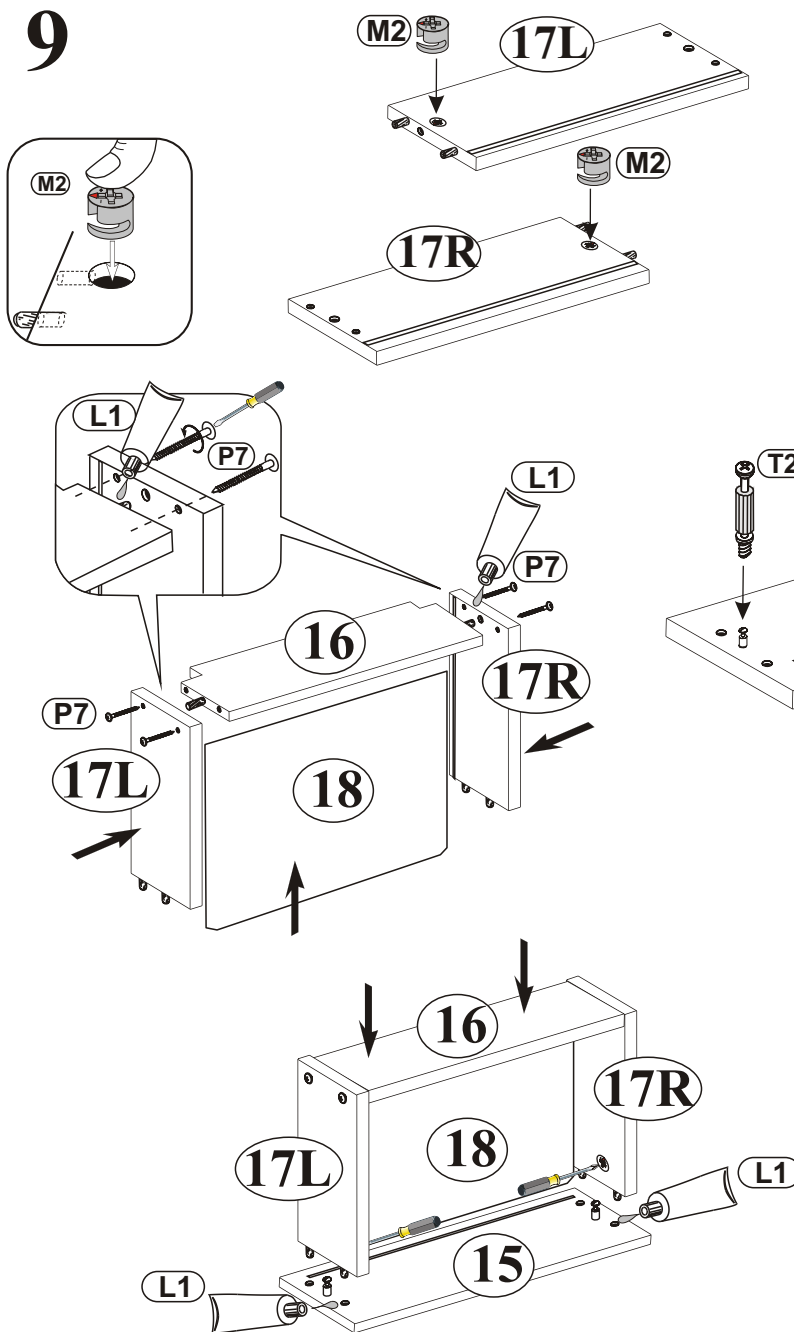

10

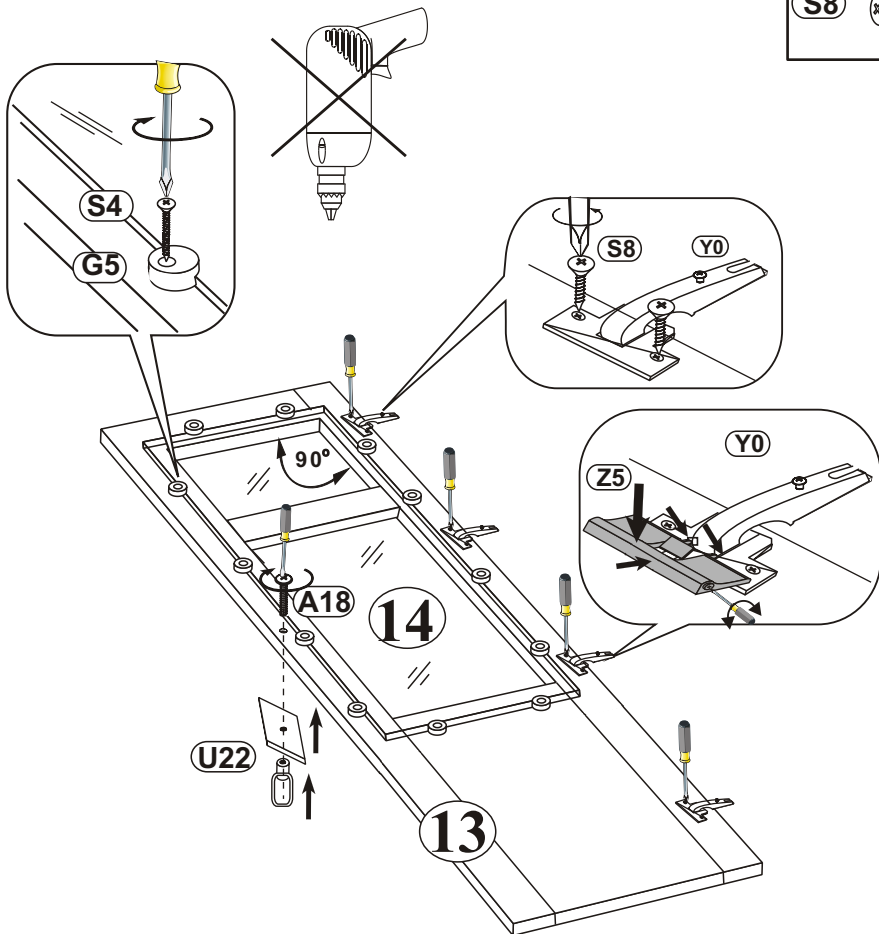
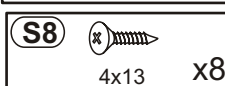
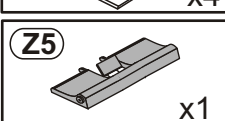
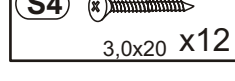
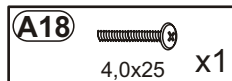
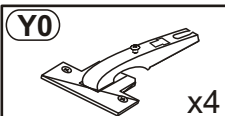
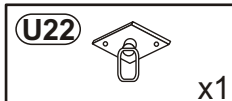

11

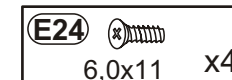
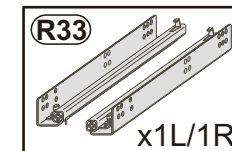
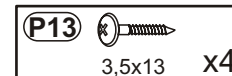
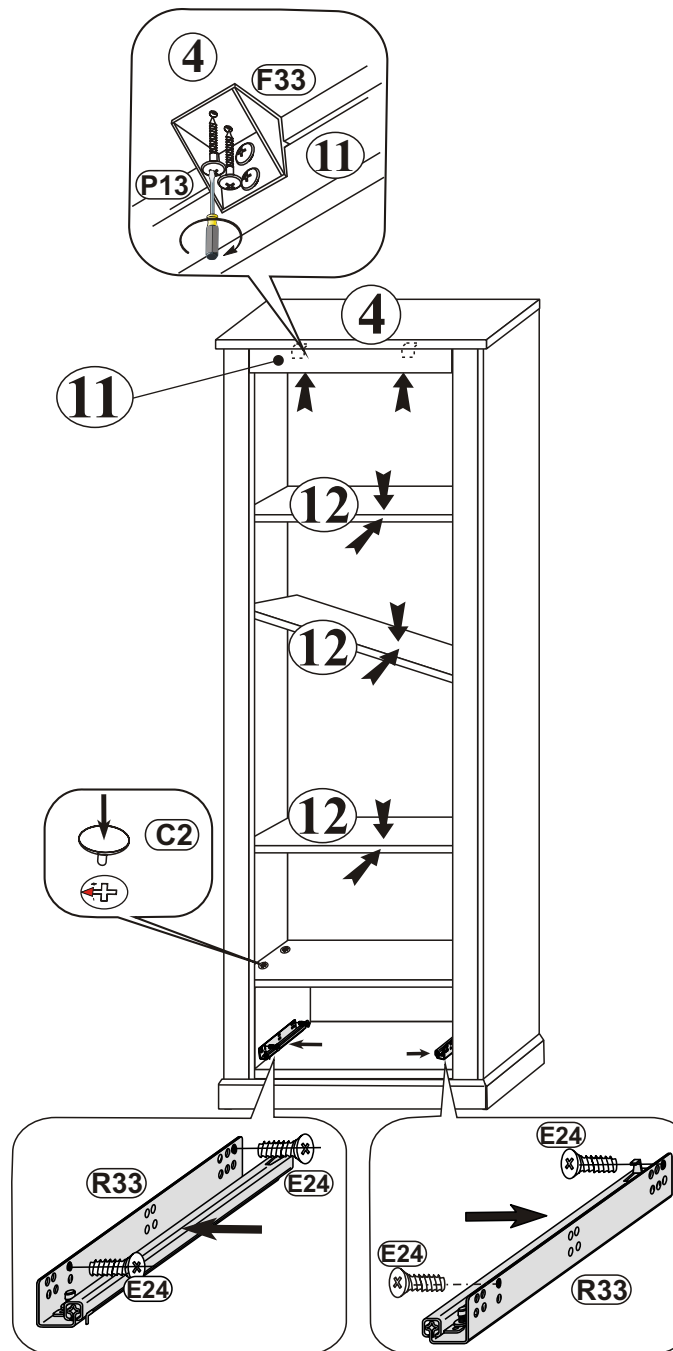

12

