





1

T6  x24

M1  x8

T1  x8

B1  ϕ 8x28 x16

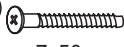
K1  7x50 x8

C1  ϕ 2 x8

P16  4,2x13 x12

M6  x12

C2  x8

W1  32

2

F7  x4

S3  3,0x13 x4

3

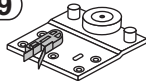
E9  x2

E1  6,3x11 x10

E11  x2

4

E5  x2

E1  6,3x11 x10

5

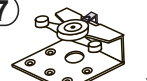
E7  x2

E1  6,3x11 x10

E12  x2

S10  3,5x25 x4

6

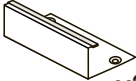
E3  x2

E1  6,3x11 x4

7

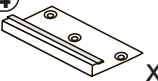
E4  x4

E1  6,3x11 x8

8

L1  x1

S4  3,5x13 x9

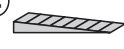
L4  x2

L5  L=2150 mm x4

S5  3,0x13 x60

9

J11  x2

P13  3,5x13 mm x4

10

S8  3,0x20 x2

S9  x1

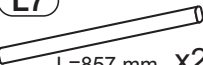
L7  L=857 mm x2



1

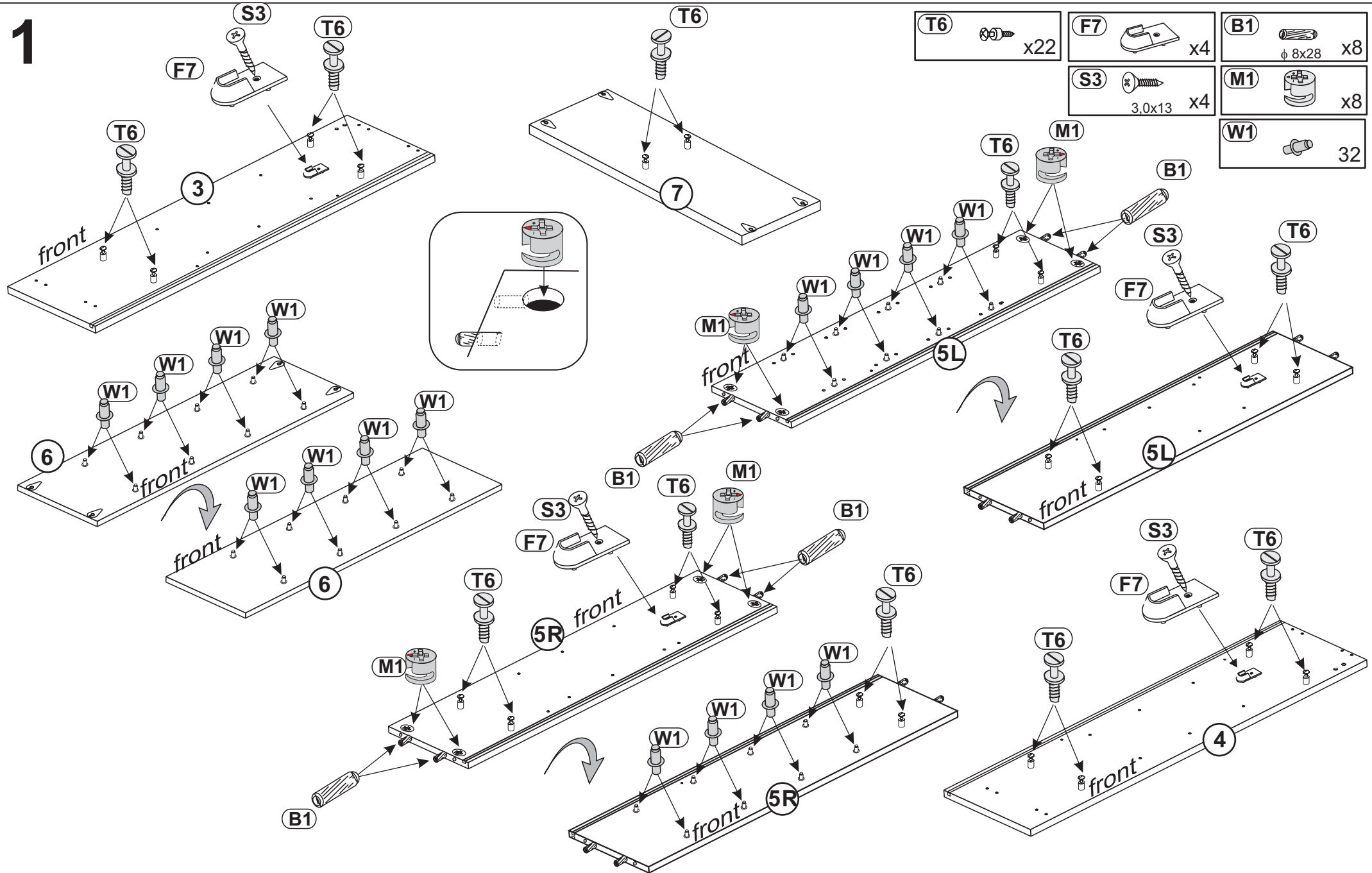

2

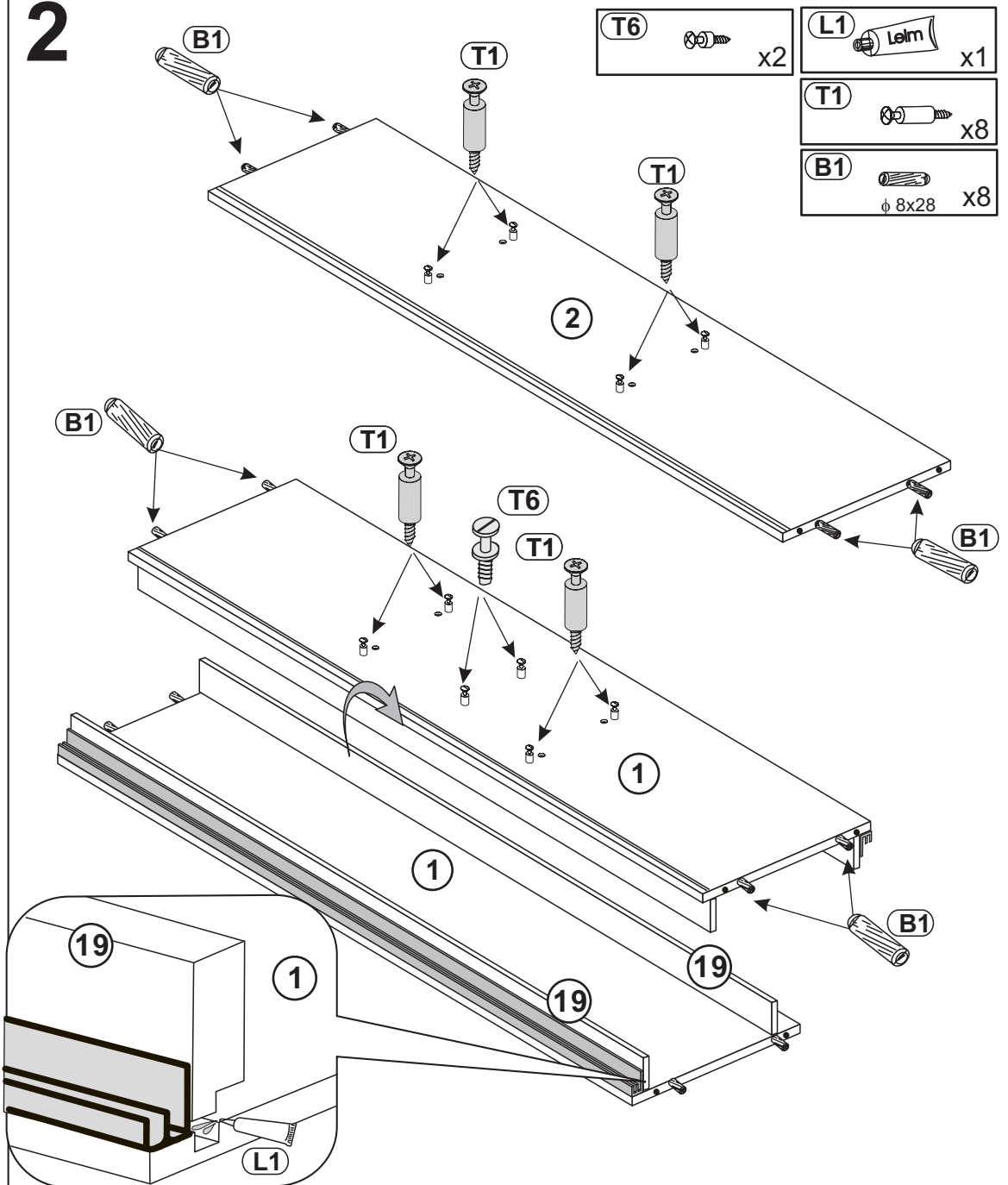

3

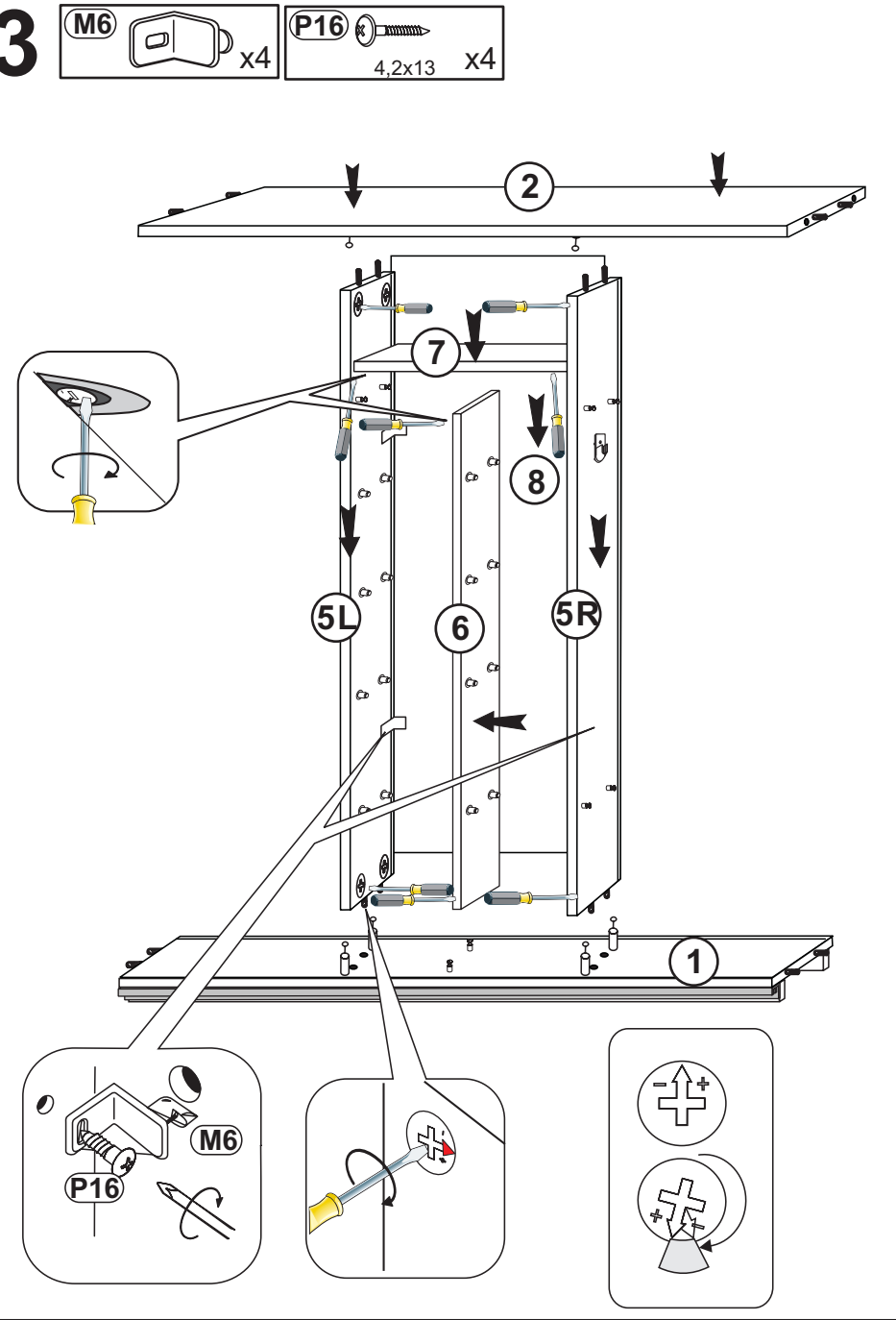

4

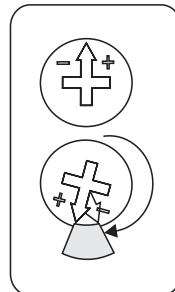
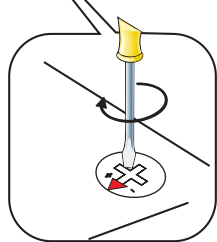
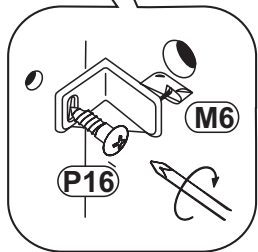
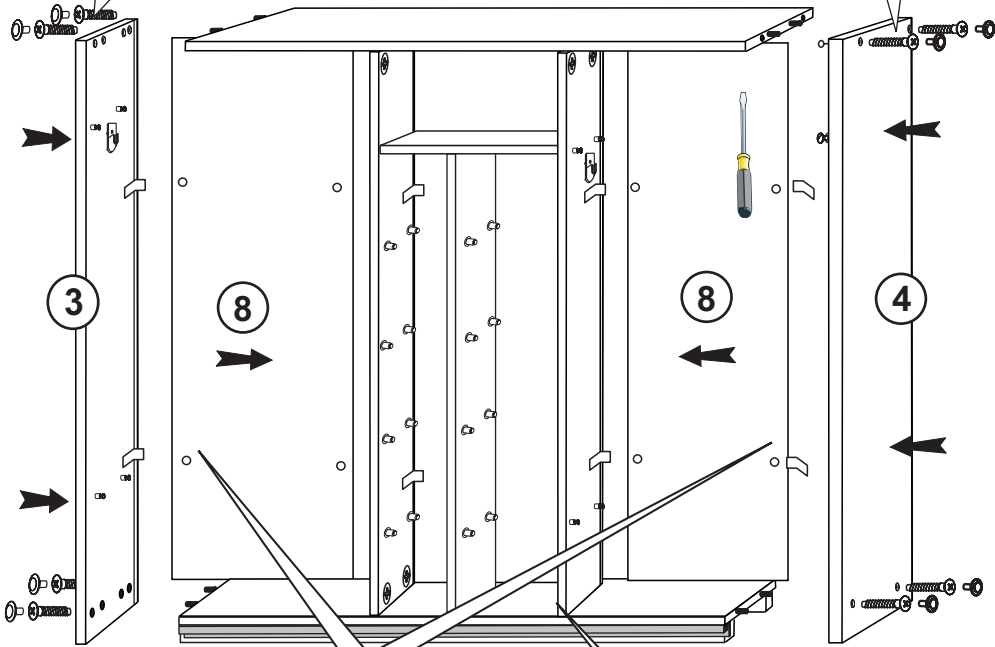
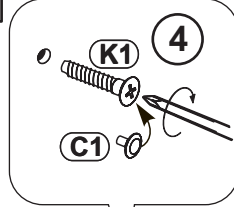
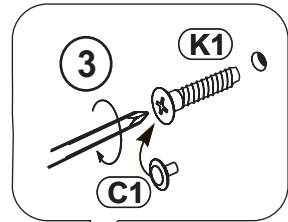
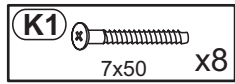

5

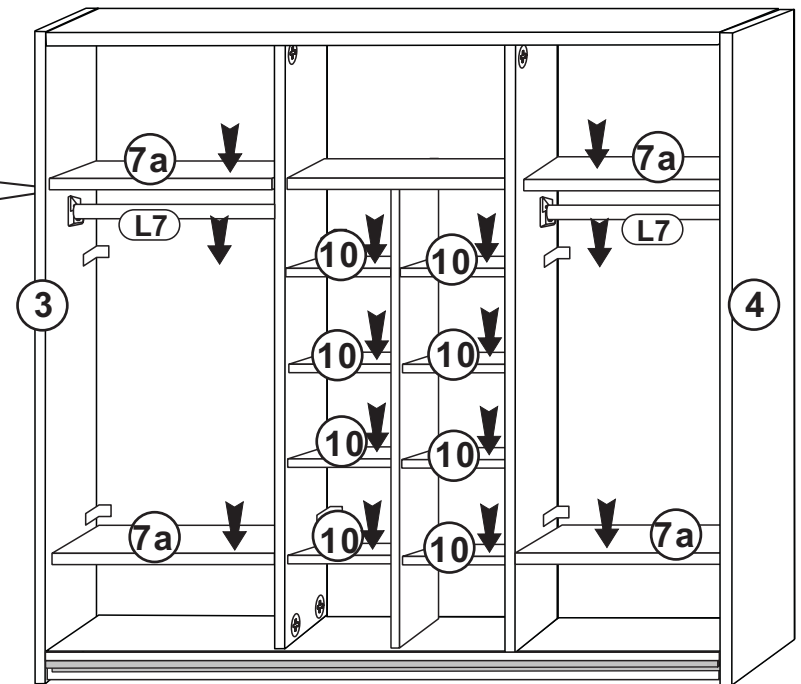
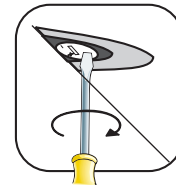
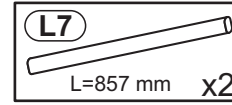

6

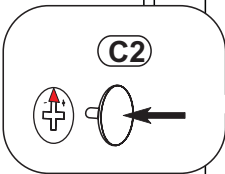
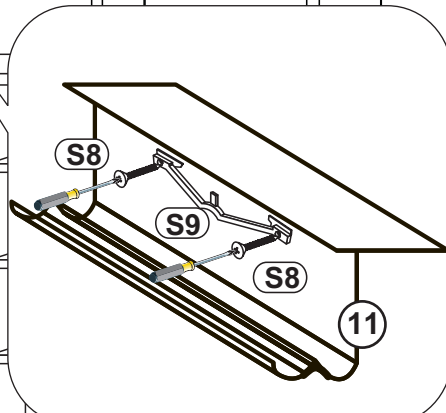
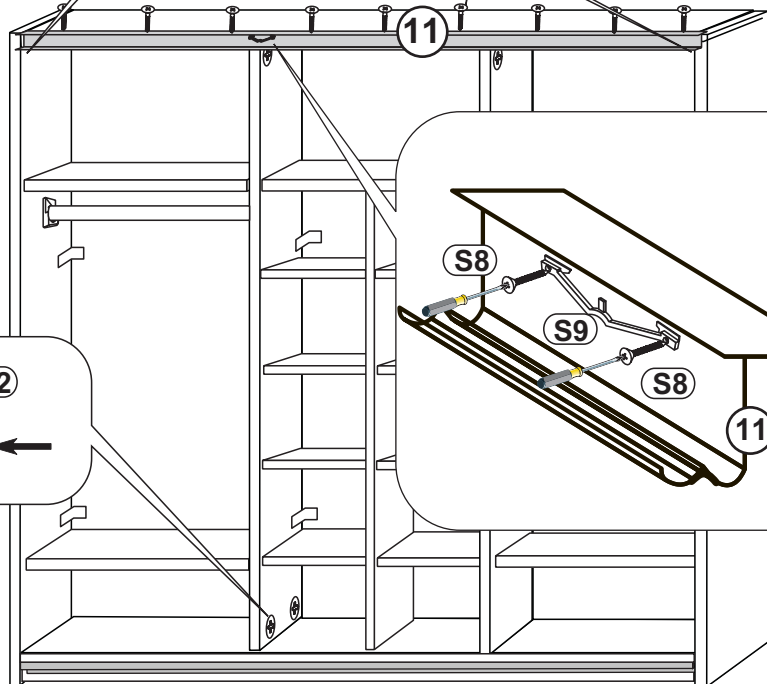
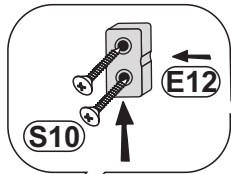
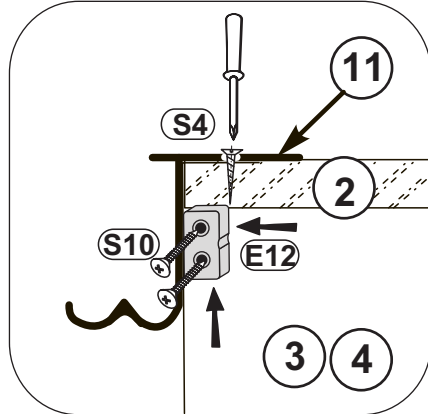
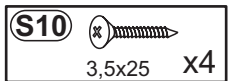
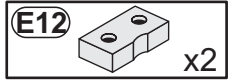
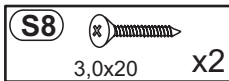
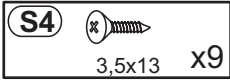

7

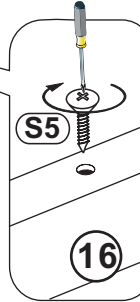
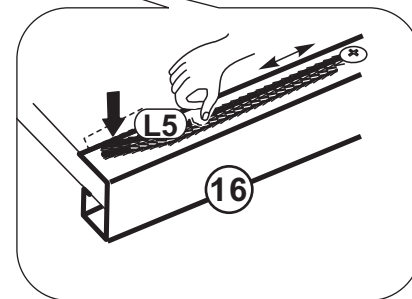
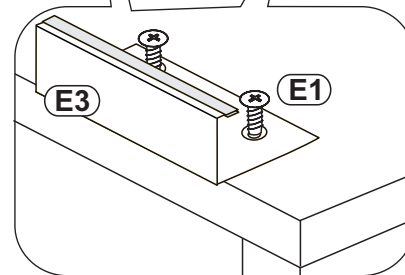
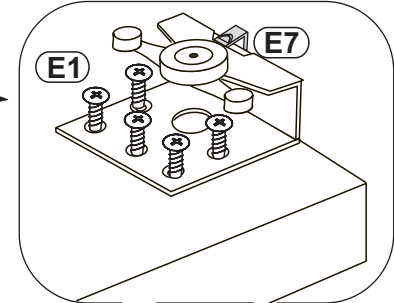
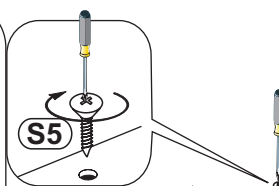
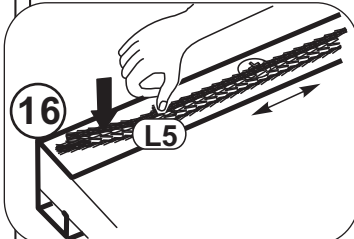
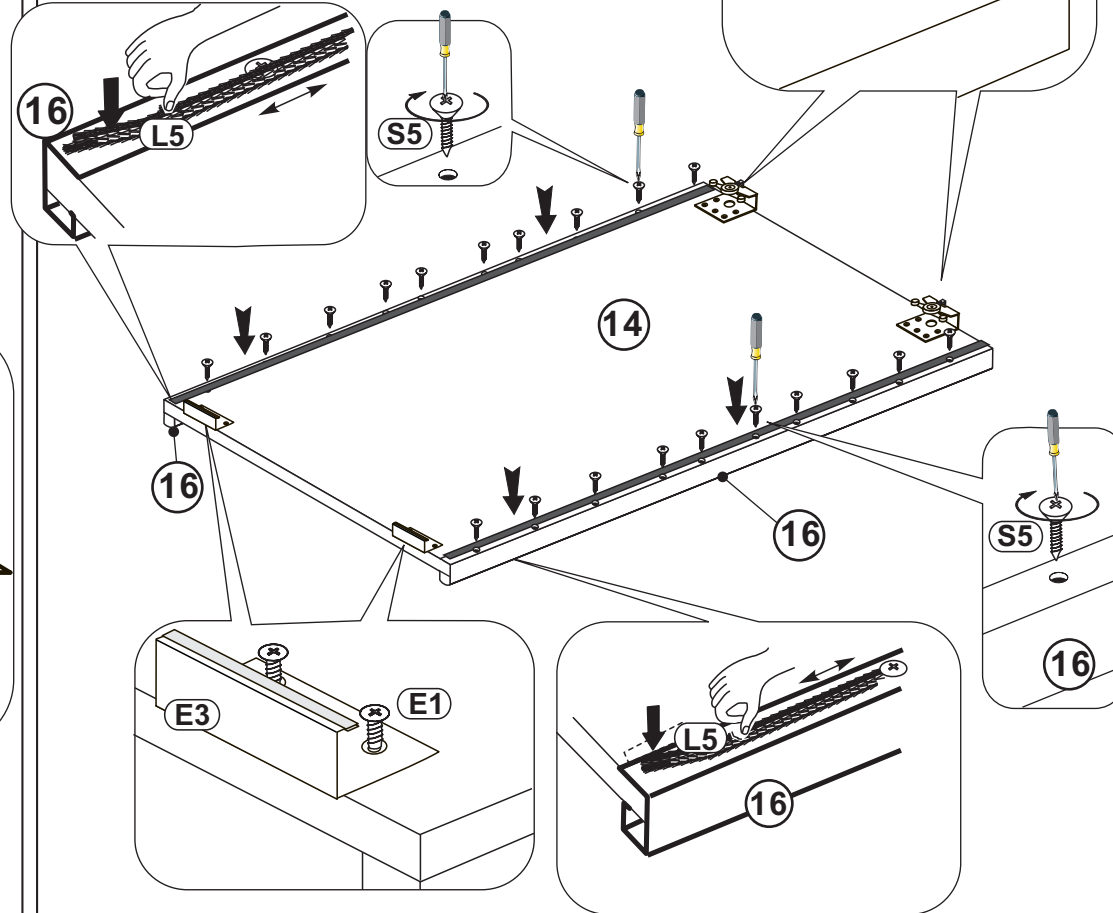
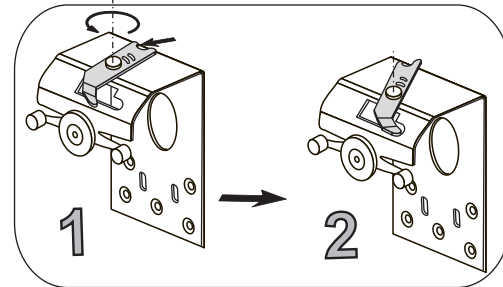
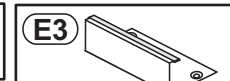
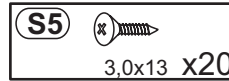

8

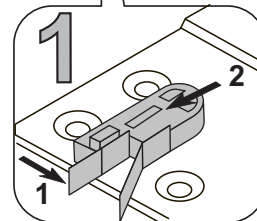
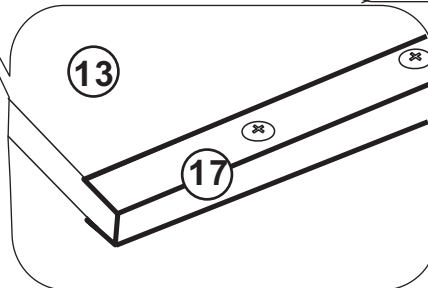
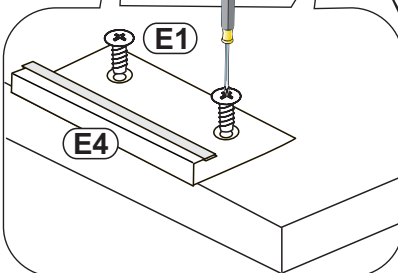
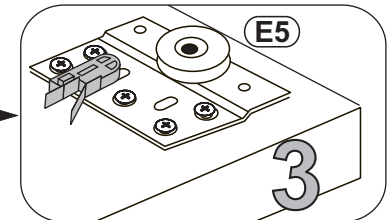
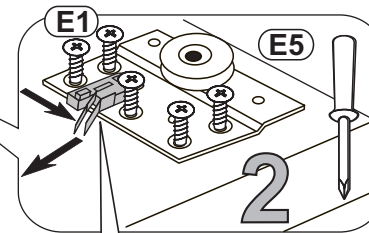
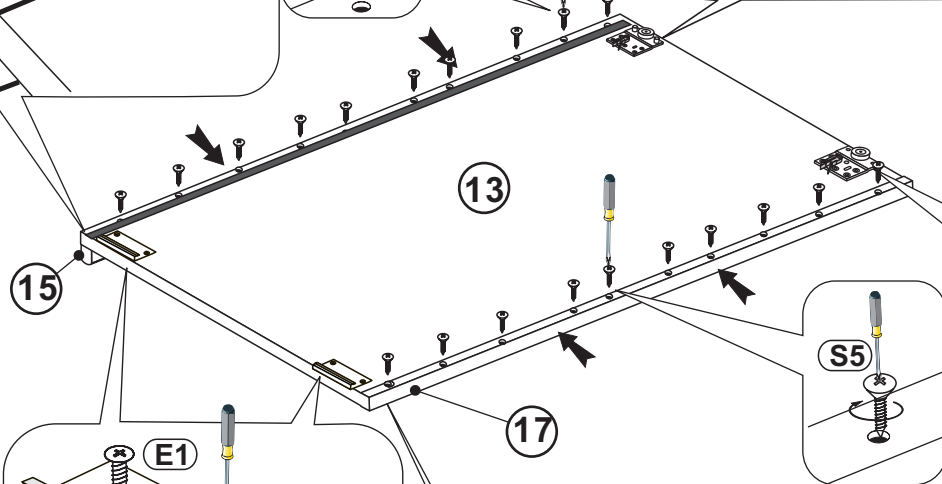
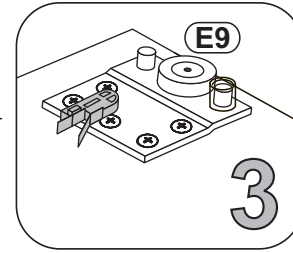
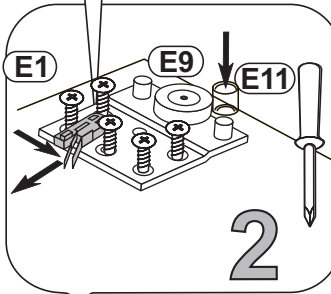
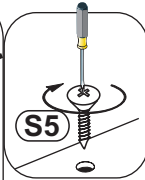
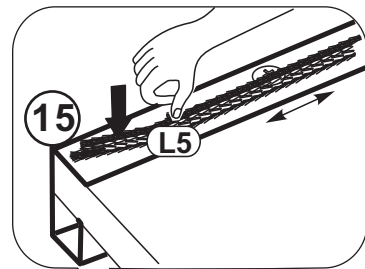
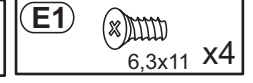
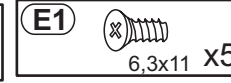
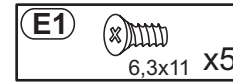
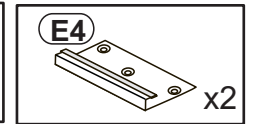
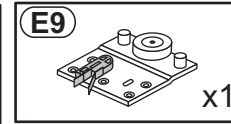
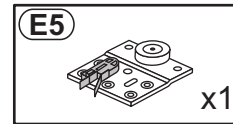
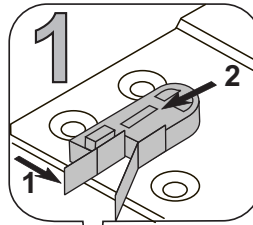
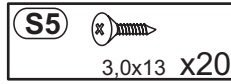

9

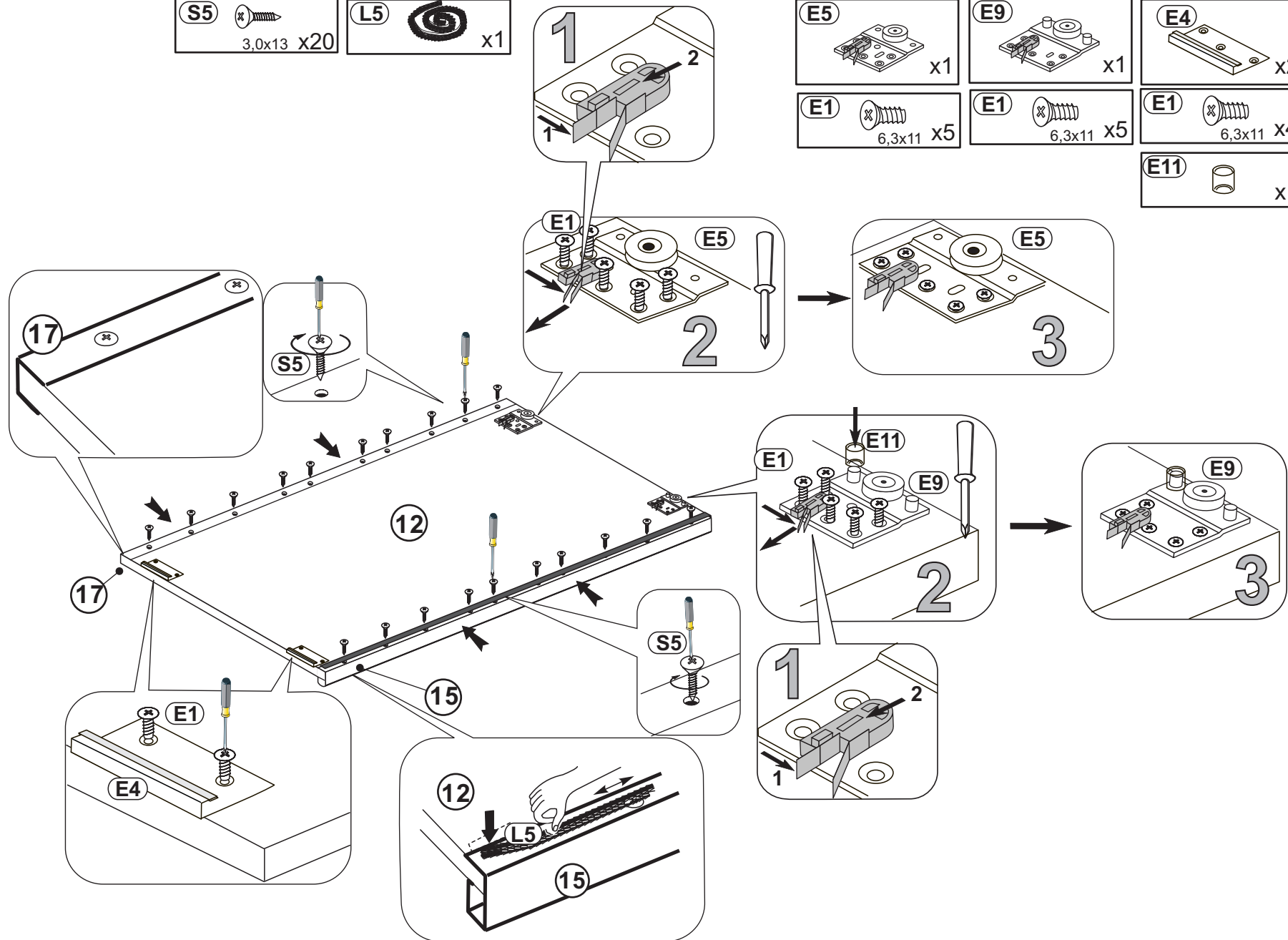
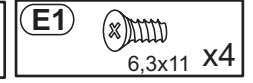
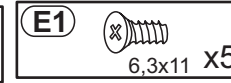
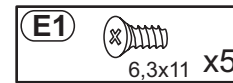
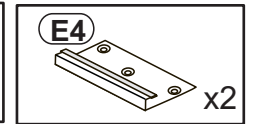
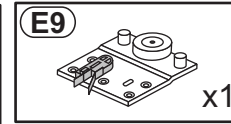
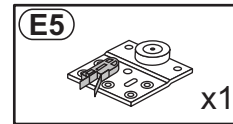
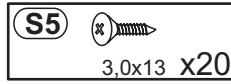

10

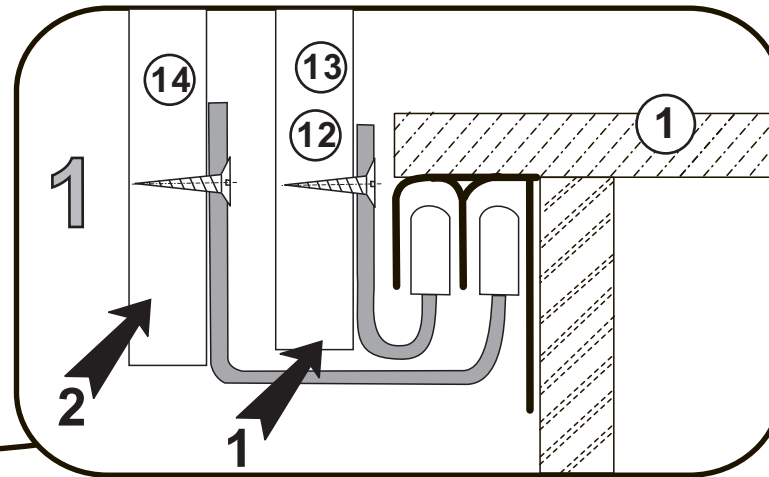
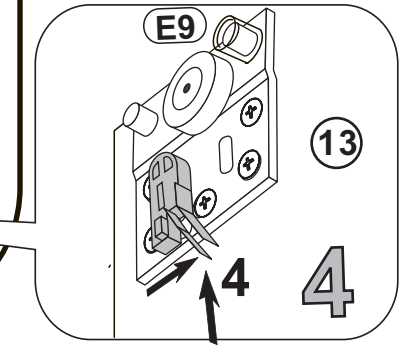
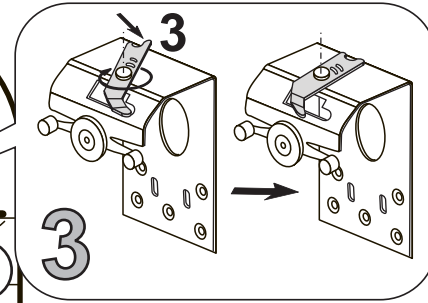
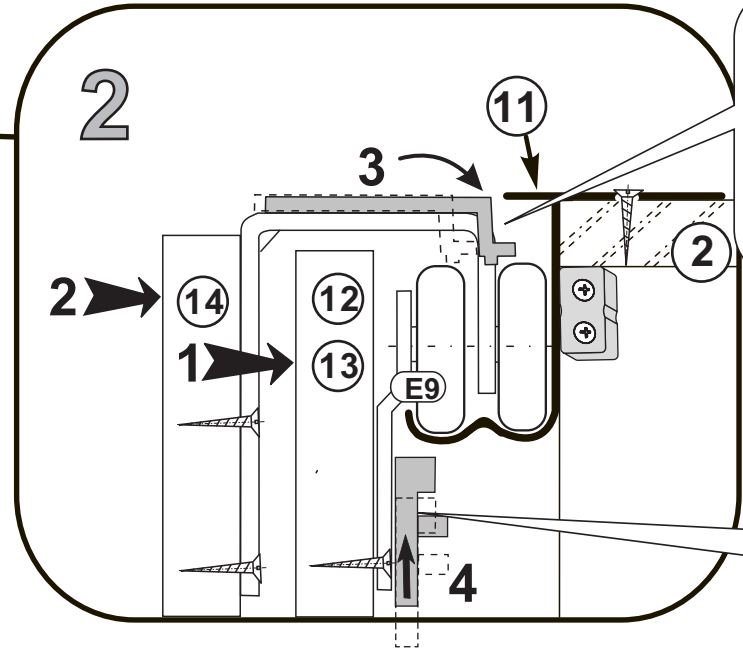

11

