

**PLAN DE MONTAGE**

**FORMAT A4  
POUR PERENCHIES**

**INSCRIPTION SUR BOITE  
POUR LOMPRET**



# Demeyere

SAV  
SPAREPARTS  
KUNDEDIENST  
POST VENTAS  
SERVICE NA VERKOOP  
SERVIZIO POST-VENDITA  
SERVICO DEPOIS DE VENDA  
SERWIS POGWARANCYJNY

## 7982 2

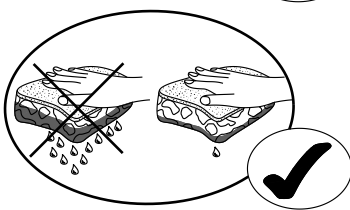
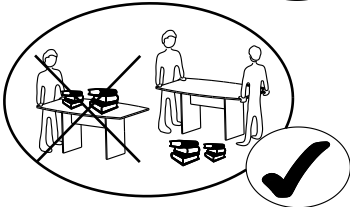
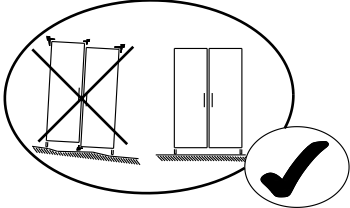
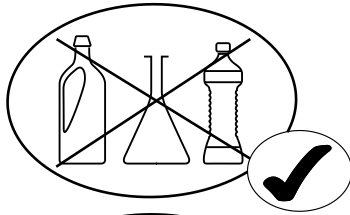

REP	DIM	QTE
1	703 x 293	1
2	703 x 293	1
3	577 x 292	1
4	577 x 59	1
5	589 x 155	4
6	250 x 569	4
7	554 x 248	4
8	605 x 266	1

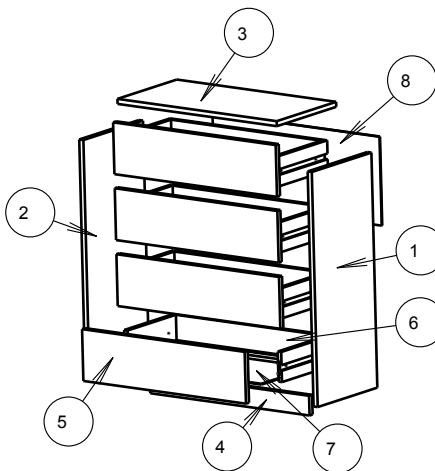
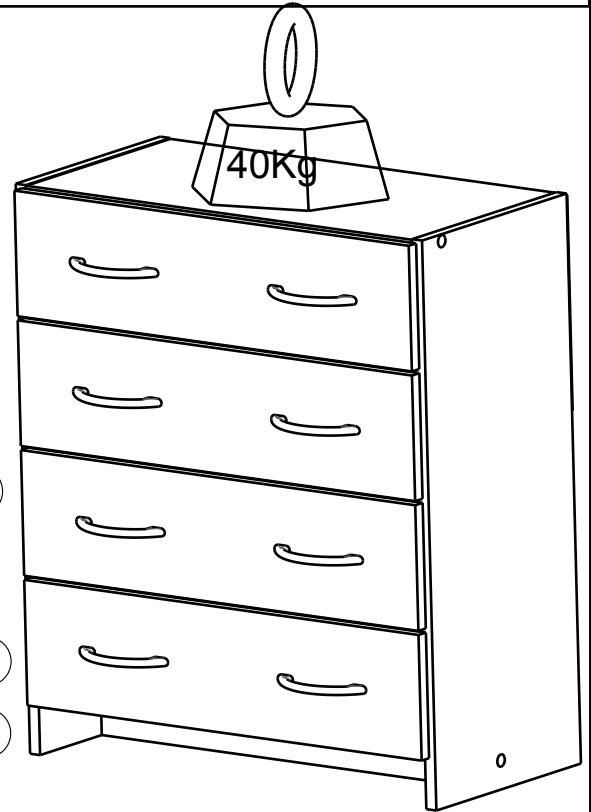

340750 X 4 	728 X 2 	340132 X 1 	434 X 1 	7961 X 4 
935 X 16 	1629 X 8 	1109 X 4 	604757 X 1 	
		918 X 16 	332169 X 8 	



1H 00MN



**FR** SECURITE

RESPECTER LES INSTRUCTIONS DE MONTAGE DECRITES DANS LA NOTICE.

**EN** CAUTION

FOLLOW CAREFULLY THE ASSEMBLING INSTRUCTIONS DESCRIBED IN THE DIRECTIONS.

**DE** SICHERHEITSVORSCHRIFTEN

BEACHTEN SIE BITTE UNBEDINGT DIE ANGEGEBENEN AUFBAUVORSCHRIFTEN.

**ES** SEGURIDAD

RESPECTAR LAS INSTRUCCIONES DE MONTAJE DESCRIBIDAS EN EL FOLLETO.

**NL** VEILIGHEID

DE IN DE GEBRUIKSAANWIJZING BESCHREVEN INSTRUCTIES RESPECTEREN.

**IT** SICUREZZA

RISPETTARE LE INSTRUZIONI DI MONTAGGIO DESCRITTE NEEL'AVVERTENZA.

**PT** SEGURANCA

RESPEITAR AS INSTURAOÇOS DE MONTAGEM DESCREVEDAS NA INSTRUÇOES DE USO.

**PL** UWAGA

PROSZĘ PRZESTRZEGAC INSTRUKCJI MONTAZU.

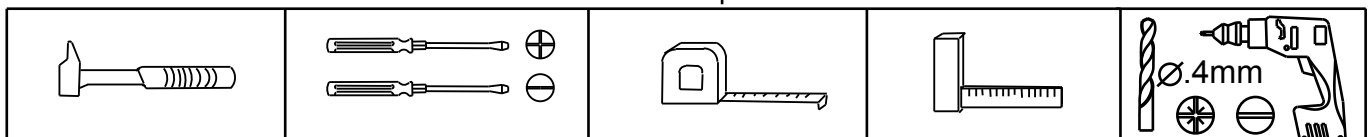

FABRICATION FRANCAISE

**1**

935 X16	7961 X 4
---------	----------

VBA SPAX TF 3x12

**2**

728 X 2
---------

5x30

**3**

340750 X 4	434 X 1
------------	---------

6 PANS 7x50

**4**

604757 X1
-----------

x30

**5**

332169 X8	918 X16	340132 X 1
-----------	---------	------------

VBA TR 4x25

GLUE

**x4**

2H

Ø4mm

**6**

1629 X 8	1109 X 4
----------	----------