

MEUBLES
DEMEYERE

SAV
SPAREPARTS
KUNDERDIENST
POST VENTAS
SERVICE NA VERKOOP
SERVIZIO POST-VENDITA
SERVICO DEPOIS DE VENDA
SERWIS POGWARANCYJNY

3238 1

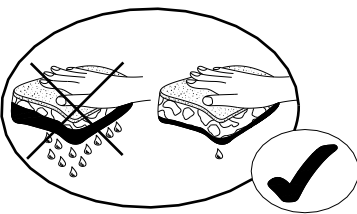
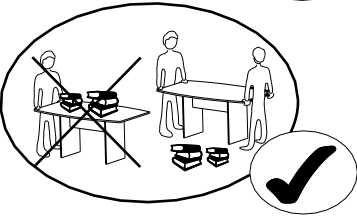
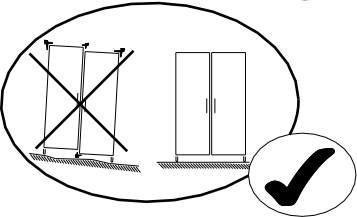
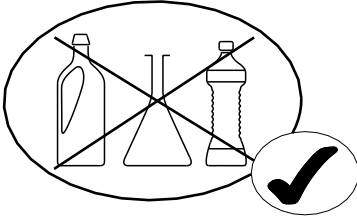
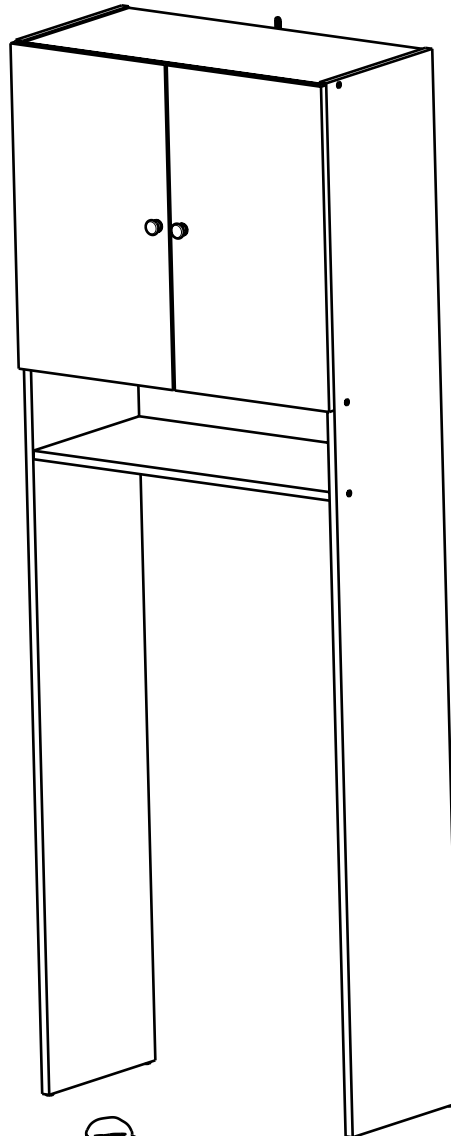

1H 00M N

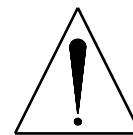
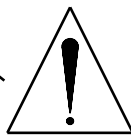

FR SECURITE

RESPECTER LES INSTRUCTIONS DE MONTAGE DECRITES DANS LA NOTICE.

EN CAUTION

FOLLOW CAREFULLY THE ASSEMBLING INSTRUCTIONS DESCRIBED IN THE DIRECTIONS.

DE SICHERHEITSVORSCHRIFTEN

BEACHTEN SIE BITTE UNBEDINGT DIE ANGEgebenEN AUFBAUVORSCHRIFTEN.

ES SEGURIDAD

RESPECTAR LAS INSTRUCCIONES DE MONTAJE DESCRIBIDAS EN EL FOLLETO.

NL VEILIGHEID

DE IN DE GEBRUIKSAANWIJZING BESCHREVEN INSTRUCTIES RESPECTEREN.

IT SICUREZZA

RISPETTARE LE ISTRUZIONI DI MONTAGGIO DESCRITTE NEEL'AVVERTENZA.

PT SEGURANCA

RESPEITAR AS INSTRUCOES DE MONTAGEM DESCRITAS NA INSTRUCCOES DE USO.

PL UWAGA

PROSZE PRZESTRZEGAC INSTRUKCJI MONTAZU.

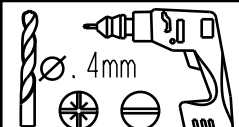
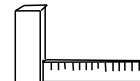
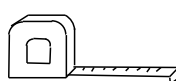
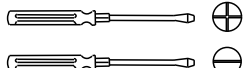
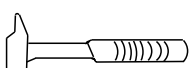

REP	DIM	QTE
1	1850 x 306	1
2	1850 x 306	1
3	630 x 305	3
4	630 x 303	1
5	571 x 328	2
6	570 x 328	2

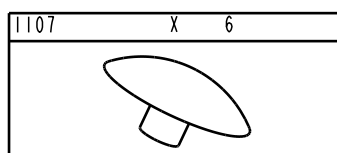
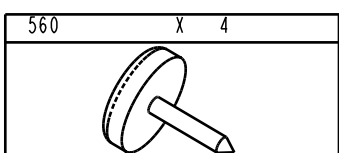
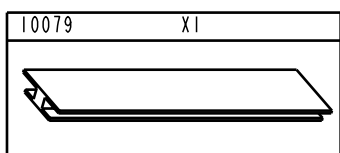
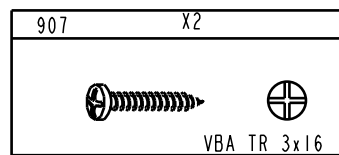
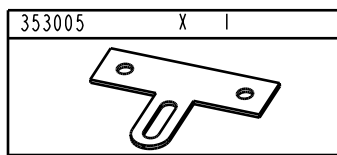
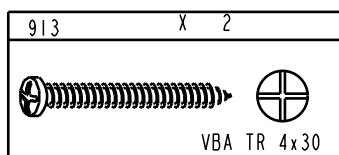
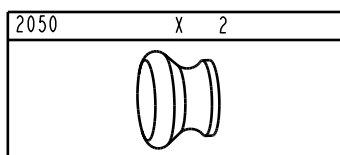
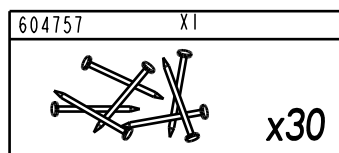
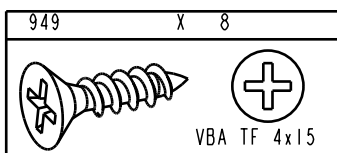
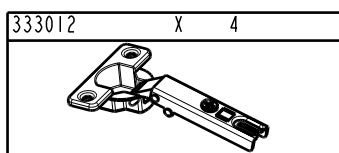
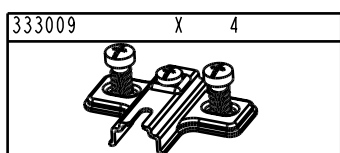
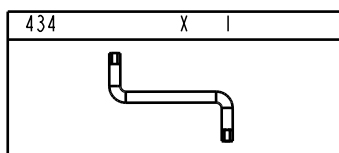
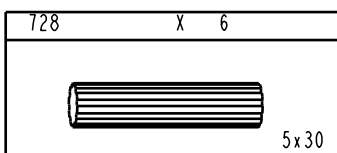
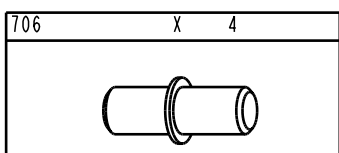
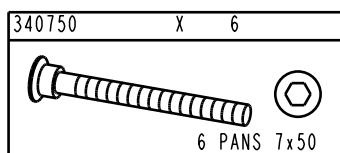
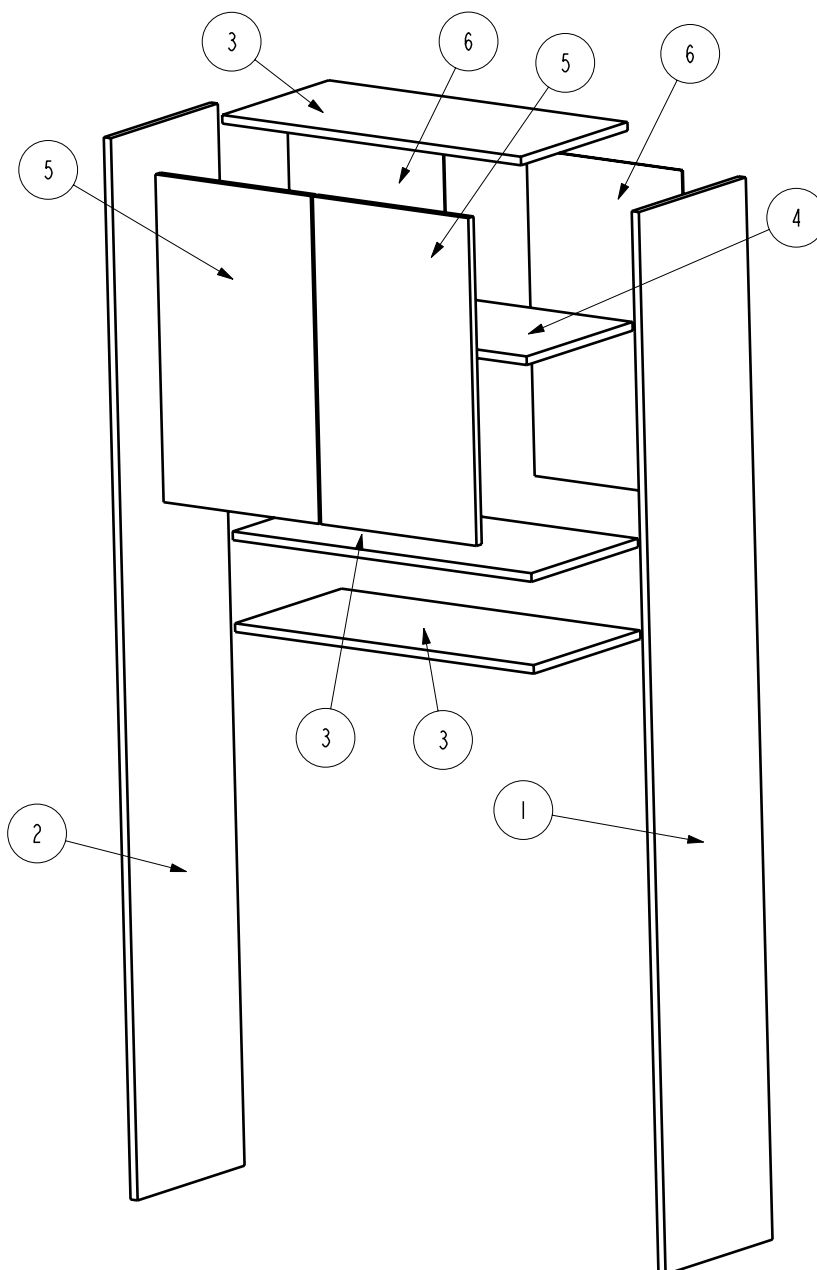

FR MEUBLES A FIXER AU MUR:
 - FIXER LE MEUBLE AU MUR AVEC LES ATTACHES PREVUES A CET EFFET
 - VERIFIER QUE LES VIS ET LES CHEVILLES UTILISEES SONT ADAPTEES AU SUPPORT

EN FURNITURES TO BE HOLD ON THE WALL:
 - HOLD THE FURNITURE ON THE WALL WITH THE FASTENINGS PROVIDED FOR THIS PURPOSE
 - CHECK THAT THE SCREW AND PEGS FIT WITH THE SUPPORT

DE MOEBEL AN DER MAUER ZU BEFESTIGEN:
 - BEFESTIGEN SIE DAS MOEBELSTUECK MIT DEN DAFUER VORGESEHENEN BEFESTIGUNGSHAKEN
 - UEBERPRUEFEN SIE BITTE DASS DIE SCHRAUBEN UND DUEBEL MIT DEM MATERIAL DER MAUER UEBEREINSTIMMEN

ES MUEBLES A FIJAR EN LA PARED:
 - FIJAR EL MUEBLE EN LA PARED CON LAS GRAPAS PREVISTAS
 - COMPROBAR QUE LOS TORNILLOS Y LAS CLAVIJAS UTILIZADAS SON ADAPTADAS AL SOPORTE

IT MOBILI DA FISSARE AL MURO:
 - FISSARE IL MOBILE AL MURO CON LE FLANGIE PREVISTE A TALE SCOPO
 - VERIFICARE CHE LE VITI ED I PERNI USATI SIANO ADATTI A QUEL TIPO DI SUPPORTO

NL MEUBELS DIE AAN DE MUUR GEFIXEERD MOETEN WORDEN:
 - FIXEER HET MEUBEL AAN DE MUUR MET DE DAARVOOR BESTEMDE HAKEN
 - VERFIEER OF DE GEBRUIKTE SCHROEVEN BIJ DE BEVESTIGINGSHAAK HOREN

PT MOVEIS A FIXAR NA PAREDE:
 - FIXAR O MOVEL NA PAREDE COM OS PRENDES PREVISTOS
 - VERIFICAR QUE OS PARAFUSOS E AS CAVILHAS UTILIZADOS SAO ADAPTADOS OA SUPORTE

PL MEBEL PRZEZNACZONY DO ZAINSTALOWANIA NA ŚCIANE:
 - NALEŻY ZAMONTOWAC TEN MEBEL NA ŚCIANIE PRZEZNACZONYMI DO TEGO CELU UCHWYTAMI
 - NALEŻY SPRAWDZIC CZY SRUBY I KOSZULKI SA ODPOWIEDNIEJ WIELKOŚCI W STOSUNKU DO UCHWYTÓW

1

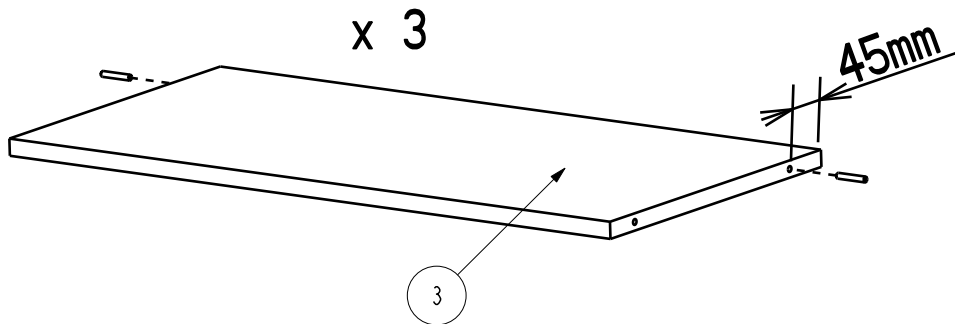
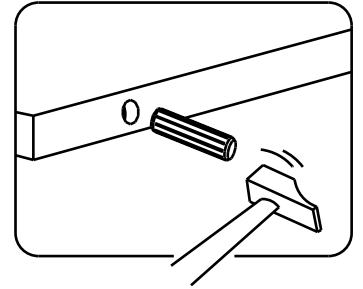
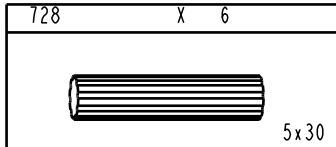

2

333012 X 4	949 X 8	2050 X 2	913 X 2
	 VBA TF 4x15		 VBA TR 4x30

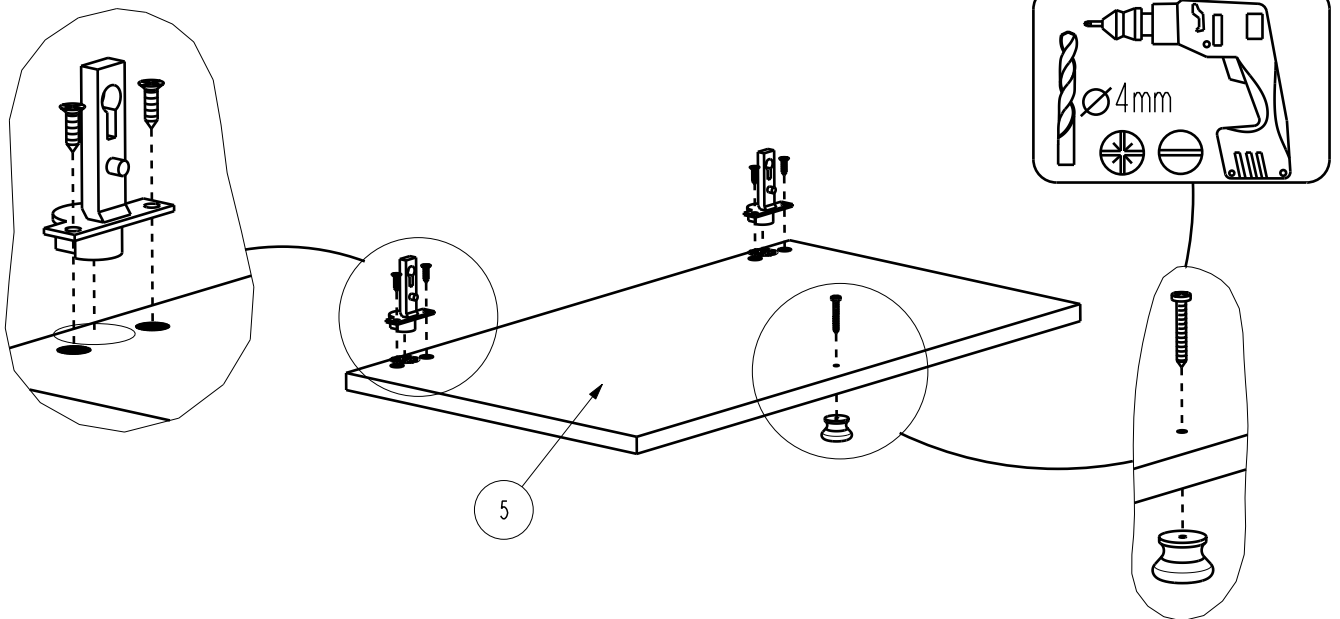

3

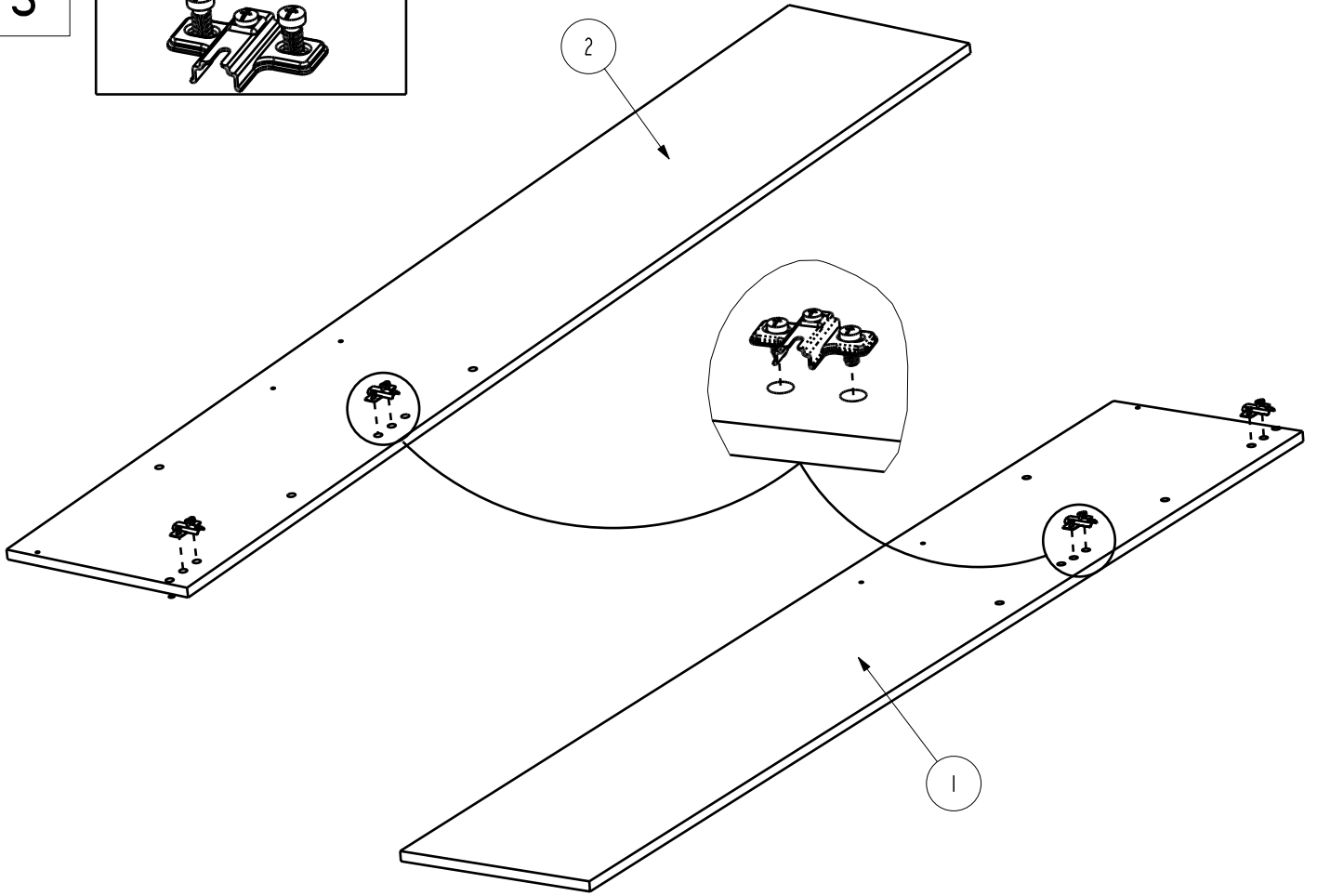
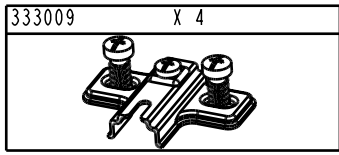

4

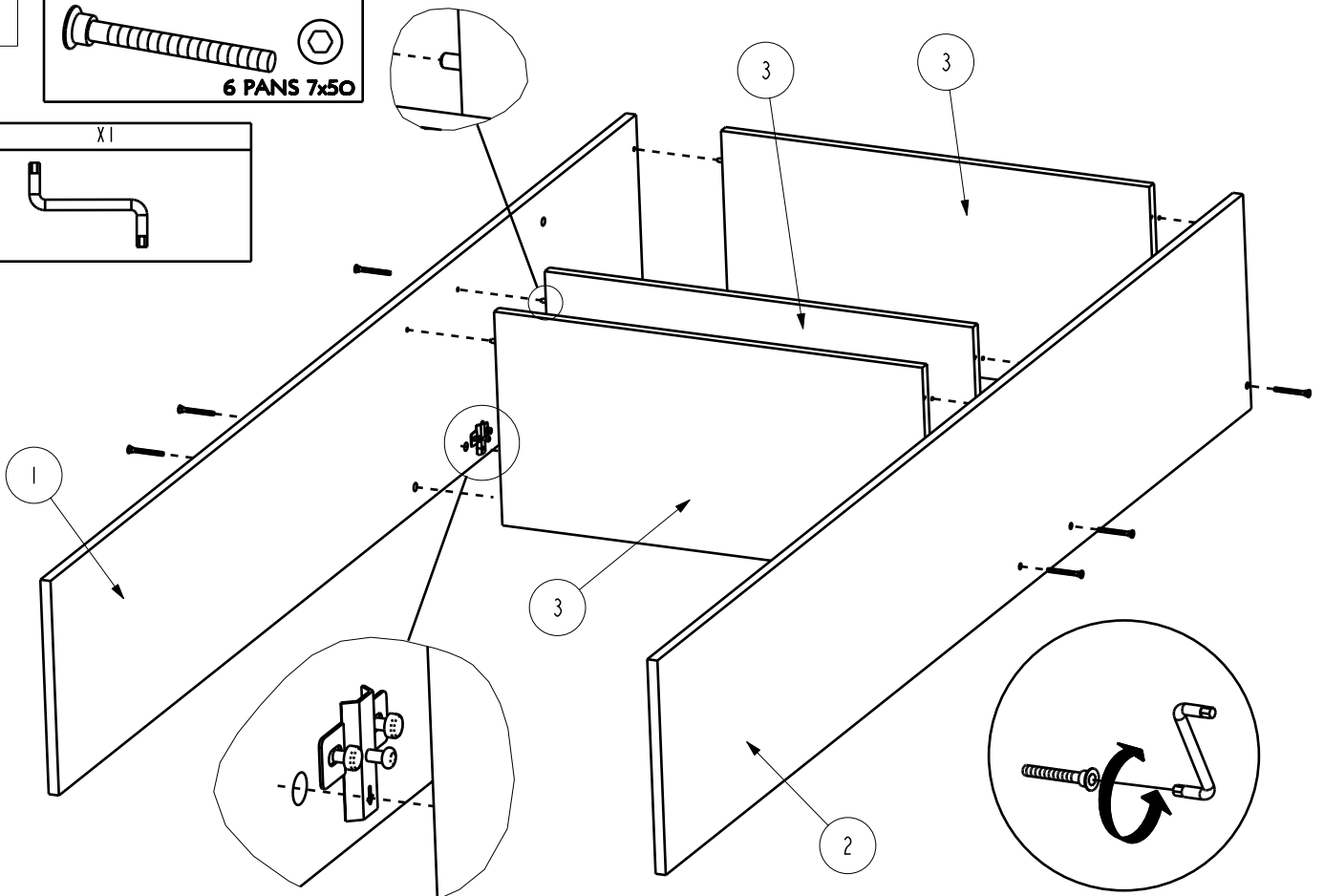
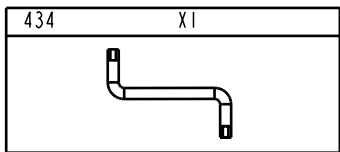
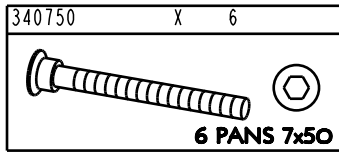

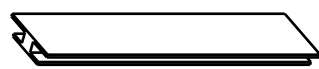

5

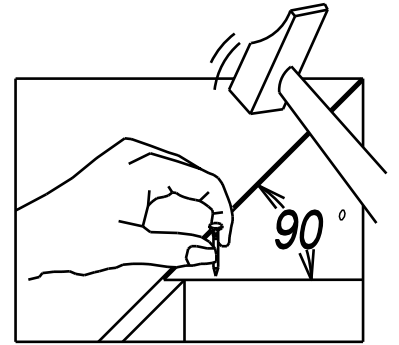
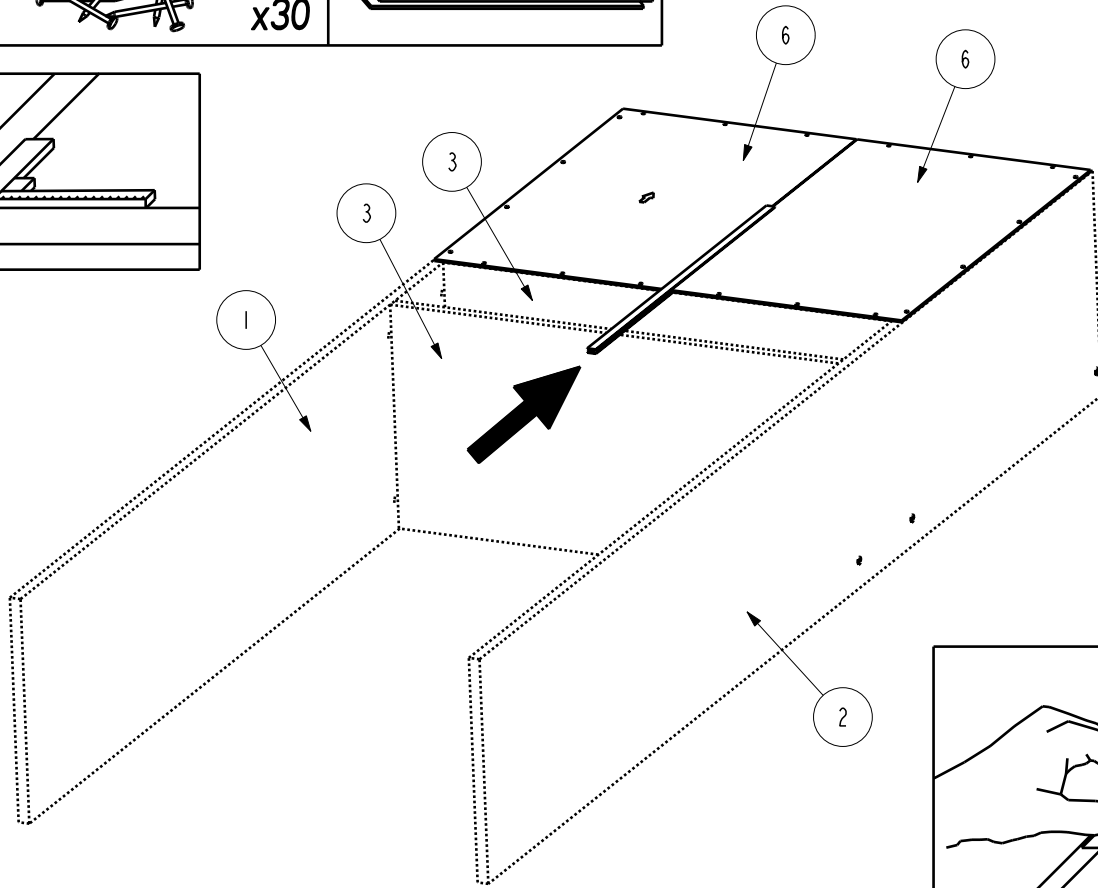
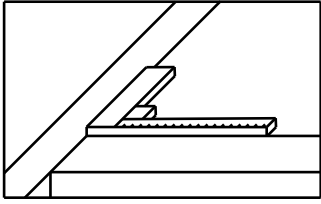
604757	X 1	10079	X 1
	x30		

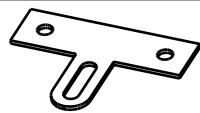

6

560	X 4	353005	X 1	907	X 2
					 VBA TR 3x16

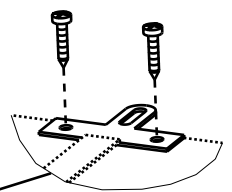
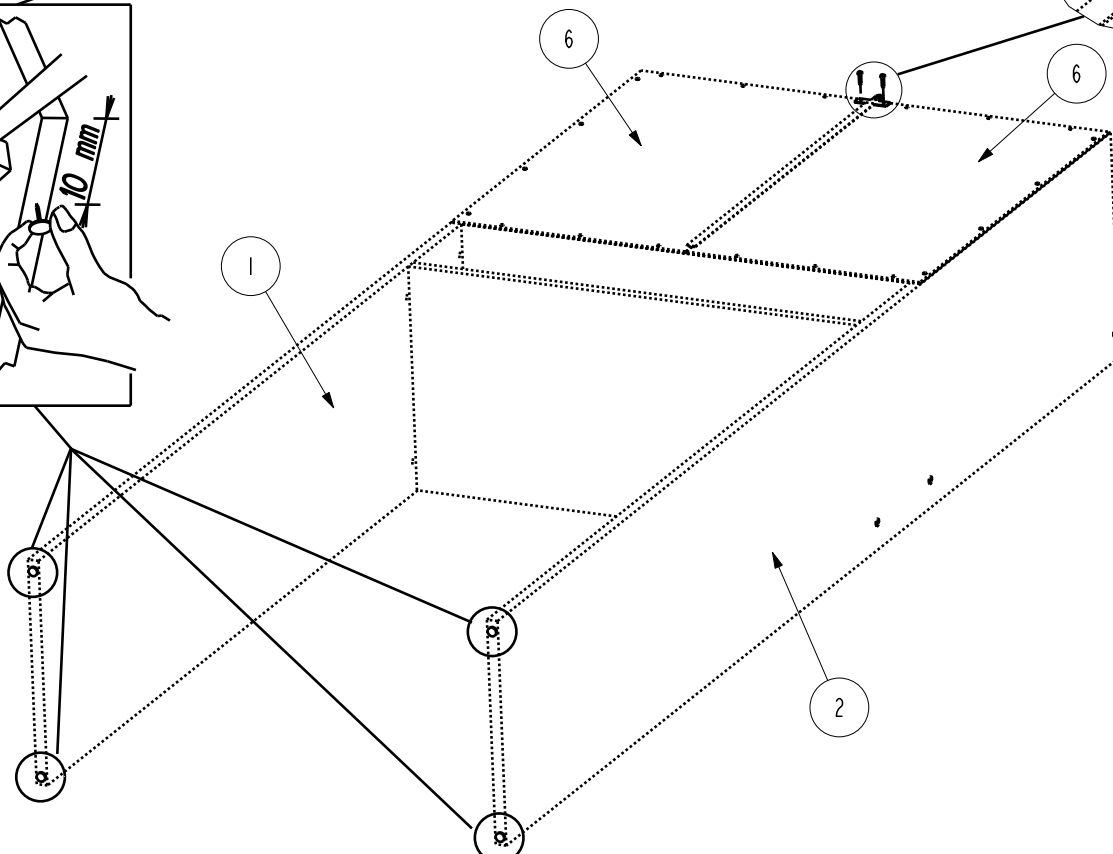
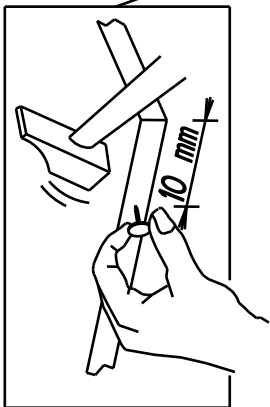

7

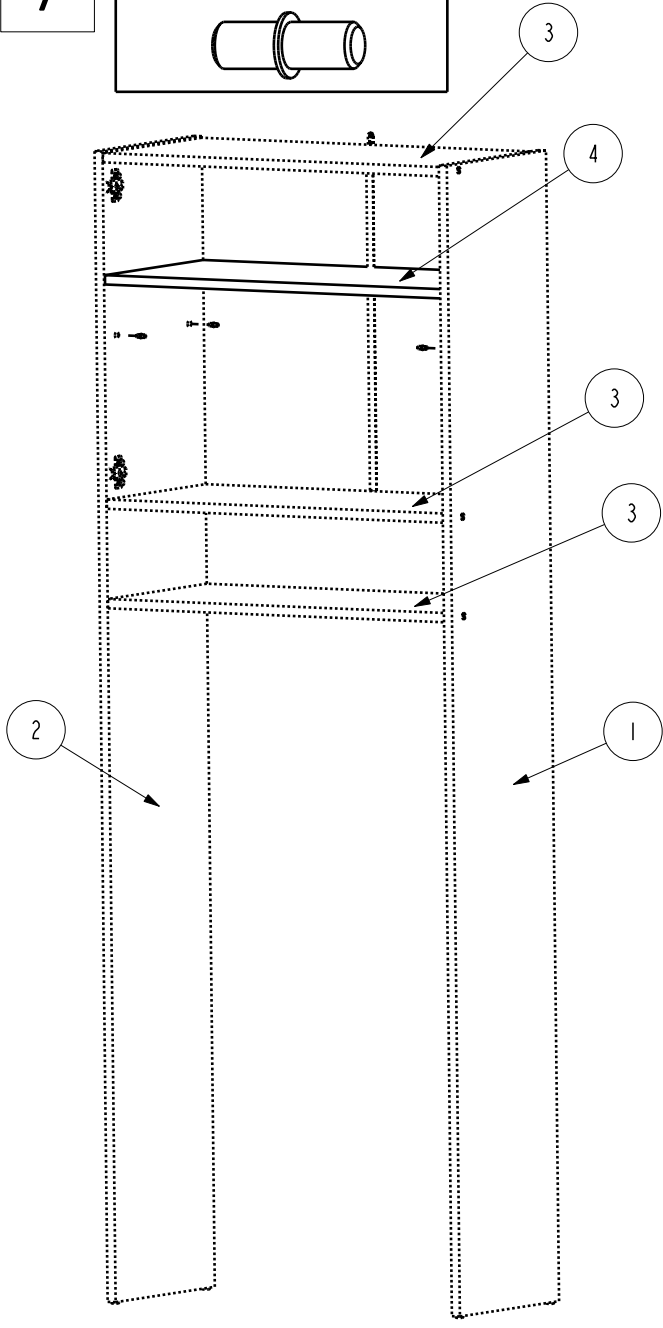
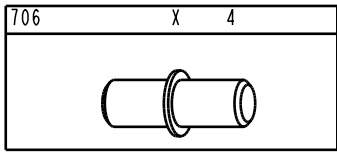

8

