

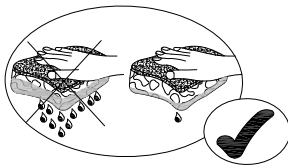

SAV
SPAREPARTS
KUNDEDIENST
POS VENTAS
SERVICE NA VERKOOP
SERVIZIO POST- VENDITA
SERVICO DEPOIS DE VENDA
SERWIS POGWARANCY JNY

257890-00
Trend

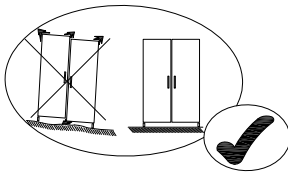
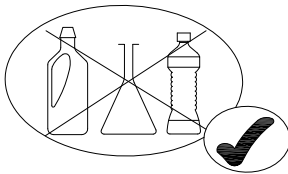

0H 30MN

(FR) SECURITE

RESPECTER LES INSTRUCTIONS DE MONTAGE DECRITES DANS LA NOTICE

(EN) CAUTION

FOLLOW CAREFULLY THE ASSEMBLING INSTRUCTIONS DESCRIBED IN THE DIRECTIONS

(DE) SICHERHEITSVORSCHRIFTEN

BEACHTEN SIE BITTE UNBEDINGT DIE ANGEGEBENEN AUFBAUVORSCHRIFTEN

(ES) SEGURIDAD

RESPECTAR LAS INSTRUCCIONES DE MONTAJE DESCRIBIDAS EN EL FOLLETO

(NL) VEILIGHEID

DE IN DE GEBRUIKSAANWIJZING BESCHREVEN INSTRUCTIES RESPECTEREN

(IT) SICUREZZA

RISPETTARE LE ISTRUZIONI DI MONTAGGIO DESCRITTE NEEL' AVVERTENZA

(PT) SEGURANCA

RESPEITAR AS INSTURAÇOS DE MONTAGEH DESCREVEDAS NA INSTRUÇÕES DE USO

(PL) UWAGA

PROSZĘ PRZESTRZEGAĆ INTRUCJI MONTAŻU

**Meuble à usage domestique / House furniture / Nur zum Hausslichem Gebrauch / Mueble a uso domestico
Meubel voor eigen gebruik / Mobile per abitazion / Movel a uso domestico / Mebel Domowego**

178 to 184 rue de la Prévoté BP 49-59840 PERENCHIES-France

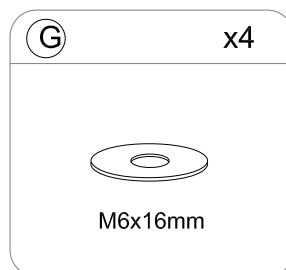
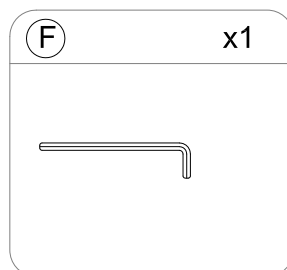
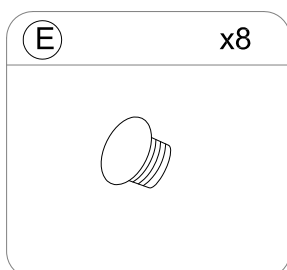
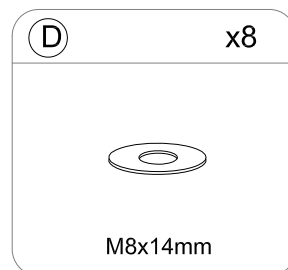
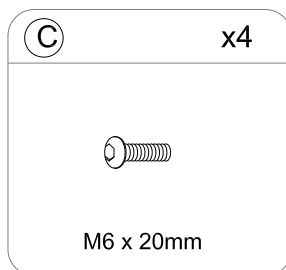
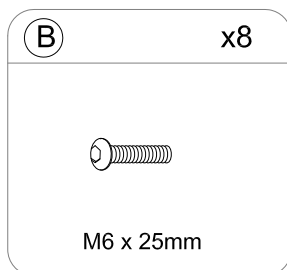
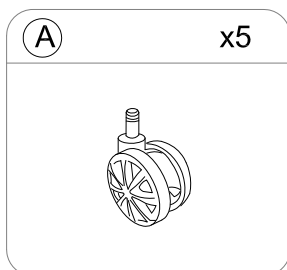
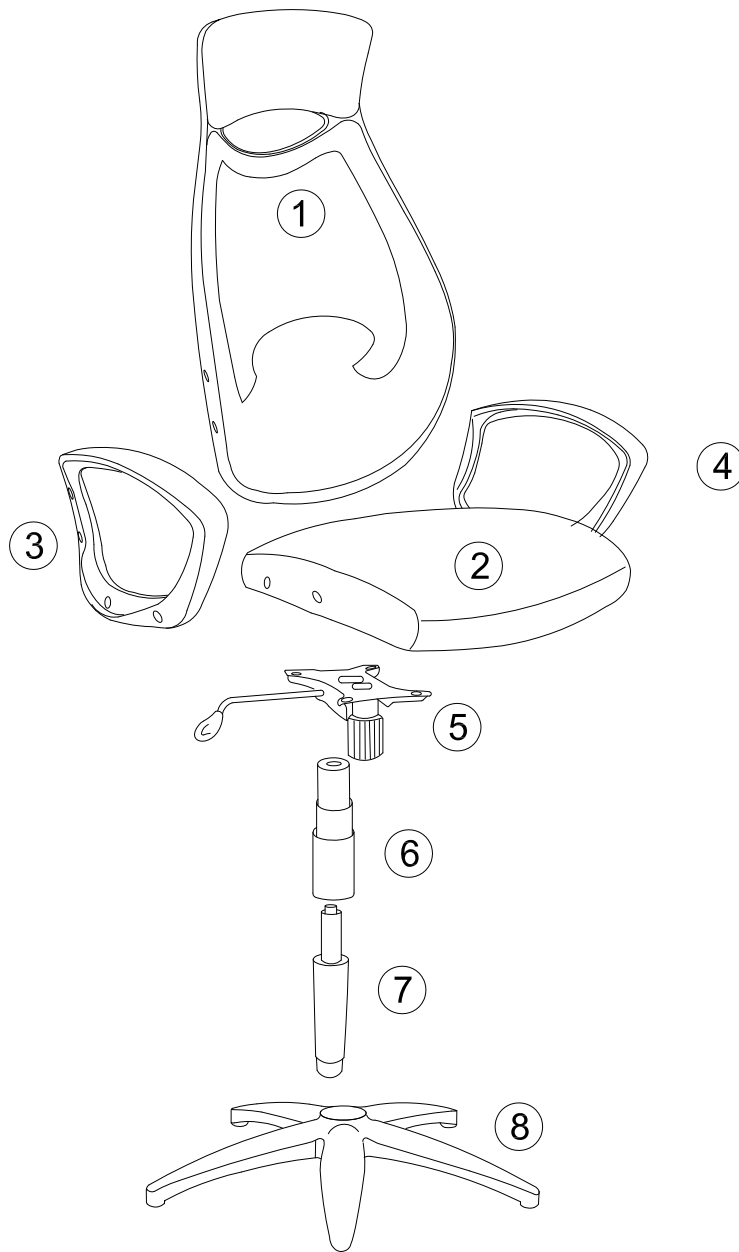

1

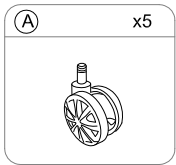
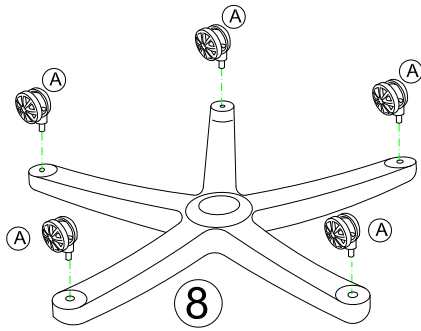

2

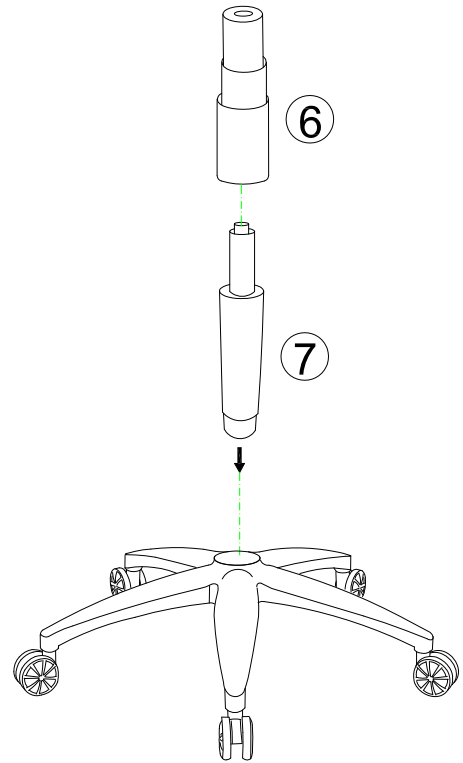

3

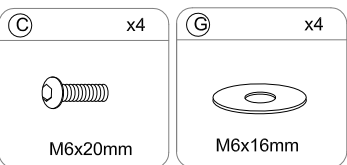
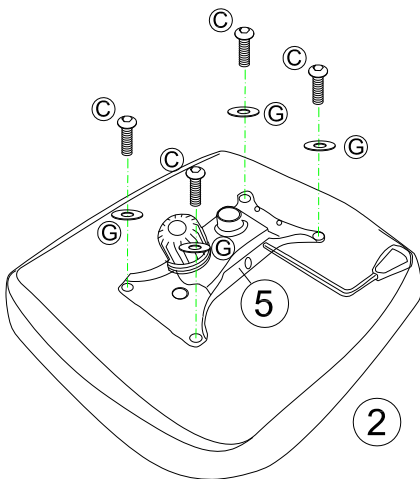

4

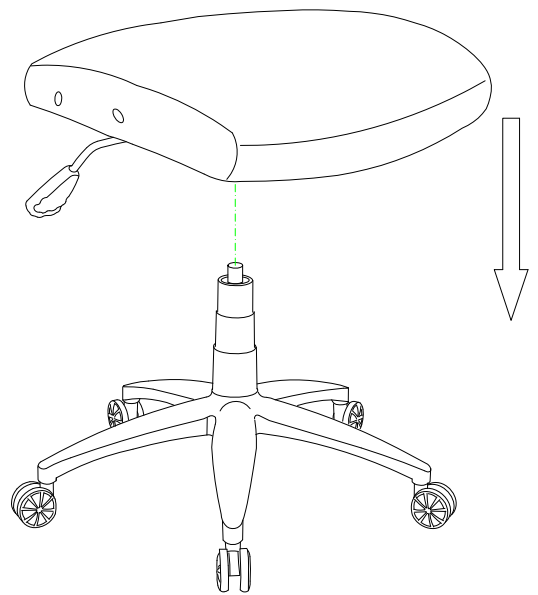

5

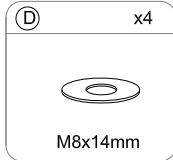
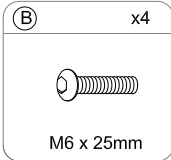
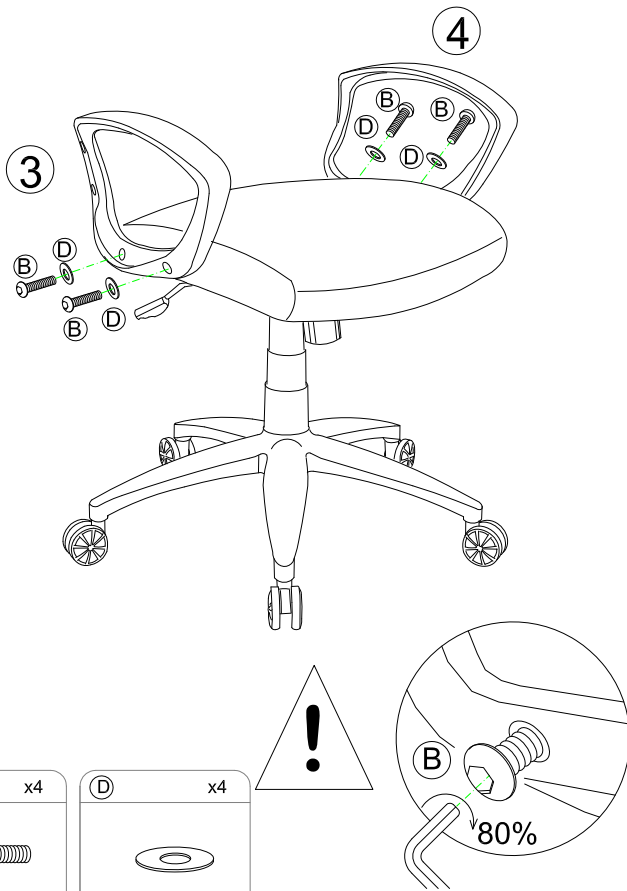

6

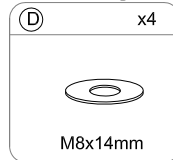
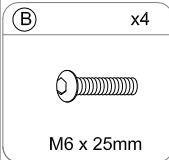
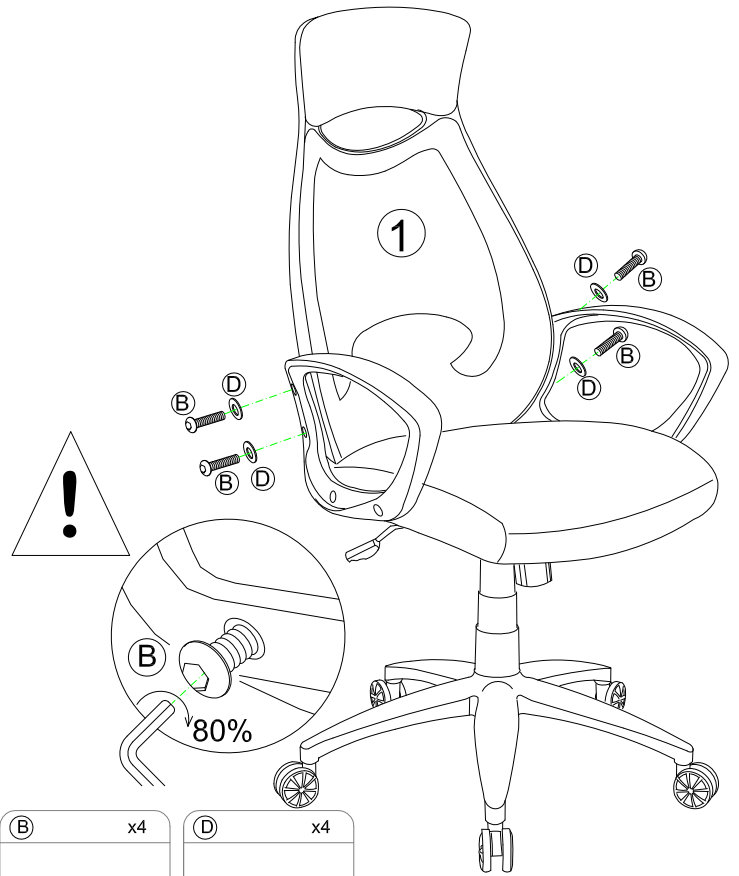

7

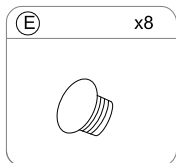
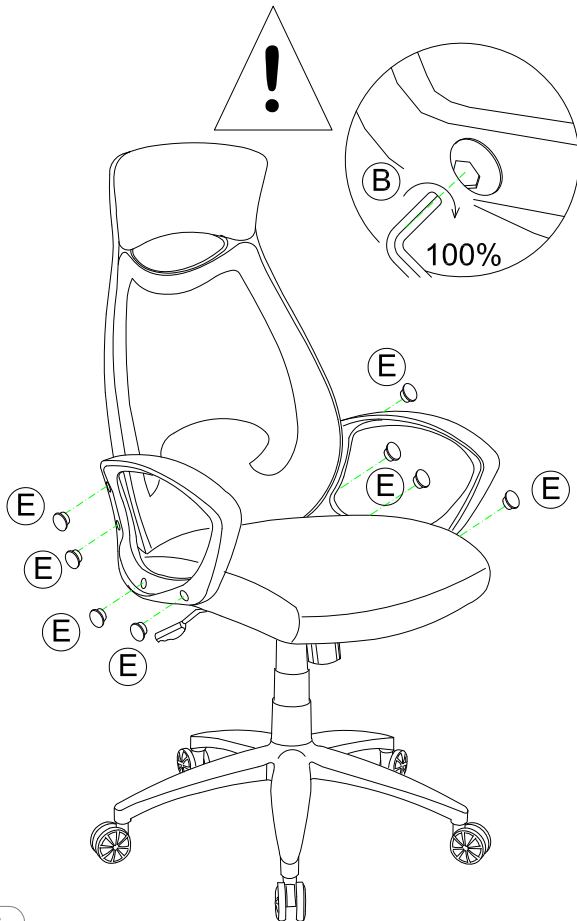

8



FR - Le dispositif de réglage en hauteur de ce siège comporte une pompe à accumulation d'énergie, seul un personnel formé peut remplacer ou réparer ce dispositif.

GB - The device to adjust this seat height position includes an energy accumulator, only trained people may repair or replace this device.

ALL - Die Vorrichtung zur Höhenverstellung des Sitzes hat eine Energiespeicherungspumpe, nur geschultes Personal kann diese ersetzen oder reparieren .

ESP – El dispositivo para la regulación de la altura del asiento tiene una bomba de acumulación de energía, sólo personal capacitado puede reemplazarlo o repararlo.

ITA – Il dispositivo di regolazione in altezza di questa sedia contiene una pompa ad accumulazione di energia, solo un personale formato può sostituire o riparare questo dispositivo.

NEL – De hoogte regeling van de stoel bevat een gaspomp. De vervanging van deze pomp mag alleen uitgevoerd worden door vakpersoneel.

POL – Urządzenie do regulacji wysokości siedzenia zawiera pompę magazynowania energii, tylko wyszkoleni ludzie mogą naprawić lub wymienić urządzenie.

POR - O dispositivo de ajuste da altura do assento inclui uma bomba com acumulação de energia, a reparação só pode ser realizada por técnico capacitado.



Info tri déchets

www.quefairedemesdechets.fr