

A	B	C	D	
1	S172-101	900	330	1/1
2	S172-102	900	330	1/1
3	S172-204	600	333	1/1
4	S172-310	569	327	1/1
5	S172-311	569	320	1/1
6	S172-408	569	60	1/1
7	S172-9903	850	593	1/1

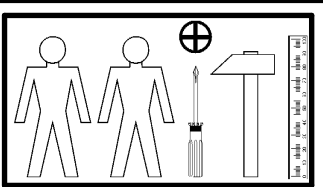
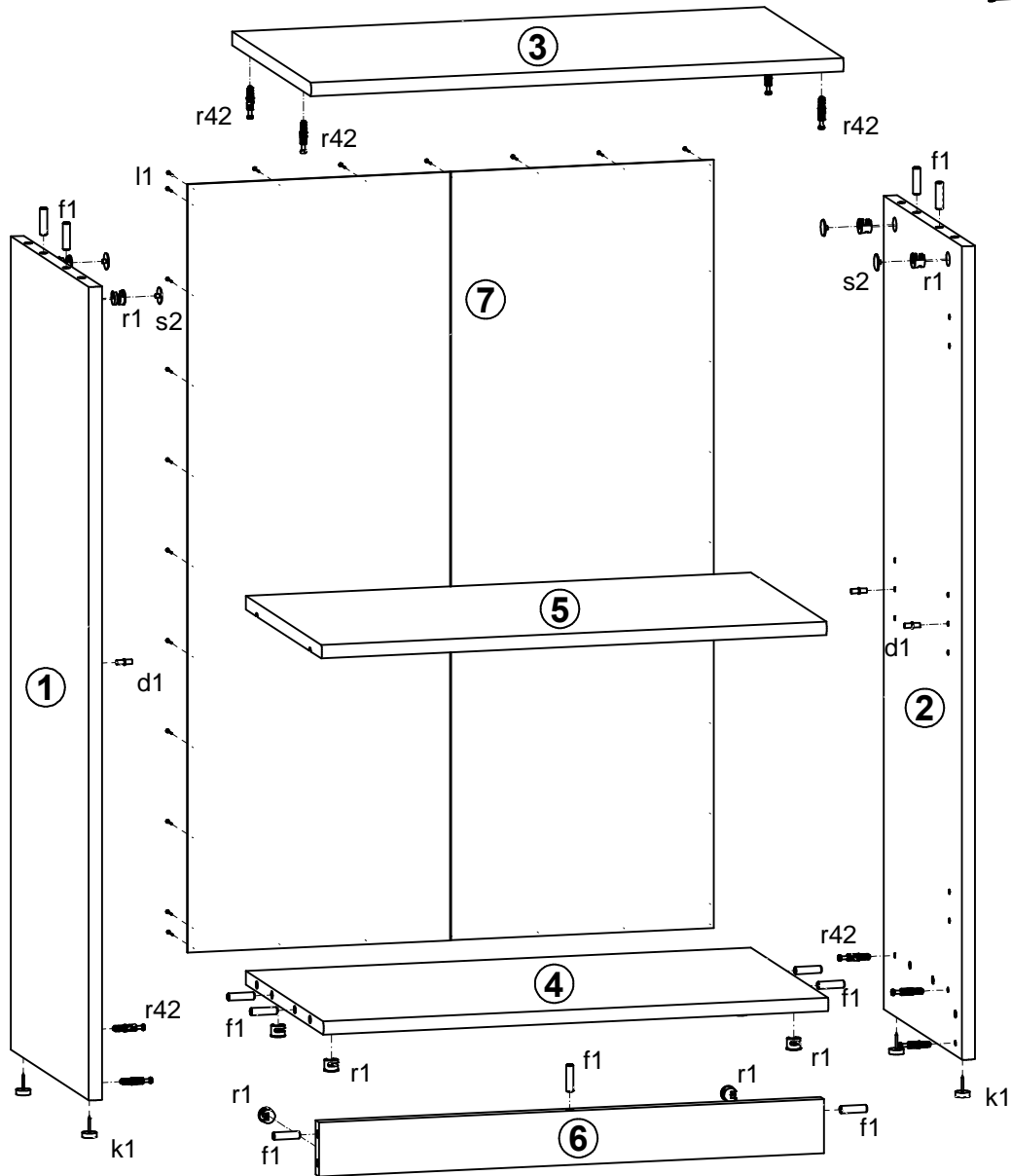
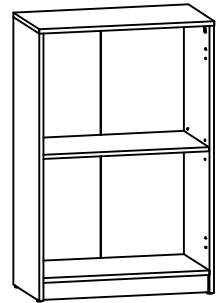

4x Ø5x17 mm d1	11x Ø8x30 mm f1	4x k1	32x l1	10x Ø15x12 mm #16 r1	10x r42	4x Ø16 s2	1x n26/1	1x Ø3.5x16 mm p38
----------------------	-----------------------	----------	-----------	----------------------------	------------	-----------------	-------------	-------------------------