

5

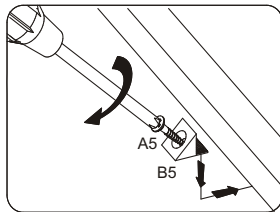

6

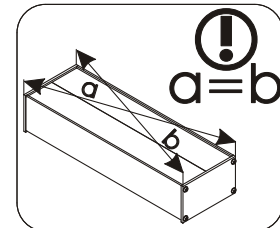
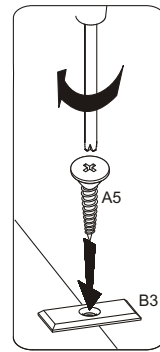
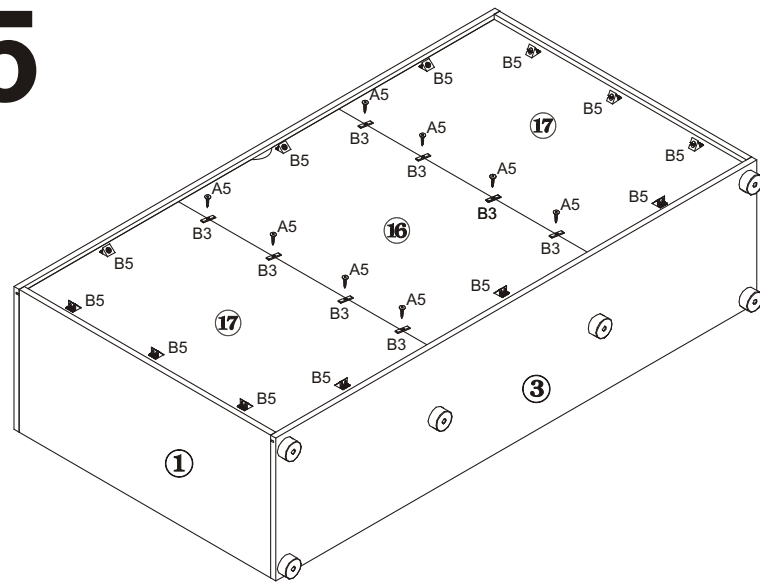
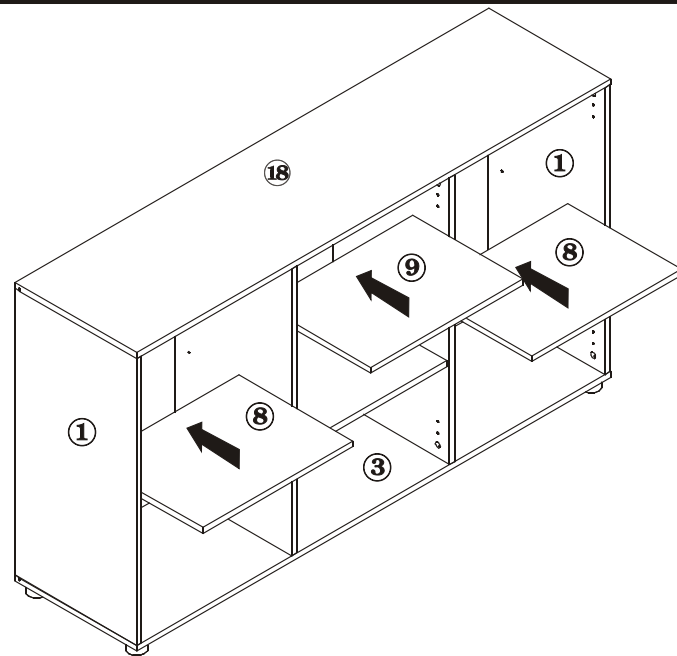

7

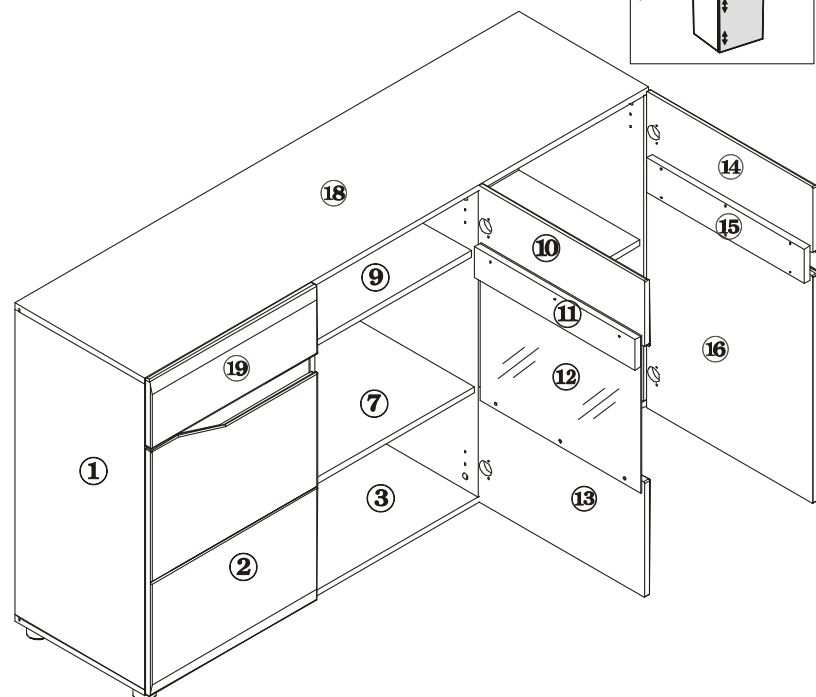
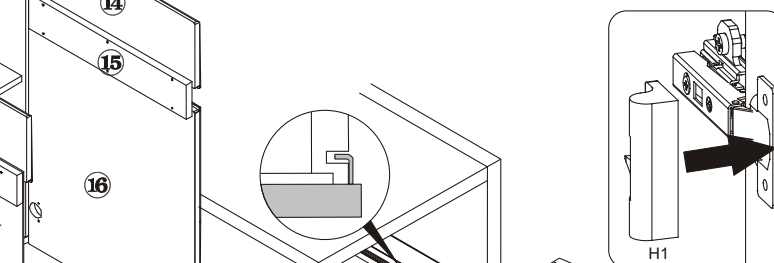
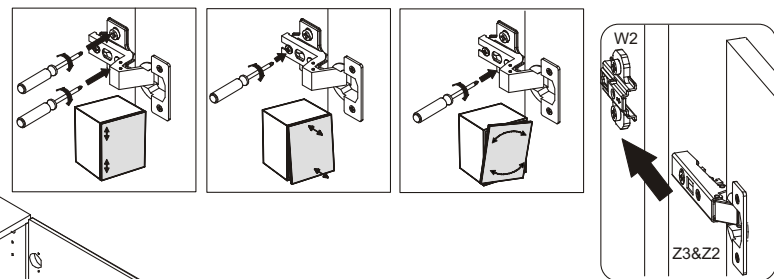

LIONEL

KREDENS-LI4

- (D) Montageanleitung
- (GB) Assembly instructions
- (ES) Instrucciones de instalación
- (FR) Instructions de montage
- (CZ) Montážní návod
- (PL) Instrukcja montażu
- (HU) Összeszerelési útmutató
- (SK) Montážny návod
- (RU) Инструкции по монтажу
- (IT) Istruzioni di montaggio
- (RO) Instrucțiuni de asamblare
- (TR) Montaj talimatı
- (NL) Handleiding voor de montage

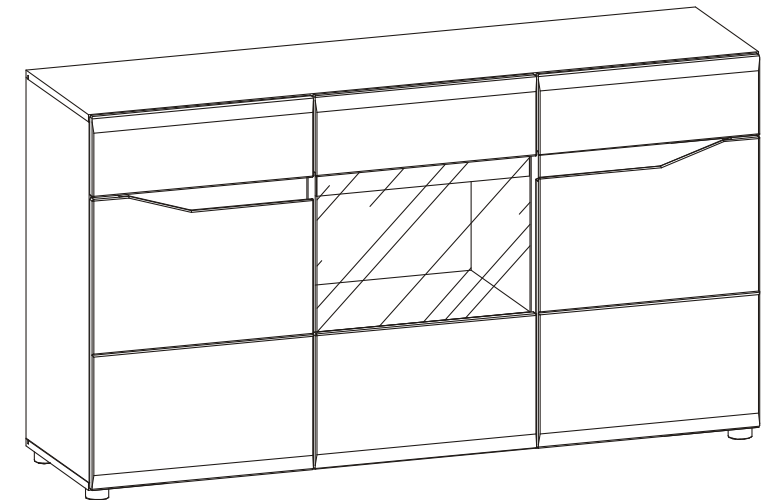

1500x405x850

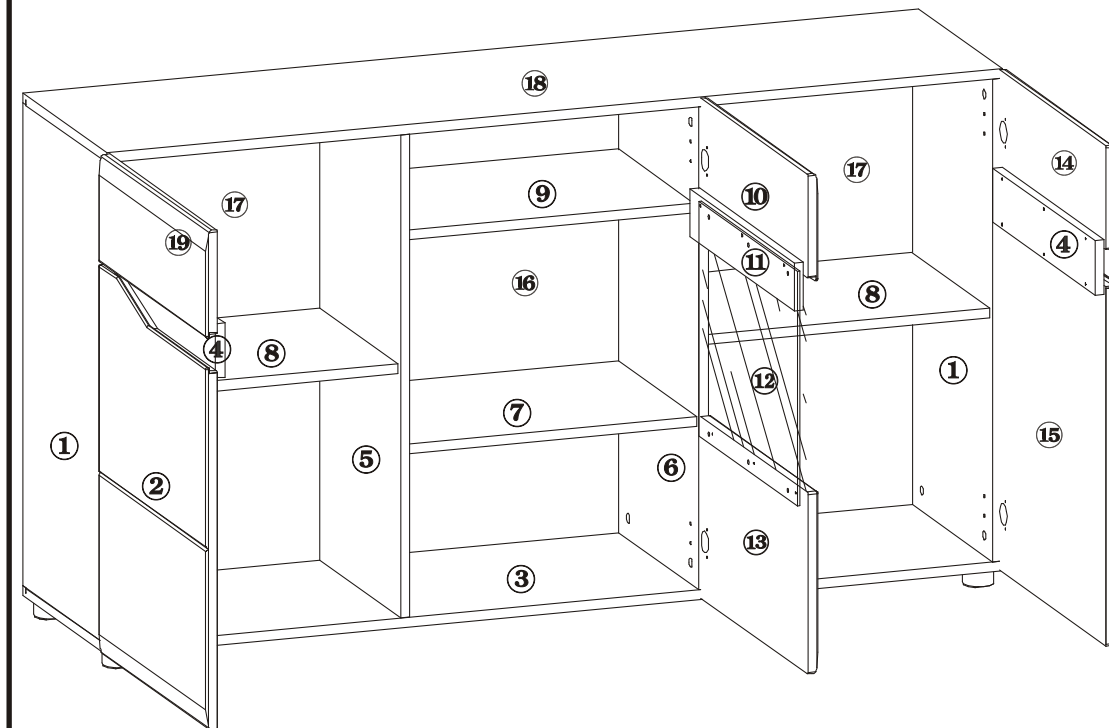

Lp.	A		
12	403x478		
11	478x78		
10	496x175		
9	483x360		
8	475x360		
7	484x360	19	496x175
6	786x370	18	1501x386
5	786x370	17	801x491
4	470x88	16	801x501
3	1501x386	15	635x496
2	635x496	14	496x175
1	786x386	13	496x296

