

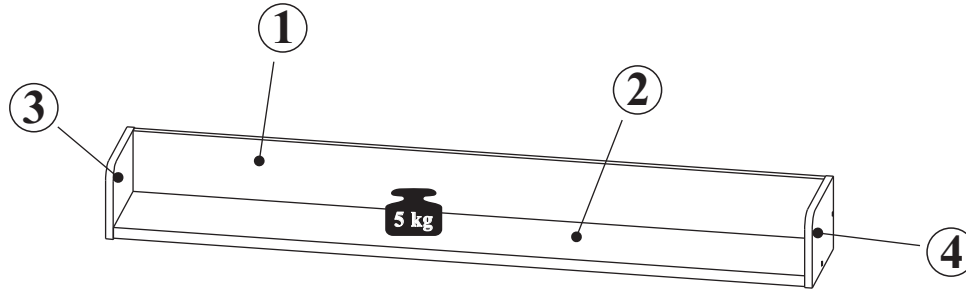

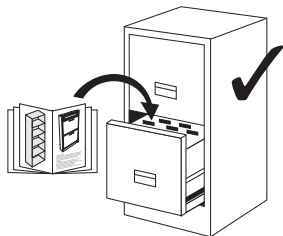

Modellname: **LOTUS**  
Nazwa modelu:



Modellreihe: **P9--LS**  
Nr. modelu

Type: **53**  
Typ:

Blatt Nr **1** von: **2**  
Strona z:



- NR 1**
- B1**   $\phi$  8x28 x4
  - K1**  x9
  - IS4**  x1
  - C1**   $\phi$  2 x4

- NR 2**
- F50**  x2
  - E2**  x4

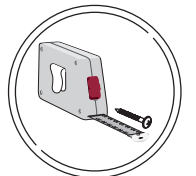
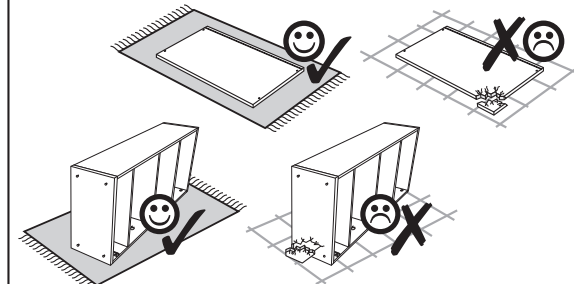
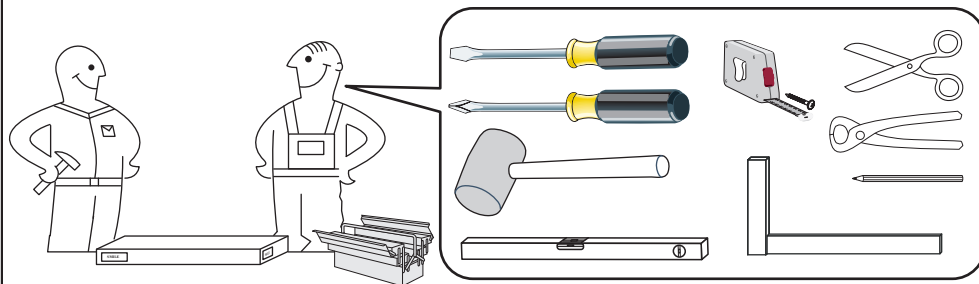

**1**

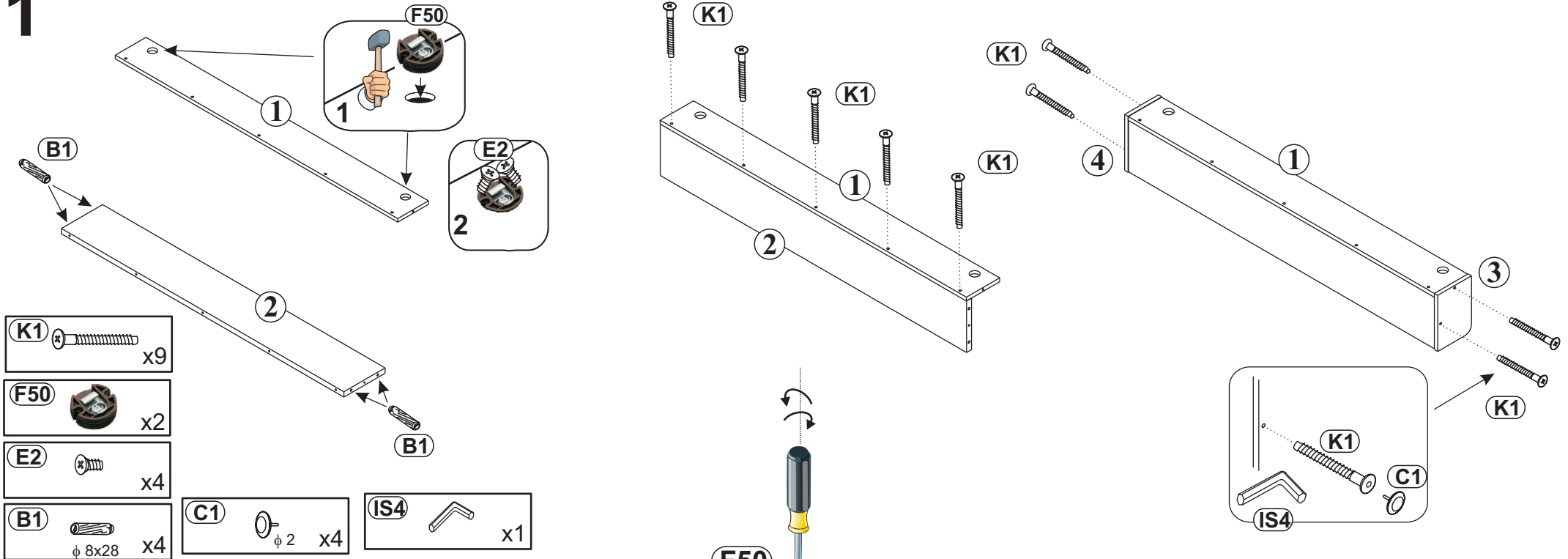

**2**

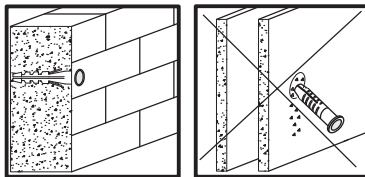

- (PL)** Załączone kołki do zawieszania bryły, do stosowania wyłącznie do ścian betonowych, do innych ścian należy odpowiednio dokupić.
- (GB)** Attached dowels to hang up unit are for concrete walls only. For other types of walls, appropriate dowels must be purchased
- (D)** Die beigefügten Dübel zum Aufhängen des Elements dürfen nur bei Betonwänden eingesetzt werden, bei anderen Wandarten müssen entsprechende Dübel zugekauft werden.
- (F)** Les chevilles jointes, pour pendre l'élément, sont pour les murs bétonnés exclusivement; pour autres murs il faut acheter chevilles adéquates

