

Modellname: **LOTUS**  
 Nazwa modelu:

Modellreihe: **P9--LS**  
 Nr. modelu

Type: **46**  
 Typ:

Blatt Nr **1** von: **5**  
 Strona z:

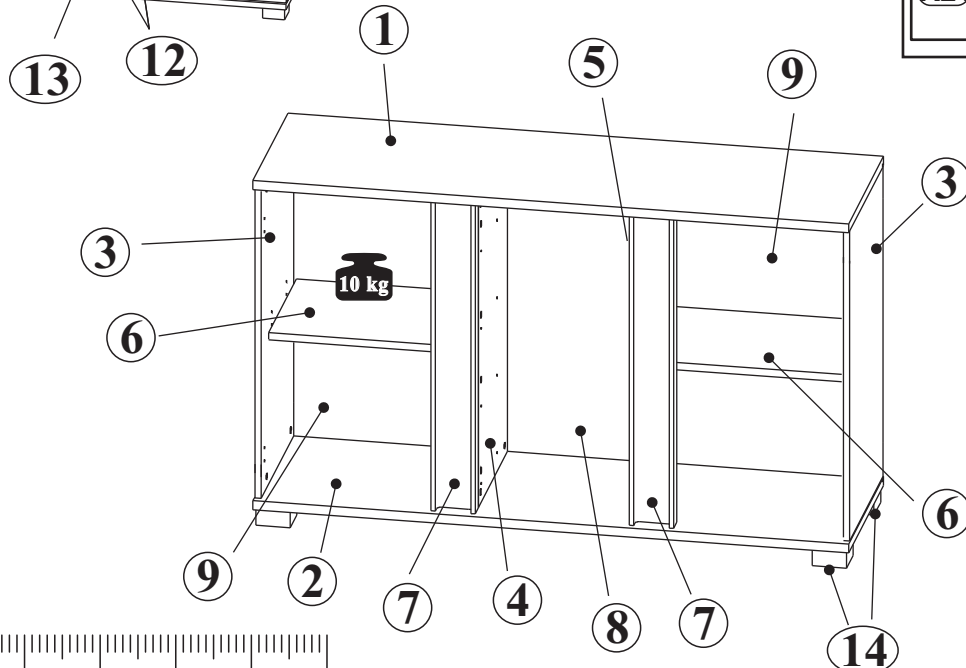
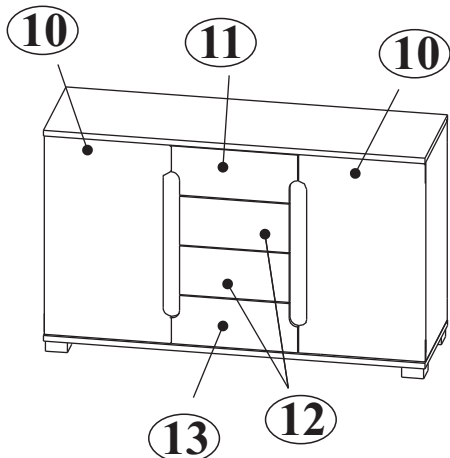
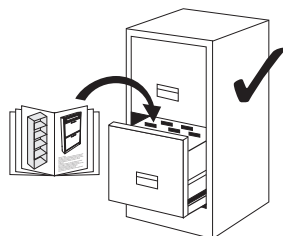



**NR 6**

**F12**  x4

**P13**  3,5x13 x16

**Nr 5**

**S3**  3,5x13 x16

**E2**  6x8 x16

**R21**  x4

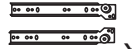
**R21**  x4

**NR 3**

**J23**  x8

**P3**  3,5x18 x8

**F1**  x8

**NR 4**

**P13**  3,5x13 x2

**J11**  x1

**NR 1**

**B1**   $\phi$  8x28 x26

**L1**  x2

**M1**  x24

**T1**  x24

**C2**  x24

**W1**  x6

**NR 2**

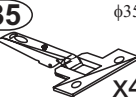
**Z0035**   $\phi$ 35 x4

**PZ352**  x4

**E3**  6,3x13 x8

**S8**  4x13 mm x8

**C3**  x8

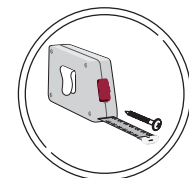
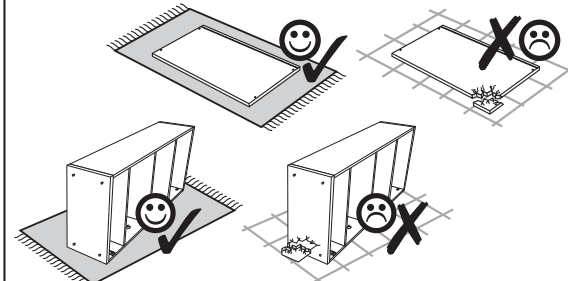
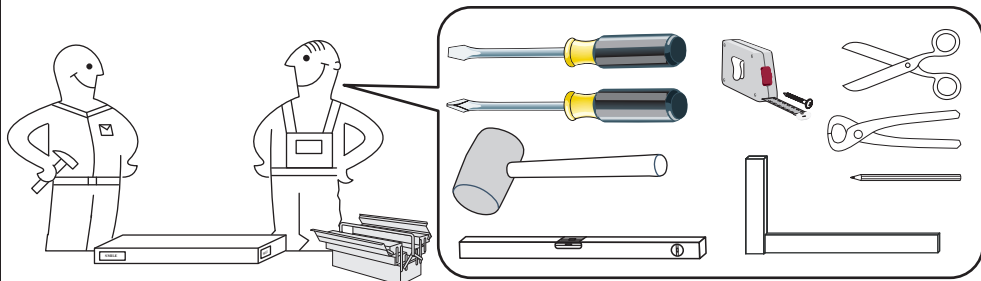

**1**

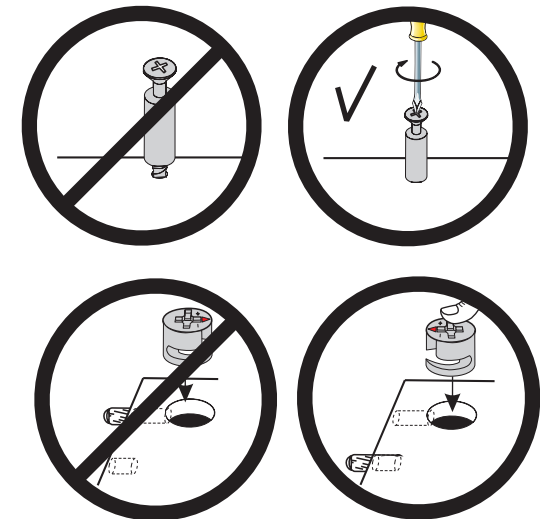
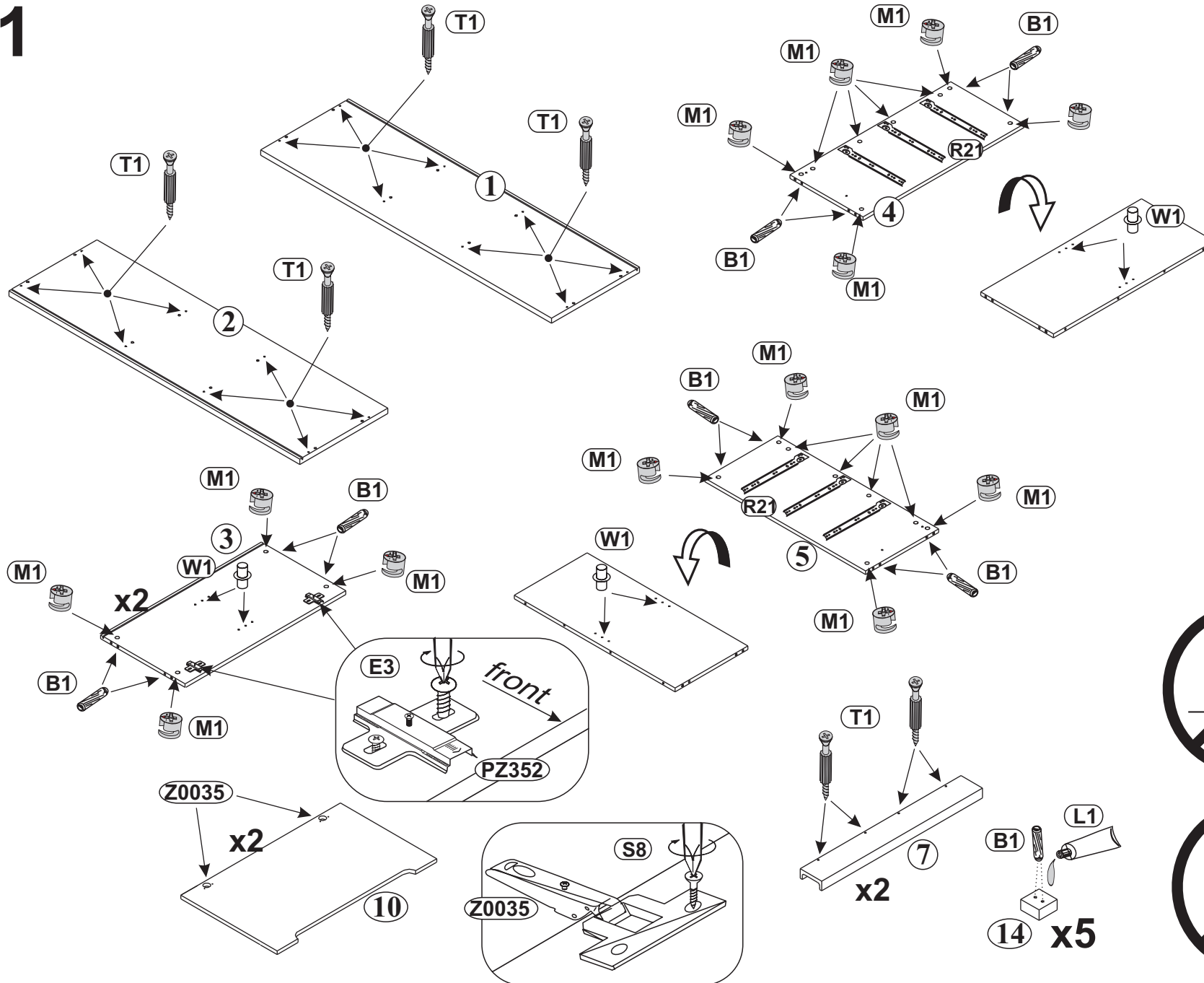

**2**

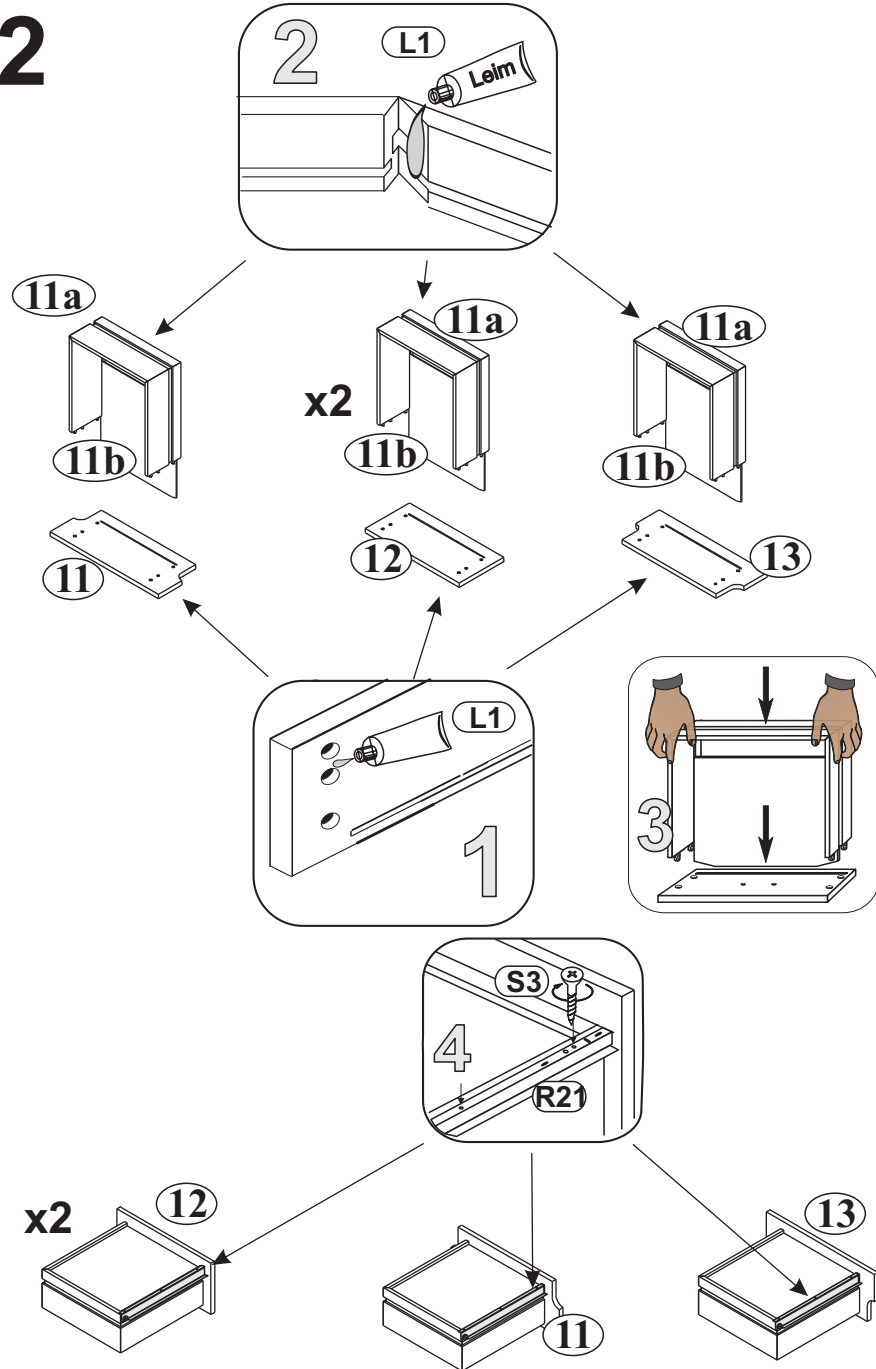

**3**

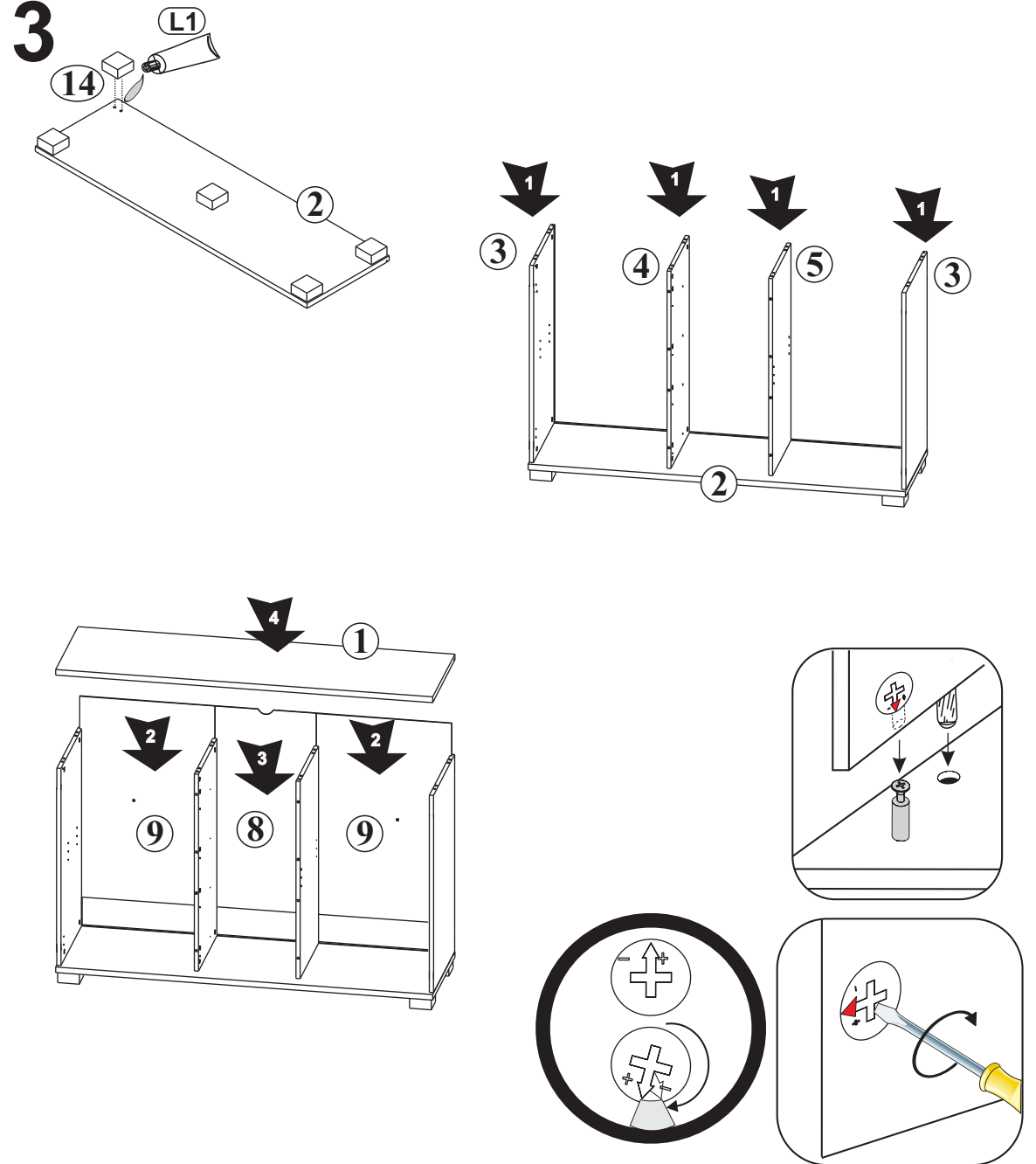

**4**

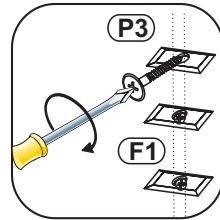
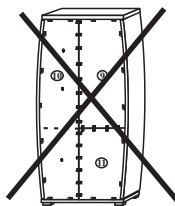
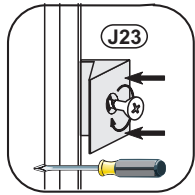
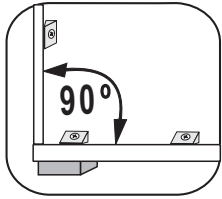
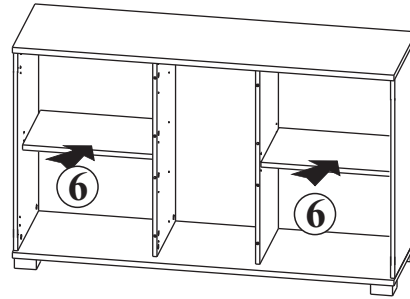
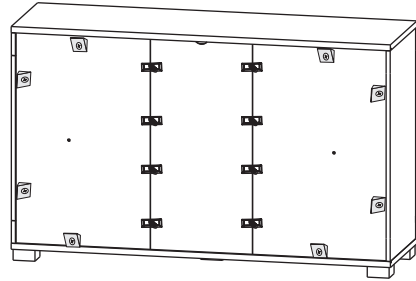

**5**

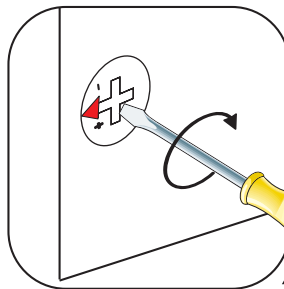
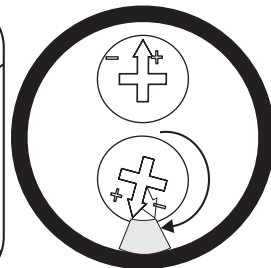
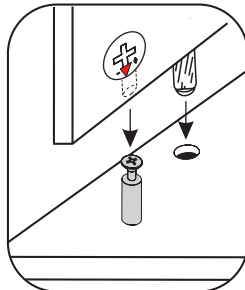
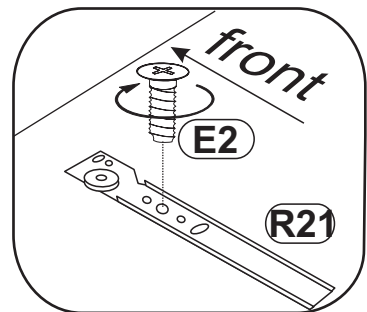
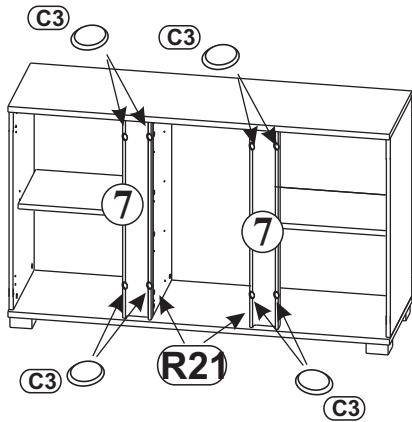

**6**

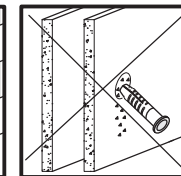
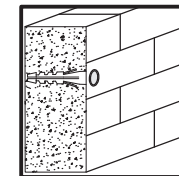
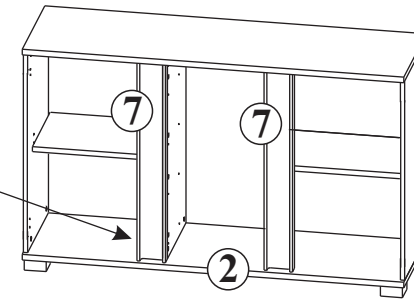
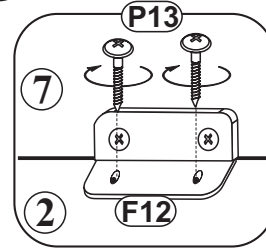

<b>PL</b>	Załączone kołki do zawieszania bryły, do stosowania wyłącznie do ścian betonowych, do innych ścian należy odpowiednio dokupić.
<b>GB</b>	Attached dowels to hang up unit are for concrete walls only. For other types of walls, appropriate dowels must be purchased
<b>D</b>	Die beigefügten Dübel zum Aufhängen des Elements dürfen nur bei Betonwänden eingesetzt werden, bei anderen Wandarten müssen entsprechende Dübel zugekauft werden.
<b>F</b>	Les chevilles jointes, pour pendre l'élément, sont pour les murs bétonnés exclusivement; pour autres murs il faut acheter chevilles adéquates

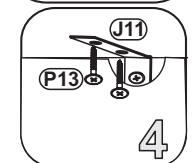
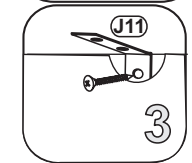
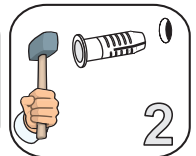
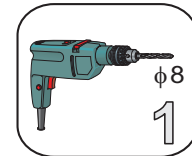

# 7

