

NR 3

R21 L-300 mm
x1L/1R

E1 6x11 x6

S3 3,5x13 x2

P3 3,0x13 x4

NR 4

T16 x1L+1R

F34 x2

T17 Ø10x50 mm
Ø6x45 mm x4

NR 5

O20 x1

O21 x1

NR 1

L1 x1

C2 x4

M1 x12

T1 x12

B1 φ 8x28 x16

W2 x4

S4 3,0x20 x5

J23 x18

NR 2

Y0 φ26
Kr0 x3

Y5 H0 x3

S8 4x13 mm x6

E3 6,3x13 x6



1

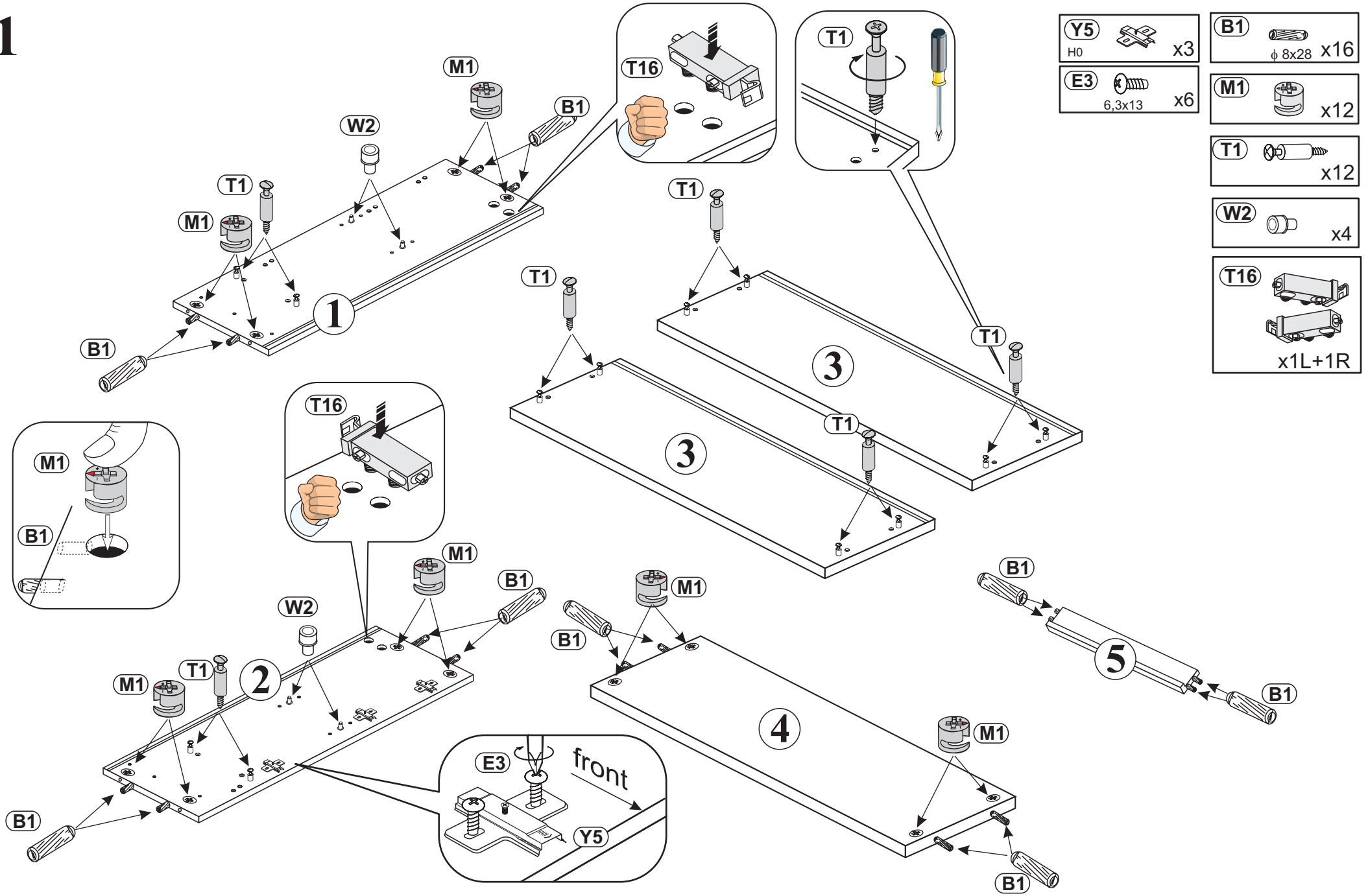

2

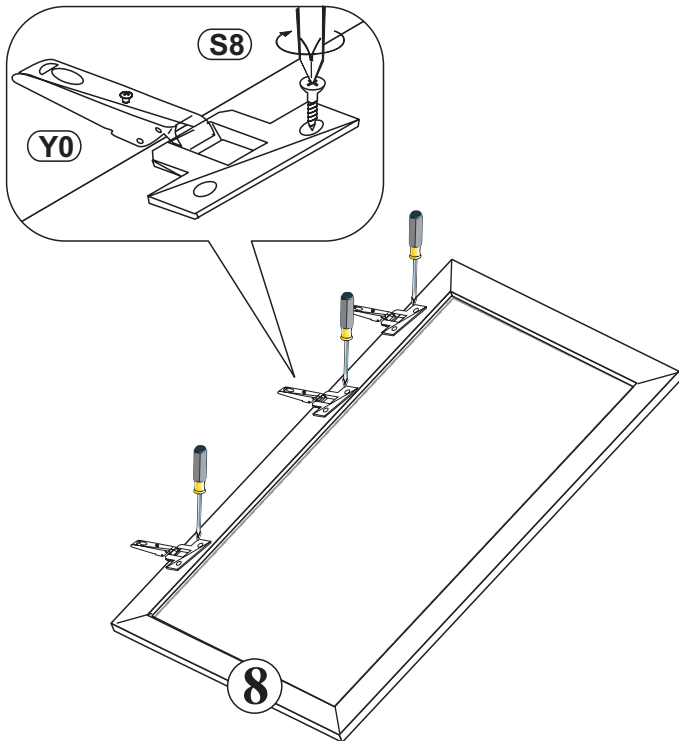
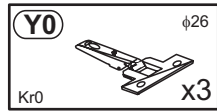

3

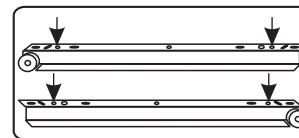
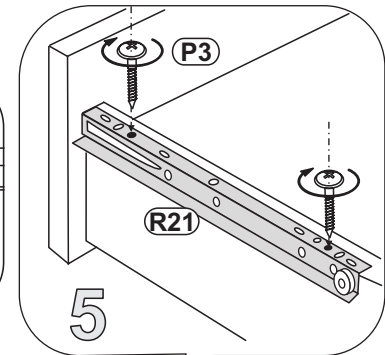
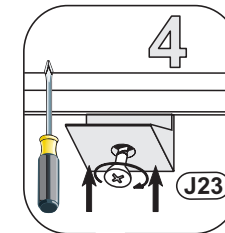
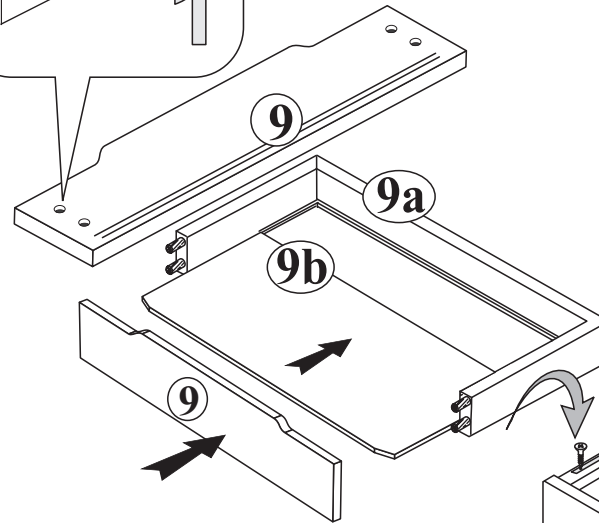
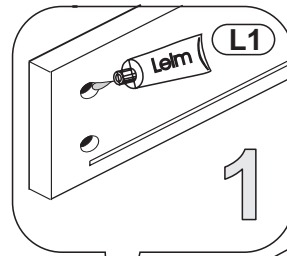
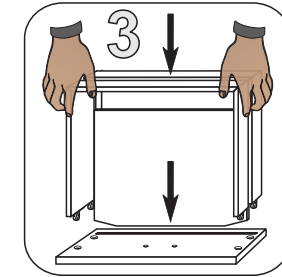
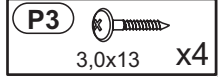
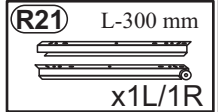
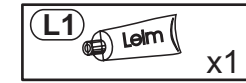
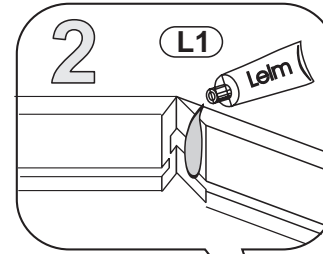

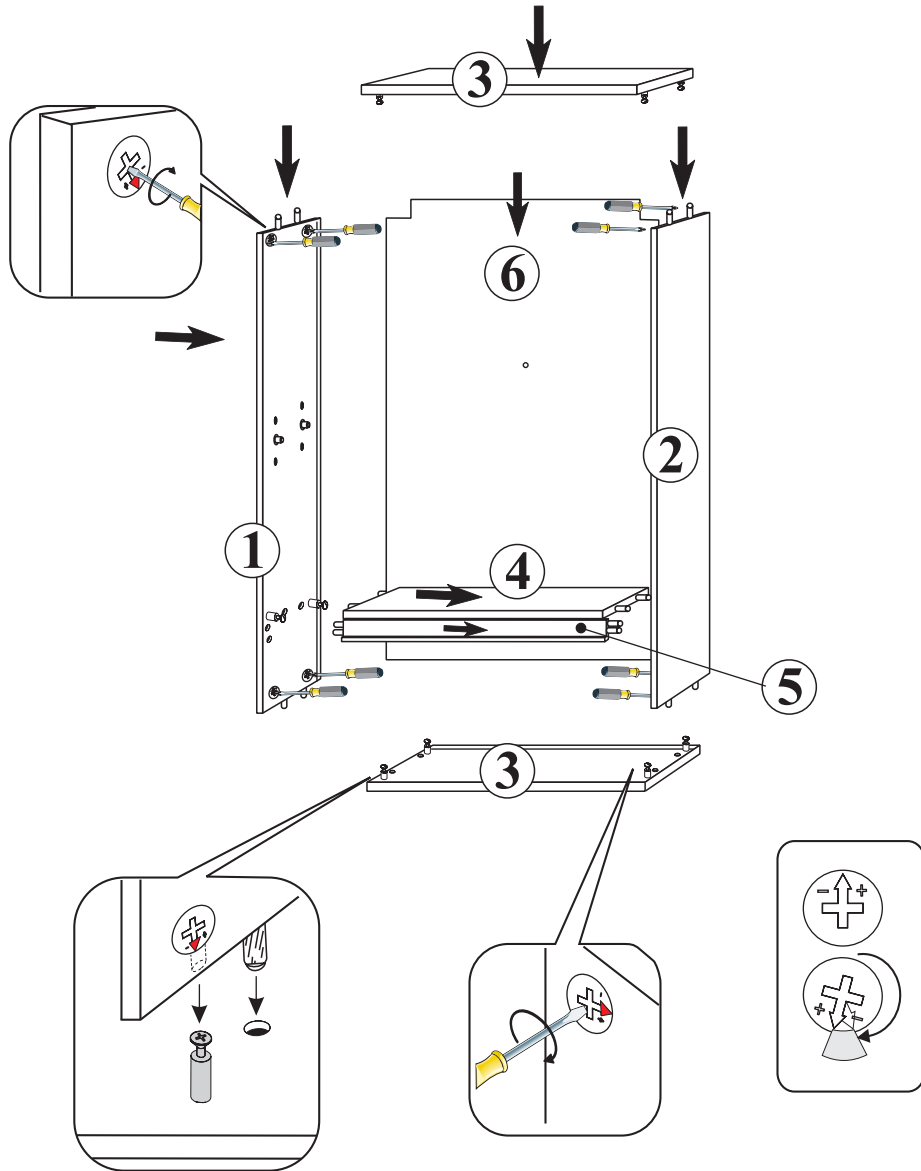

4

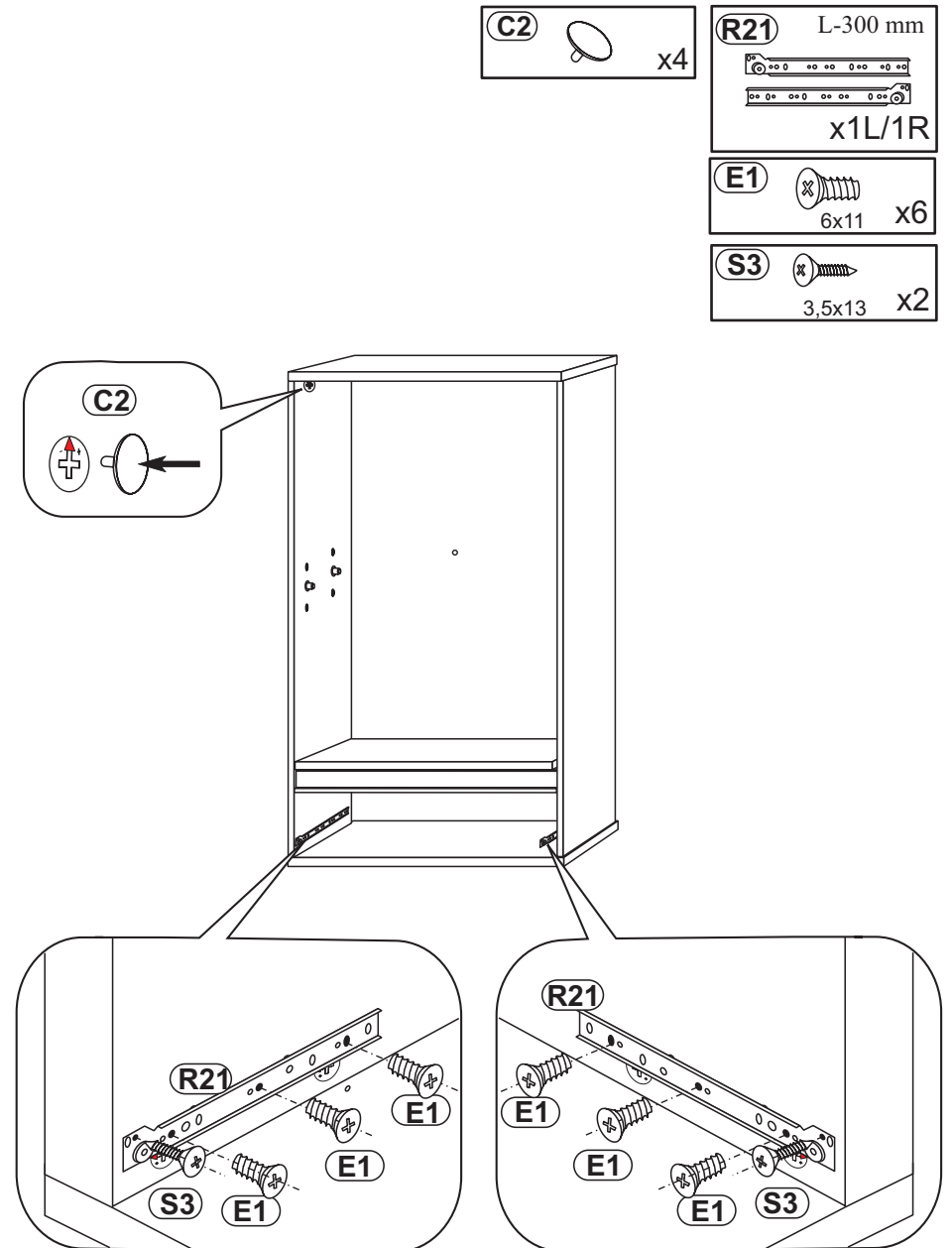

5



6

- S4  3,0x20 x5
- J23  x14

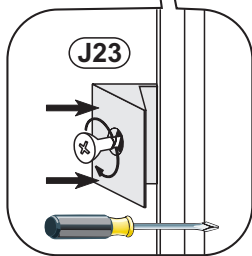
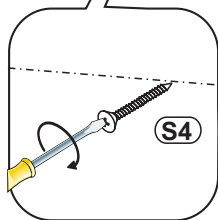
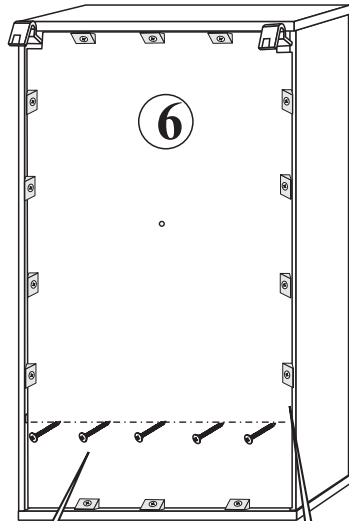

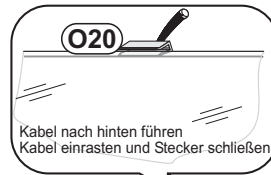

7

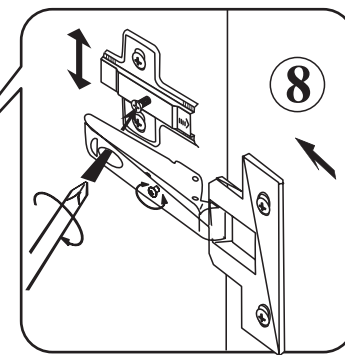
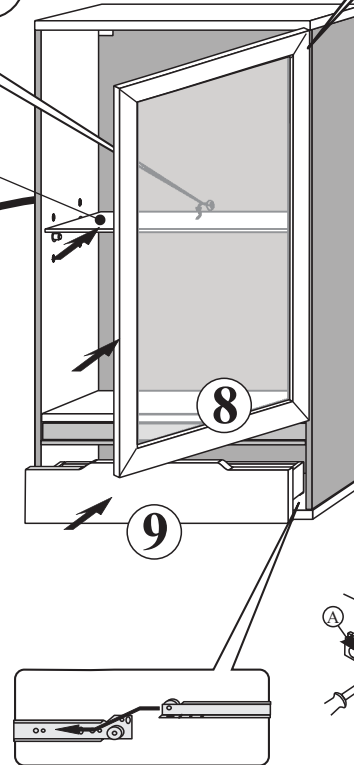
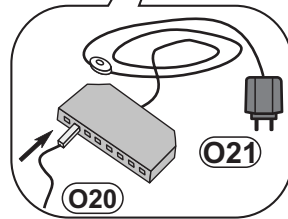

Anschluß für
Zubehörtype - Trafo



- O20  x1
- O21  x1

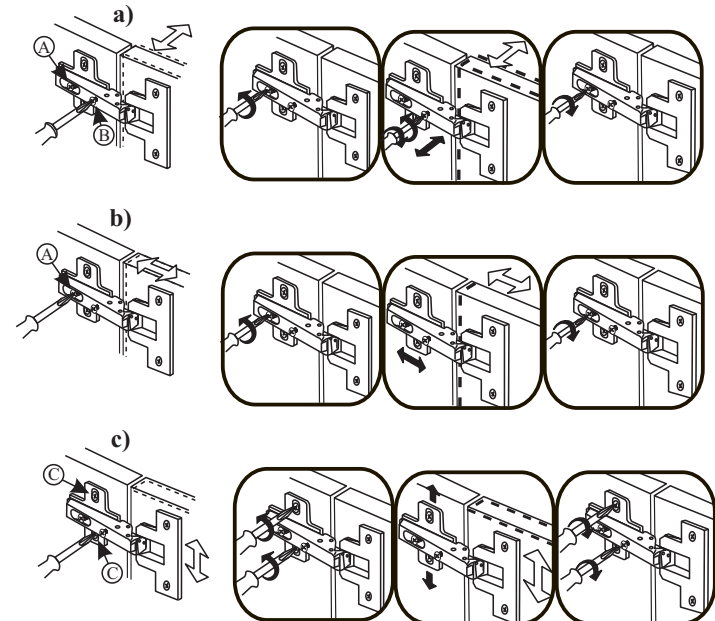

8

