

**CLINT
CLINT PLUS**

**P4--CT
P4--CP**

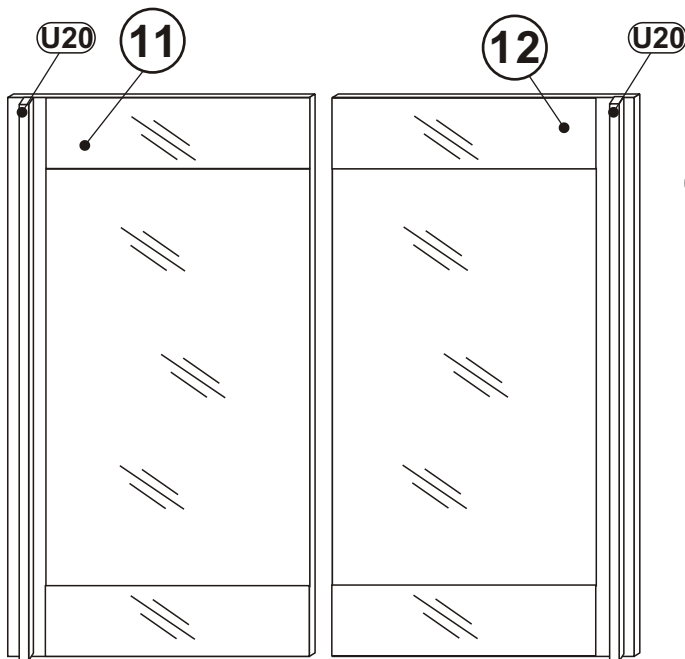

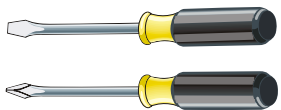
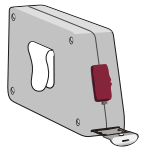
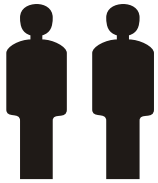
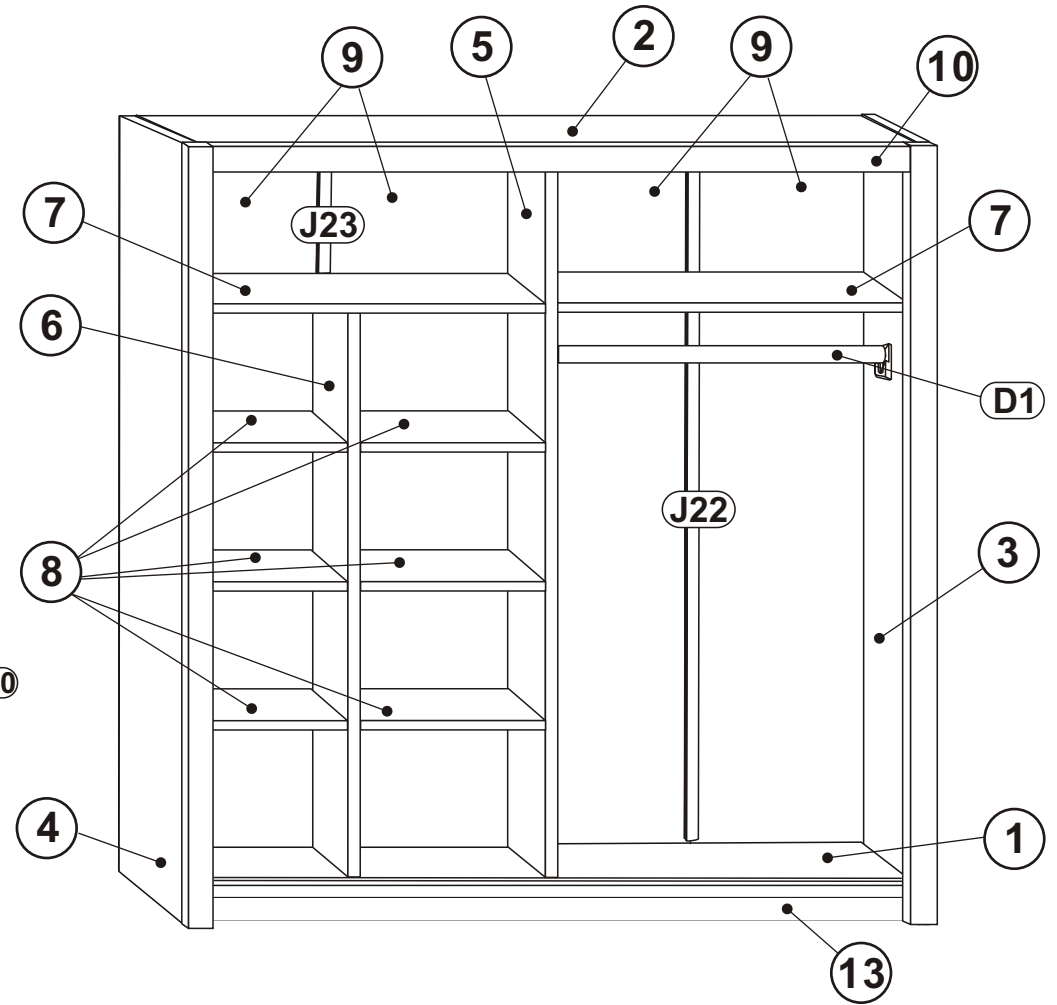
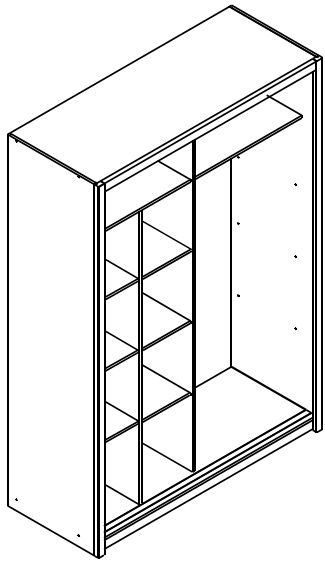

CLINT CLINT PLUS

P4--CT P4--CP

1

T6  x8

T1  x8

M1  x8

B1  8x28 x8+8

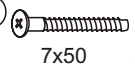
K1  7x50 x8

W1  x24

T2  x4

M2  x4

C1  2 x8

C2  x8

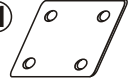
F11  x2

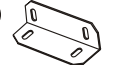
F12  x8

P13  3,5x13 mm X40

P33  x60

F1  x20

S4  3,0x20 x20

2

F7  x2

S2  3,0x13 x2

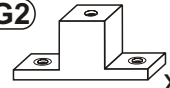
G2  x2

E3  6,3x13 x4

3

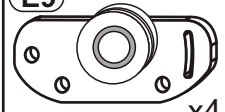
E9  x4

E1  6x11 x8

P13  3,5x13 x8

4

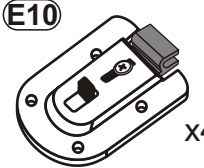
E10  x4

P13  3,5x13 x16

5

L4  x3

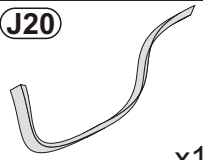
J20  x1

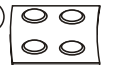
B2  x4

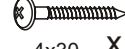
P5  4x30 x12

6

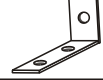
J11  x2

P13  3,5x13 mm x4

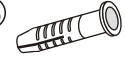
T13  x2

S15  x2

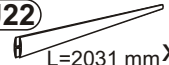
J22  L=2031 mm X1

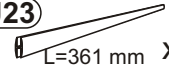
J23  L=361 mm X1

D1  L=969 mm X1

H1  x1





CLINT CLINT PLUS

P4--CT P4--CP

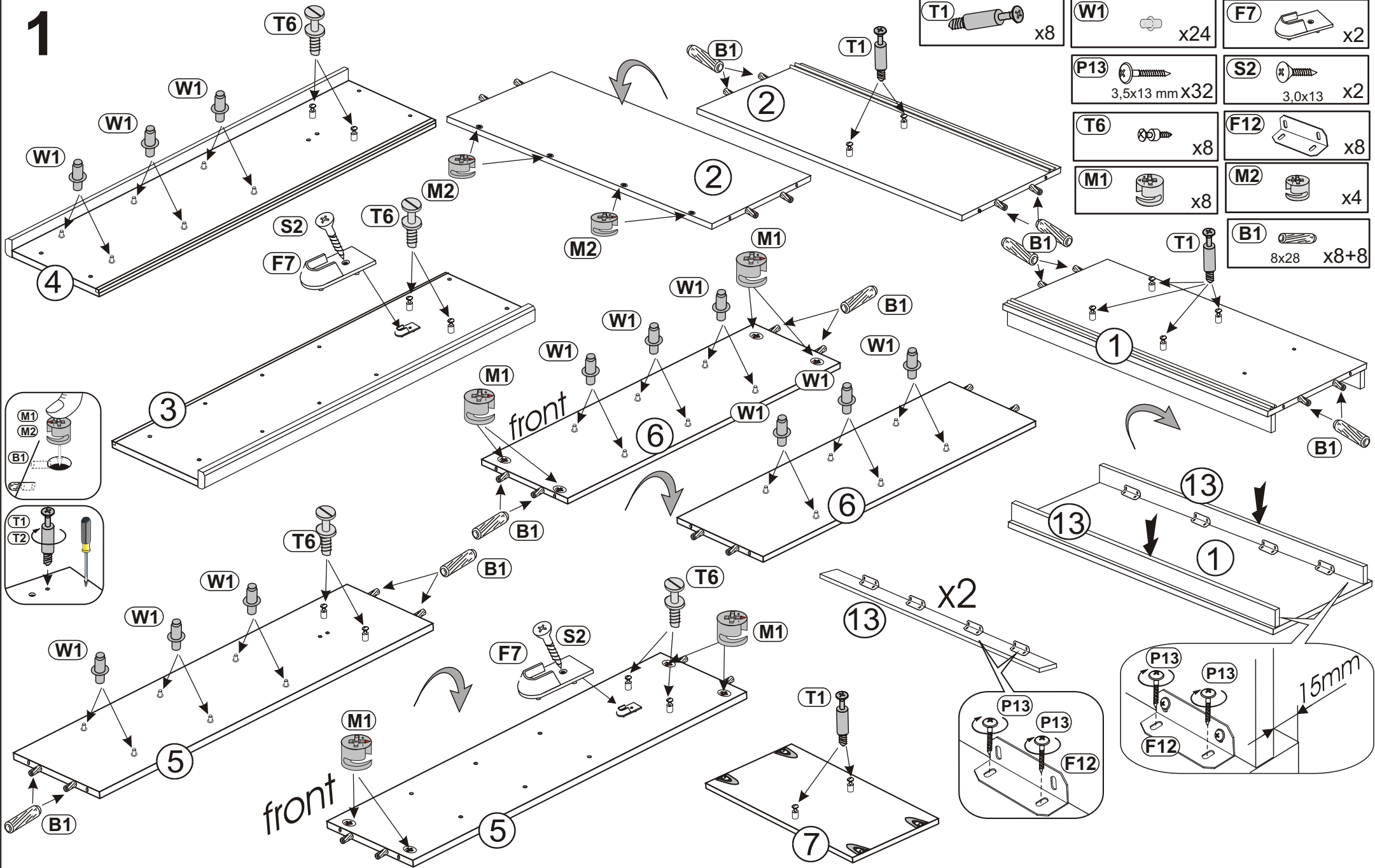
1

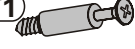



T1  x8

W1  x24

F7  x2

P13  3,5x13 mm X32

S2  3,0x13 x2

T6  x8

F12  x8

M1  x8

M2  x4

B1  8x28 x8+8

CLINT CLINT PLUS

P4--CT
P4--CP

4/7

2

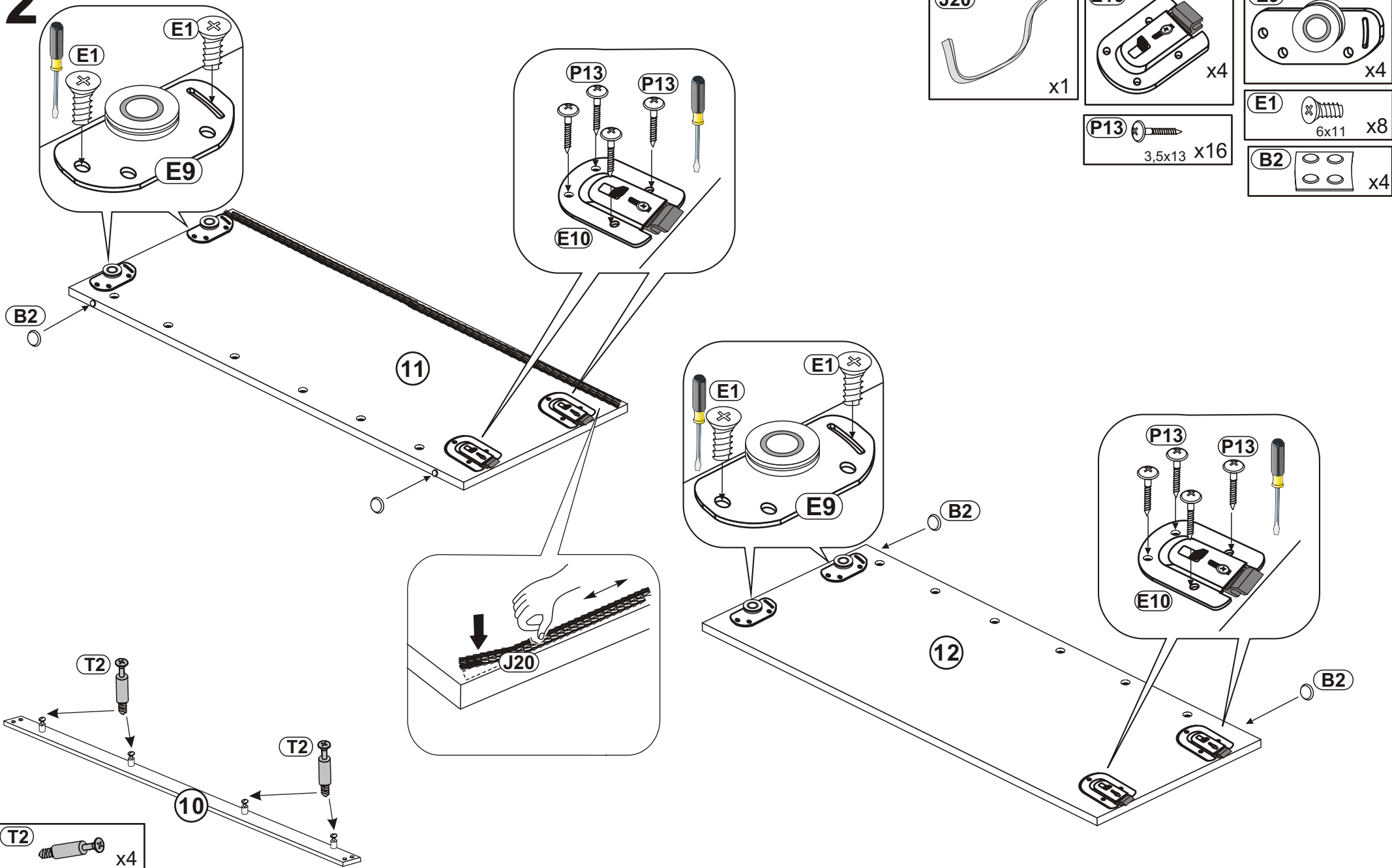

CLINT CLINT PLUS

P4--CT
P4--CP

5/7

3

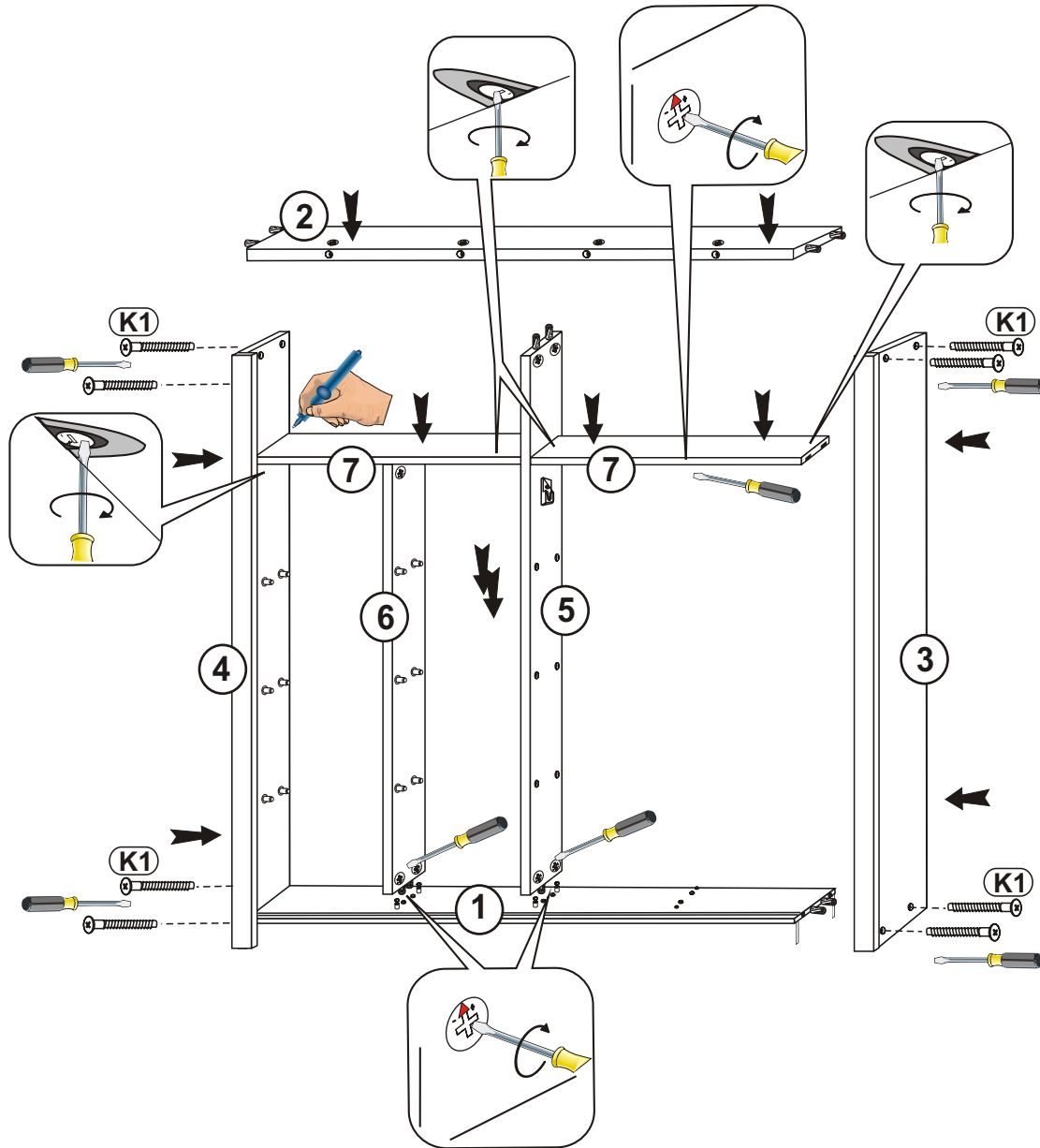
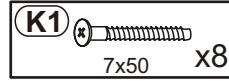

4

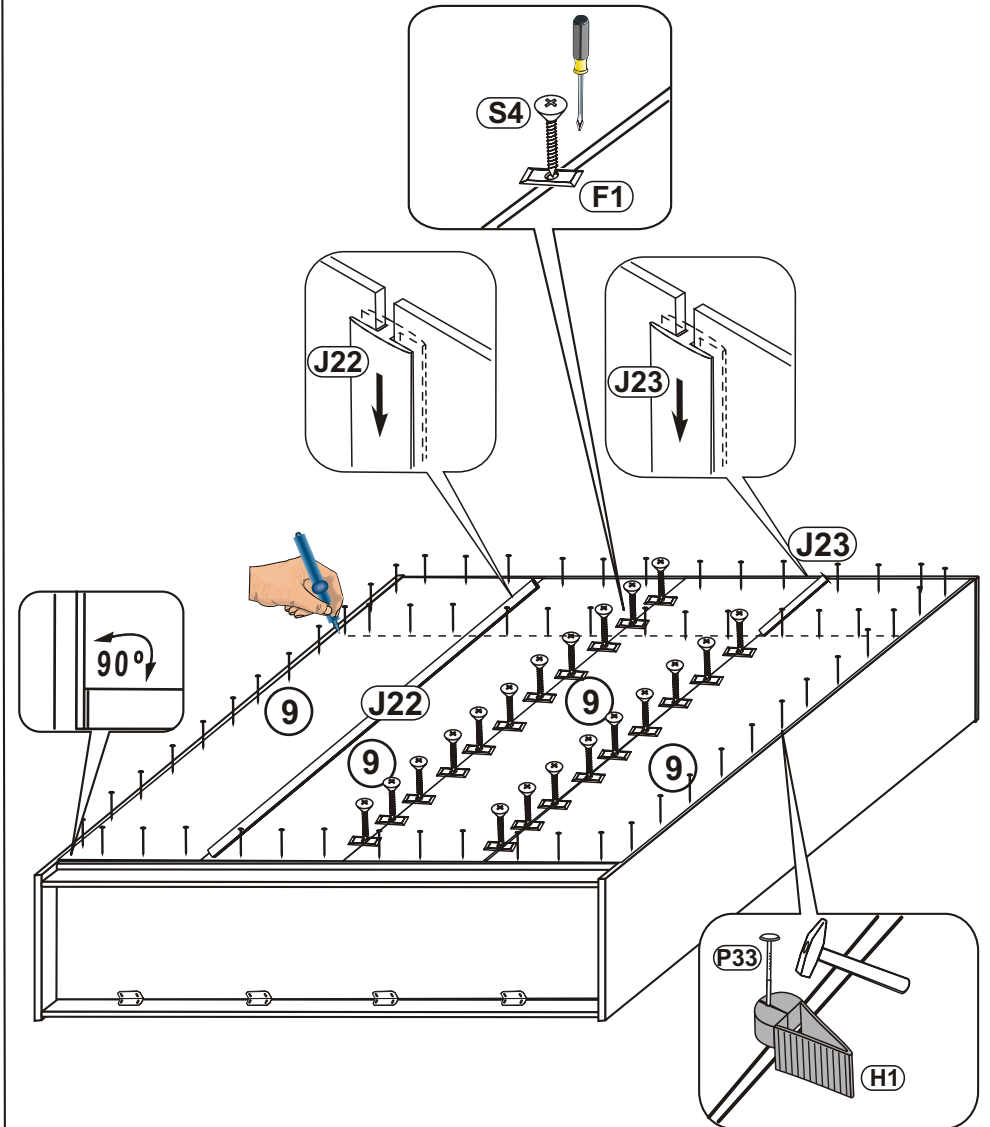
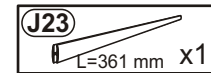
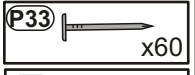
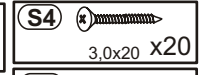
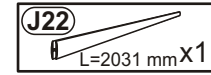

CLINT CLINT PLUS

P4--CT
P4--CP

5

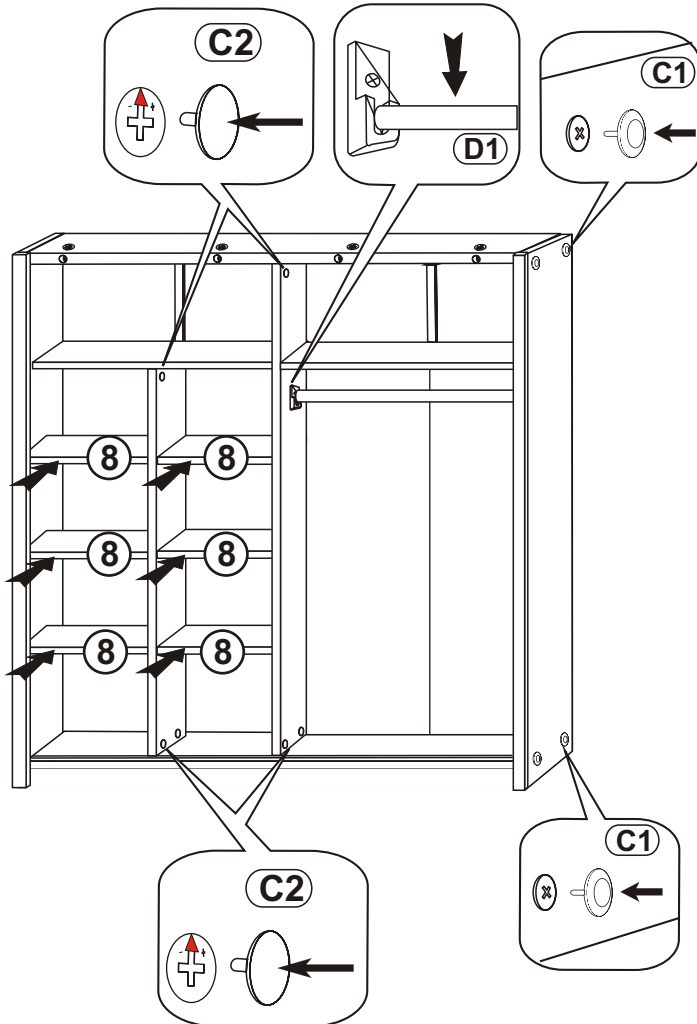
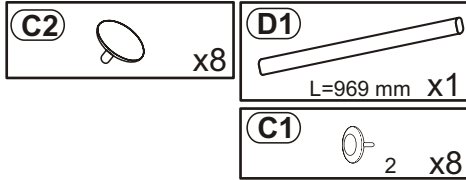

6

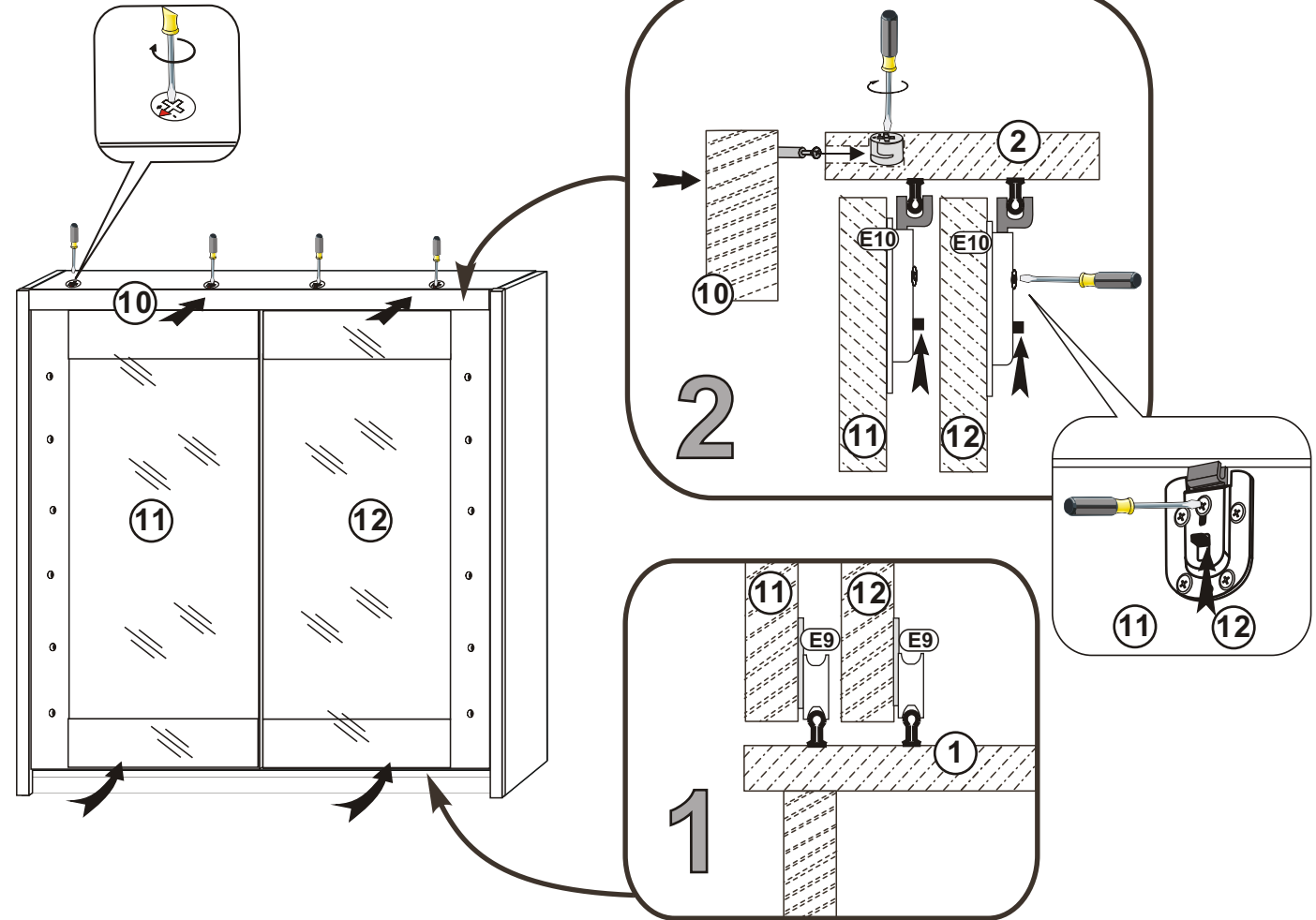

CLINT CLINT PLUS

P4--CT P4--CP

7

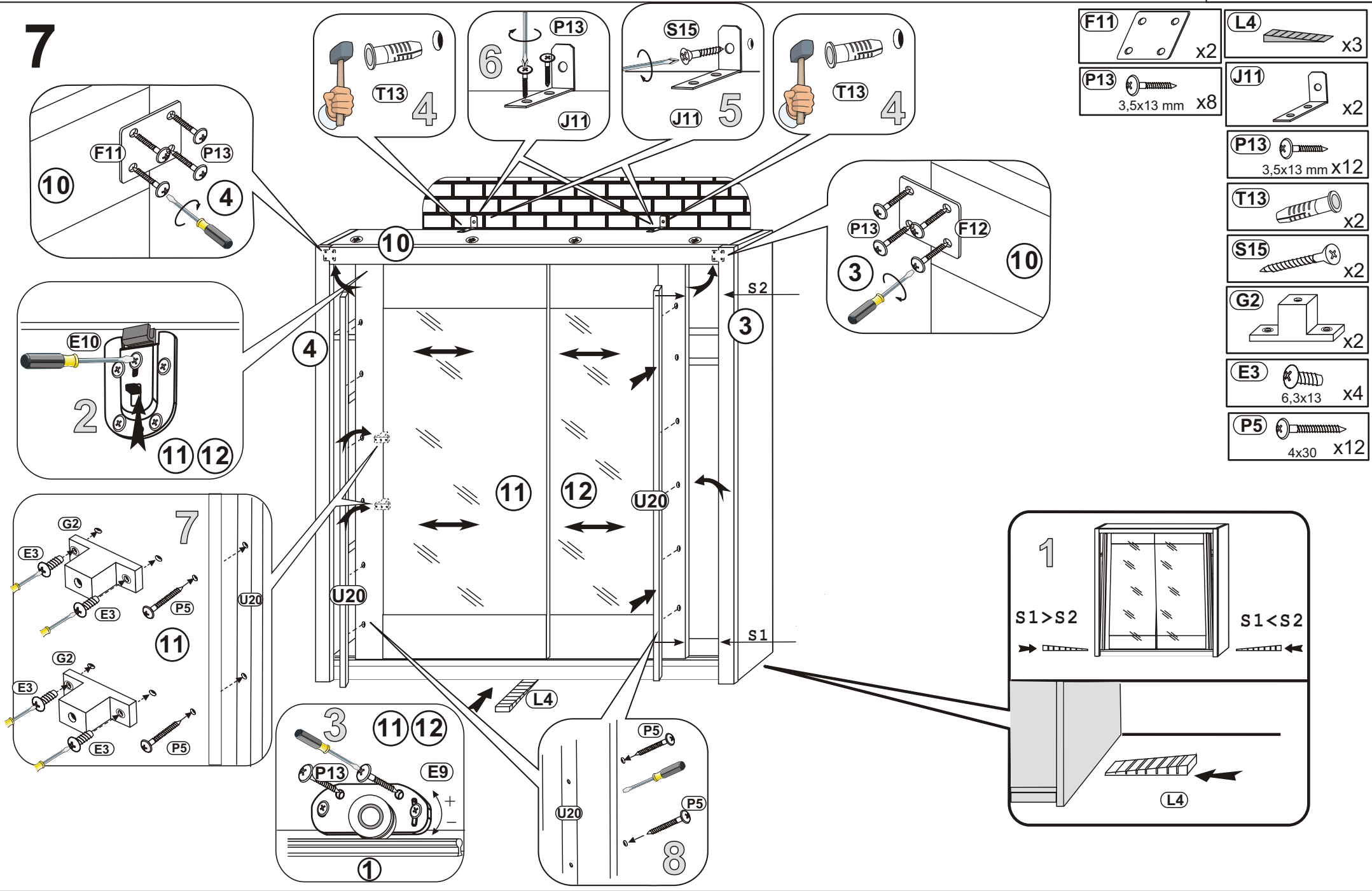

- F11** x2
- L4** x3
- P13** 3,5x13 mm X8
- J11** x2
- P13** 3,5x13 mm X12
- T13** x2
- S15** x2
- G2** x2
- E3** 6,3x13 x4
- P5** 4x30 x12