





1

T6  x12

C2  x12

M1  x12

T1  x12

B1  8x28mm x14

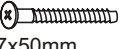
K1  Ø7x50mm x3

C1  2 x2

W3  x24

M6  x20

P16  Ø4,2x13mm x20

L1  x1

F1  x10

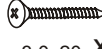
S4  3,0x20 x10

2

F7  x2

S2  Ø3,0x13mm x2

3

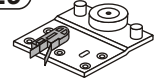
E9  x1

E1  Ø6,3x11mm x5

E11  x1

4

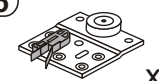
E5  x1

E1  Ø6,3x11mm x5

5

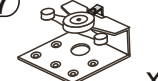
E7  x3

E1  Ø6,3x11mm x15

6

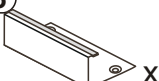
E8  x2

E1  Ø6,3x11mm x4

7

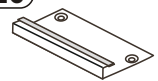
E6  x2

E1  Ø6,3x11mm x4

8

L4  x2

S3  Ø3,5x13mm x51

S2  Ø3,0x13mm x32

L5  L=2154 mm x2

L1  x1

9

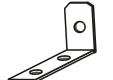
J11  x2

P13  Ø3,5x13 mm x4

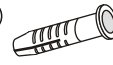
T13  8x40 x2

S15  x2

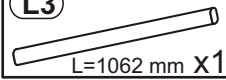
L3  L=1062 mm X1

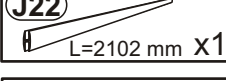
J22  L=2102 mm X1

J21  L=430 mm X1

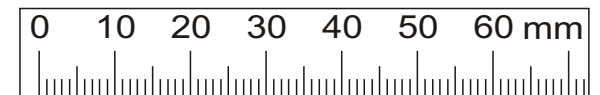

1

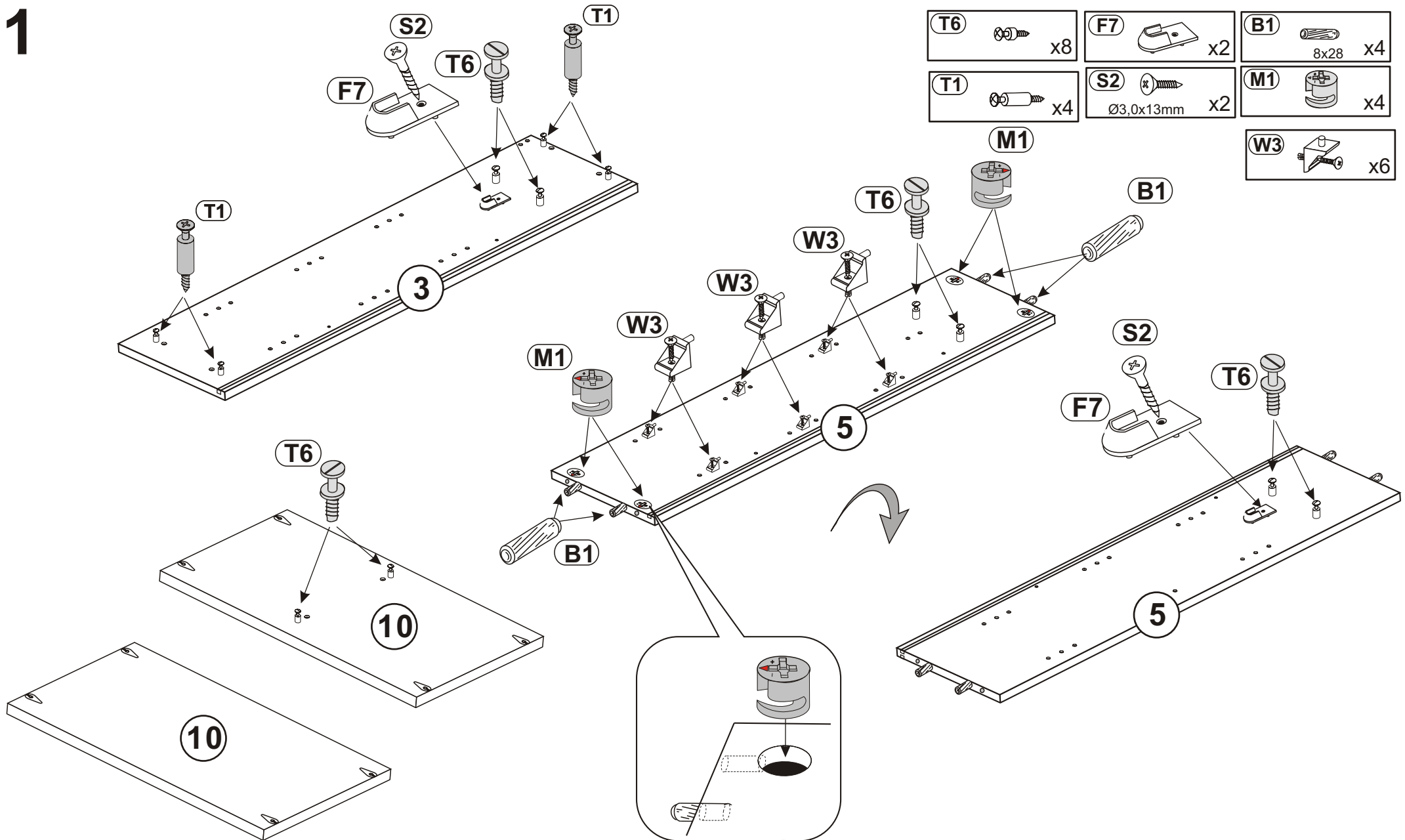

2

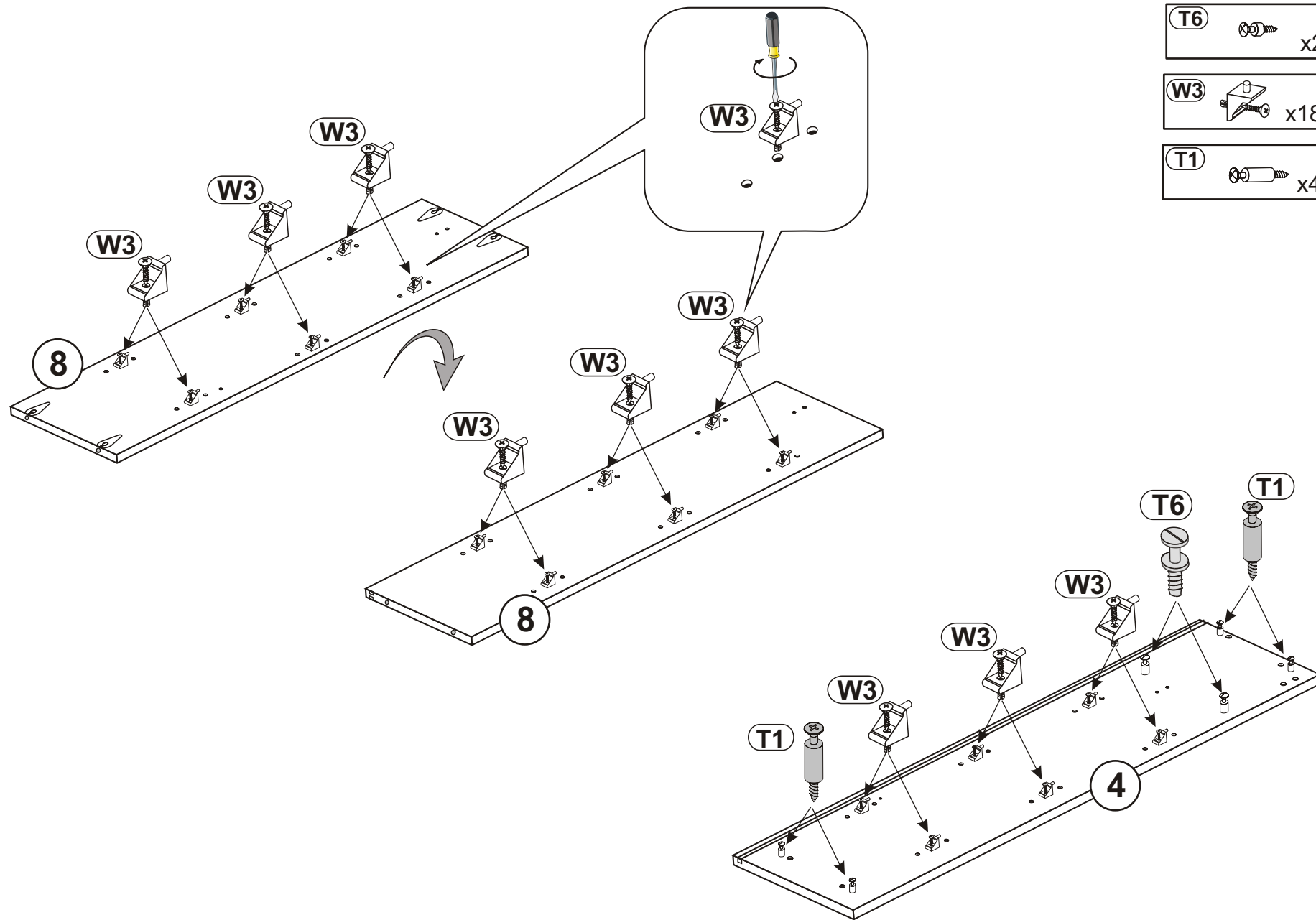

3

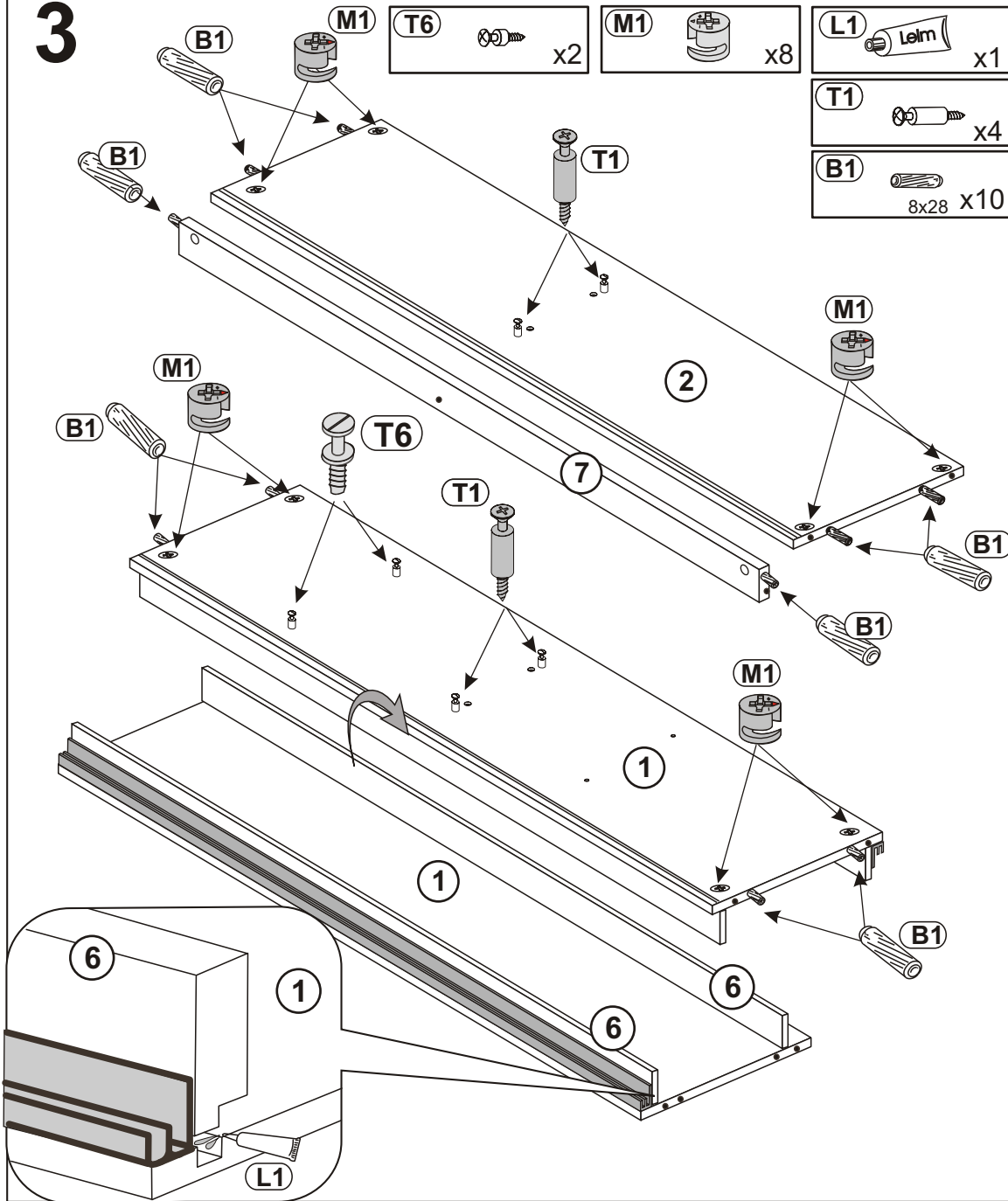

4

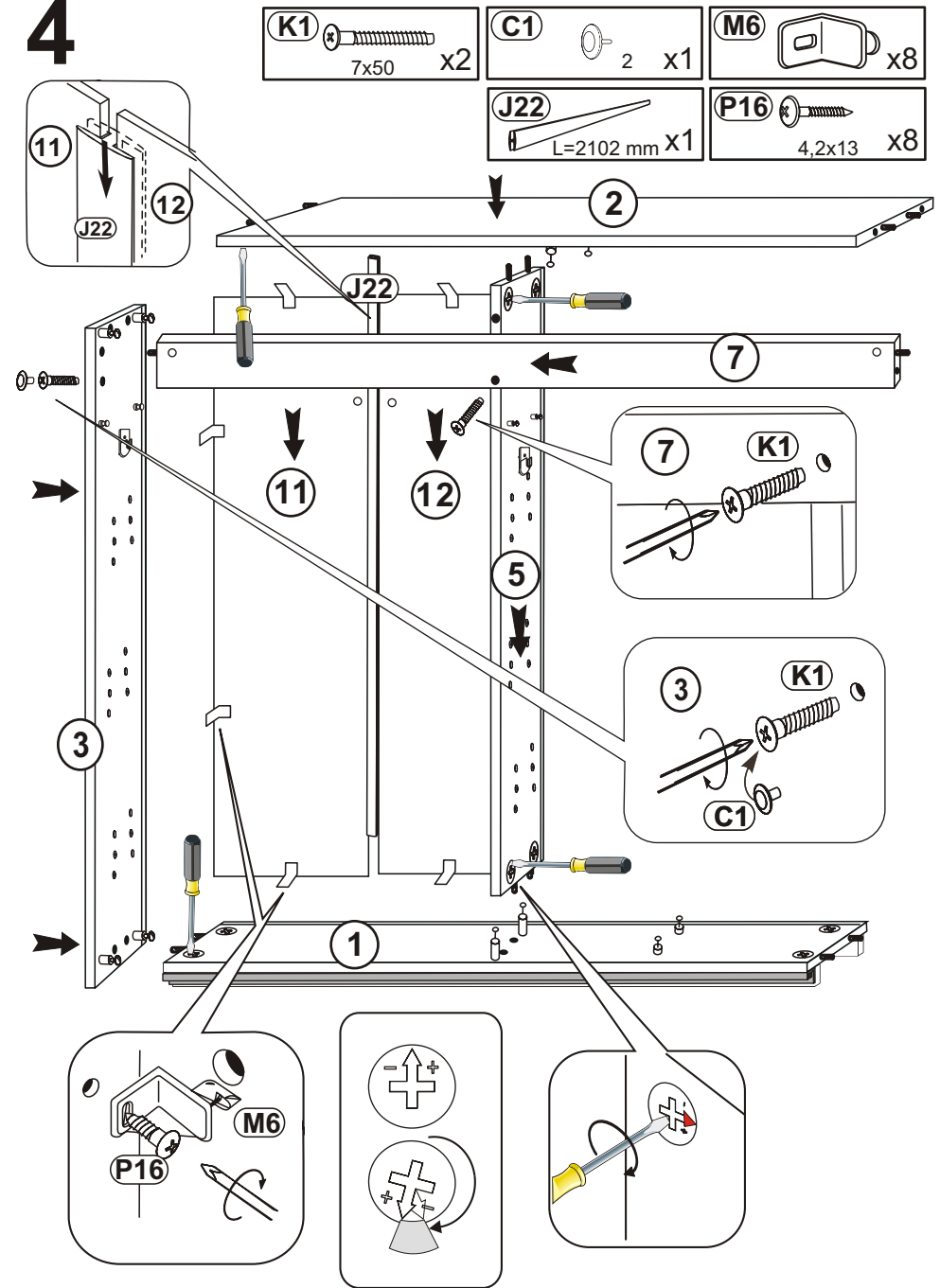

5

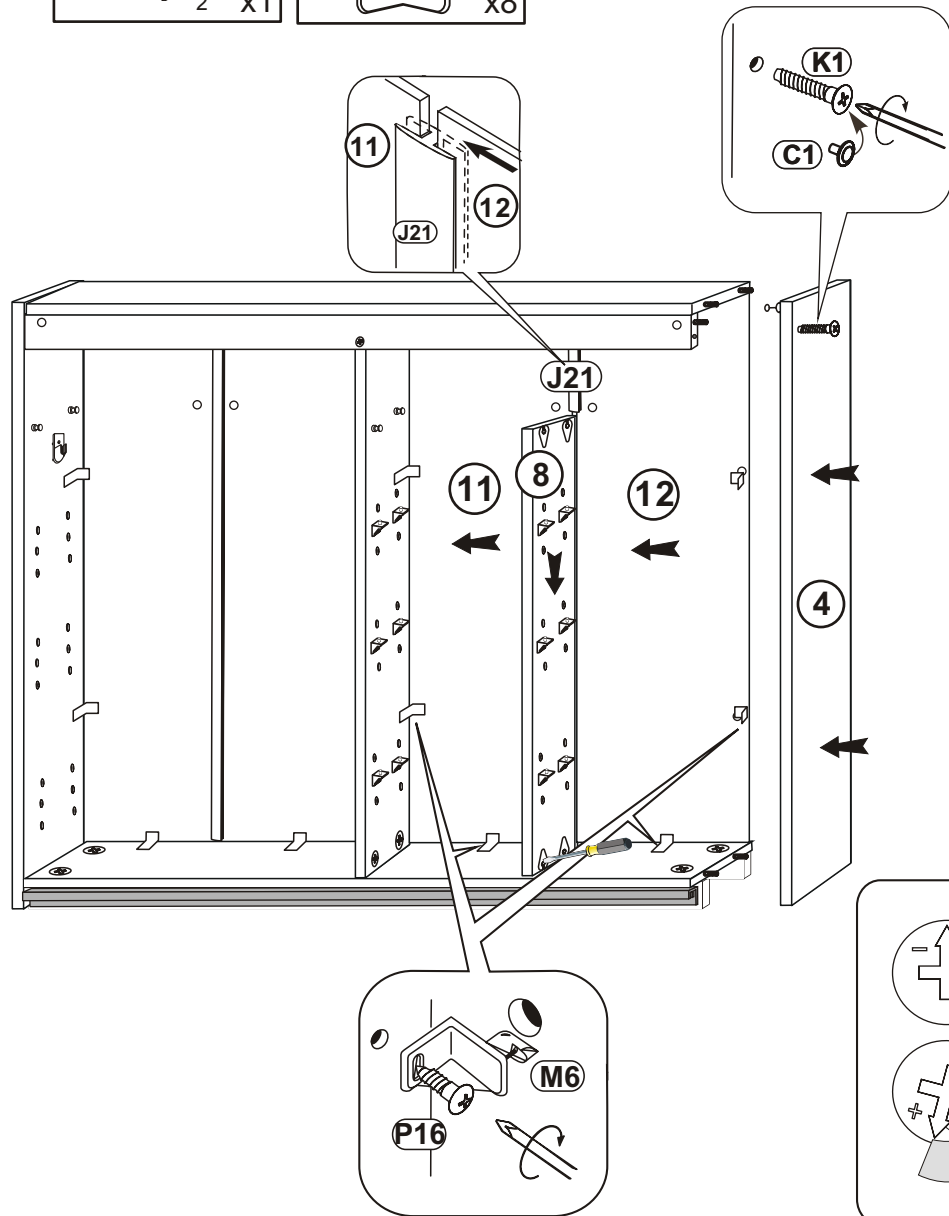
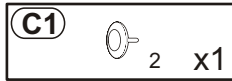
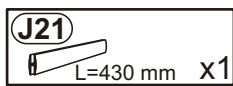
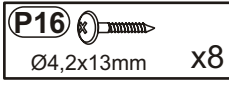
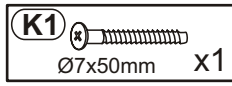

6

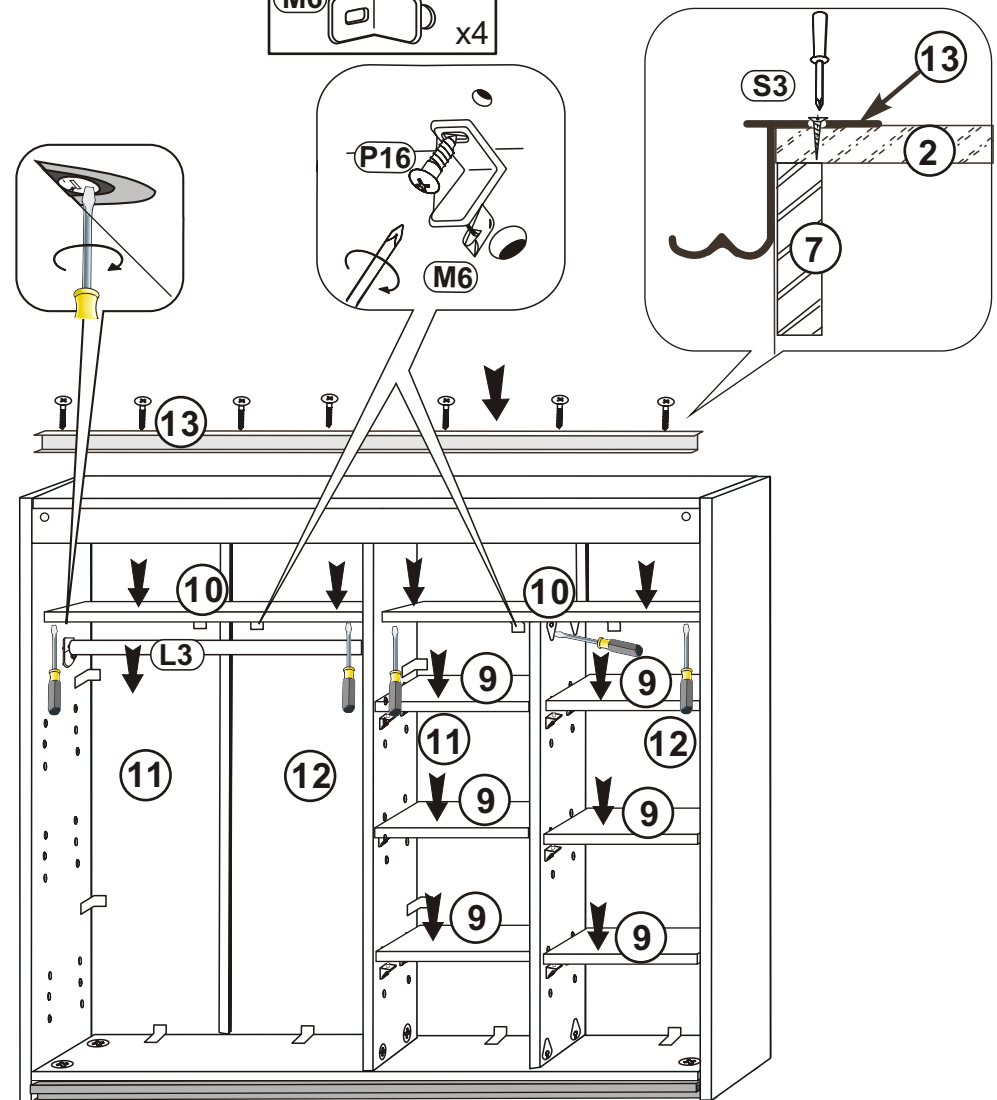
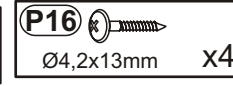
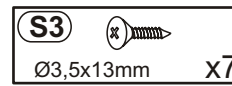

7

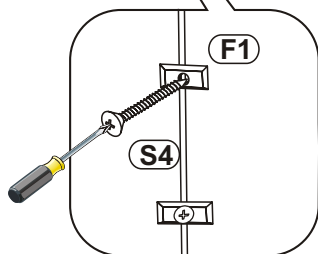
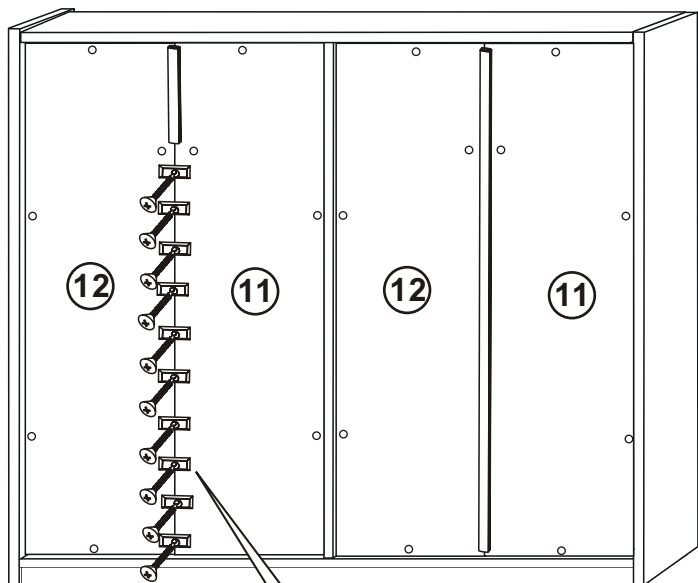
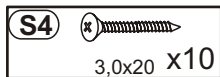
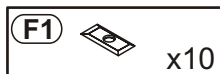

8

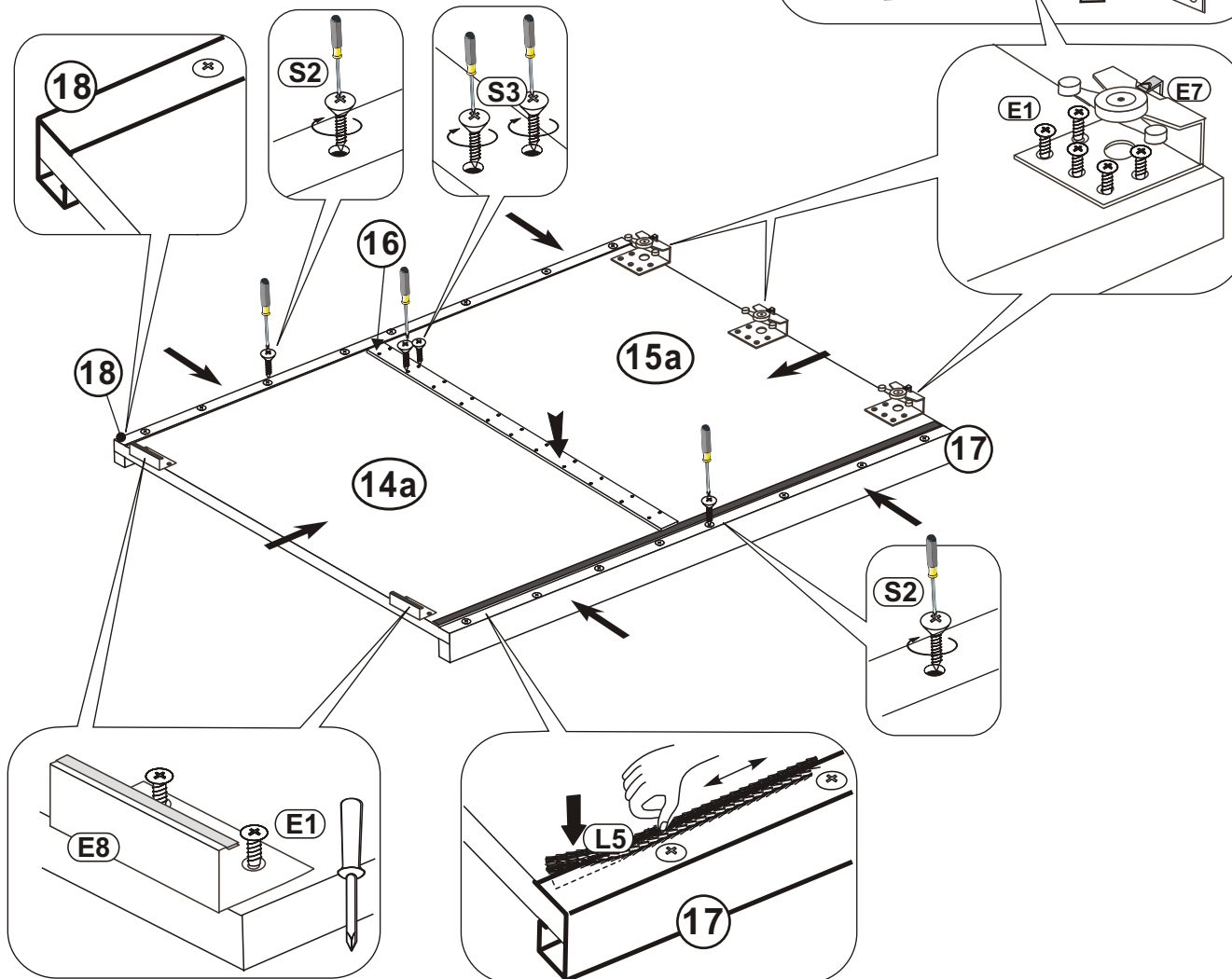
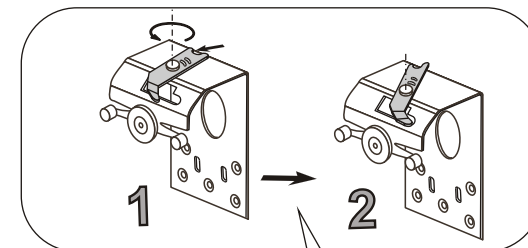
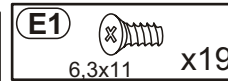
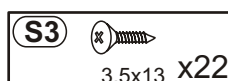
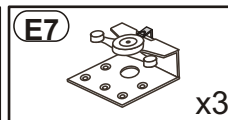
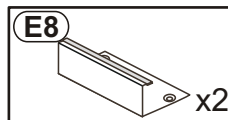

9

- | | | | |
|----------------------------|------------------------|---------------------------|------------------------|
| S3
3,5x13 x22 | E5
x1 | E9
x1 | E6
x2 |
| S2
Ø3,0x13mm x16 | E1
6,3x11 x5 | E1
6,3x11 x5 | E1
6,3x11 x4 |
| | E11
x1 | L5
L=2154 mm x1 | |

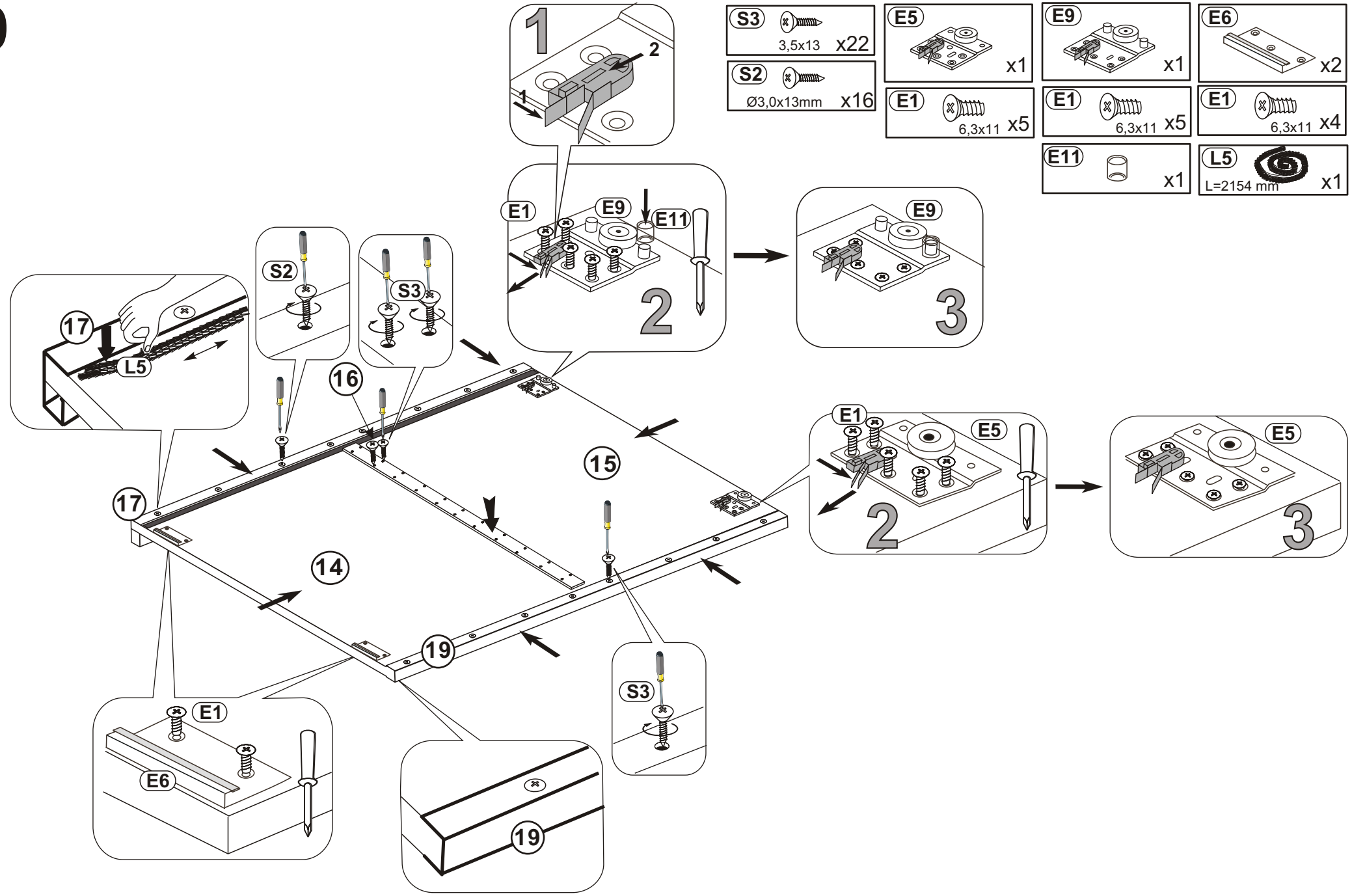

10

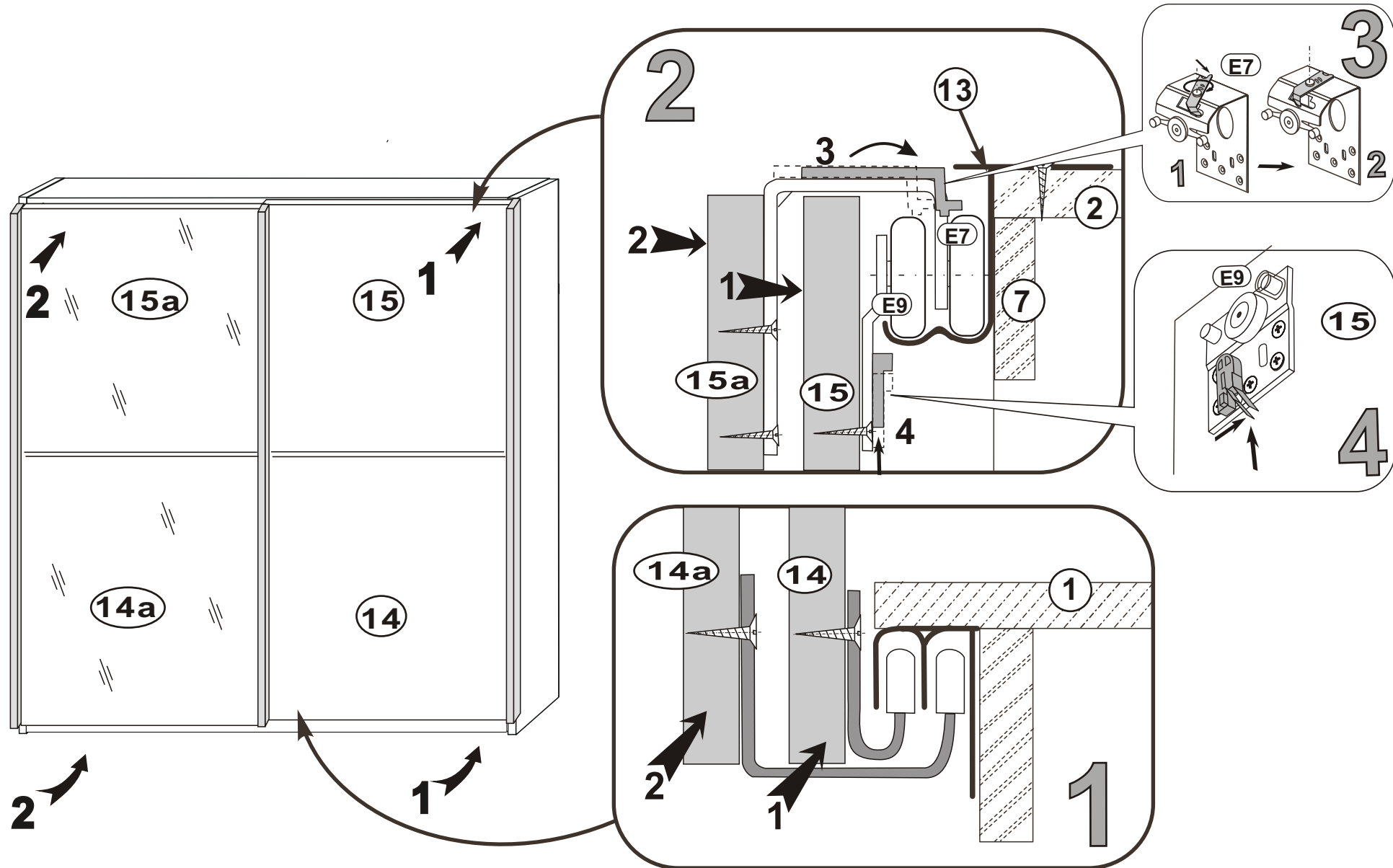

11

