











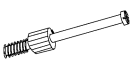



x 10  a		x 3  b		x 4  c	
x 4  d		x 4  e	x 4  f	x 5  g	x 2  h
x 1 (962 mm)  i		x 2  j		x 4  k	x 16 (3,5x16)  l
x 8 (4,8x13)  m	x 60  n	x 1  o	x 1  p	x 1 (1905 mm)  r	

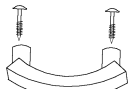

1 - FAZY MONTAŻU

A - OZNACZENIE ELEMENTÓW

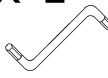
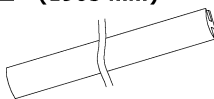
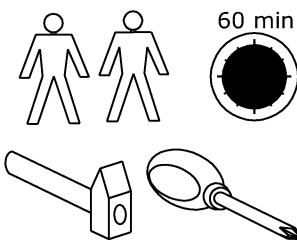
a - OZNACZENIE AKCESORIÓW

1

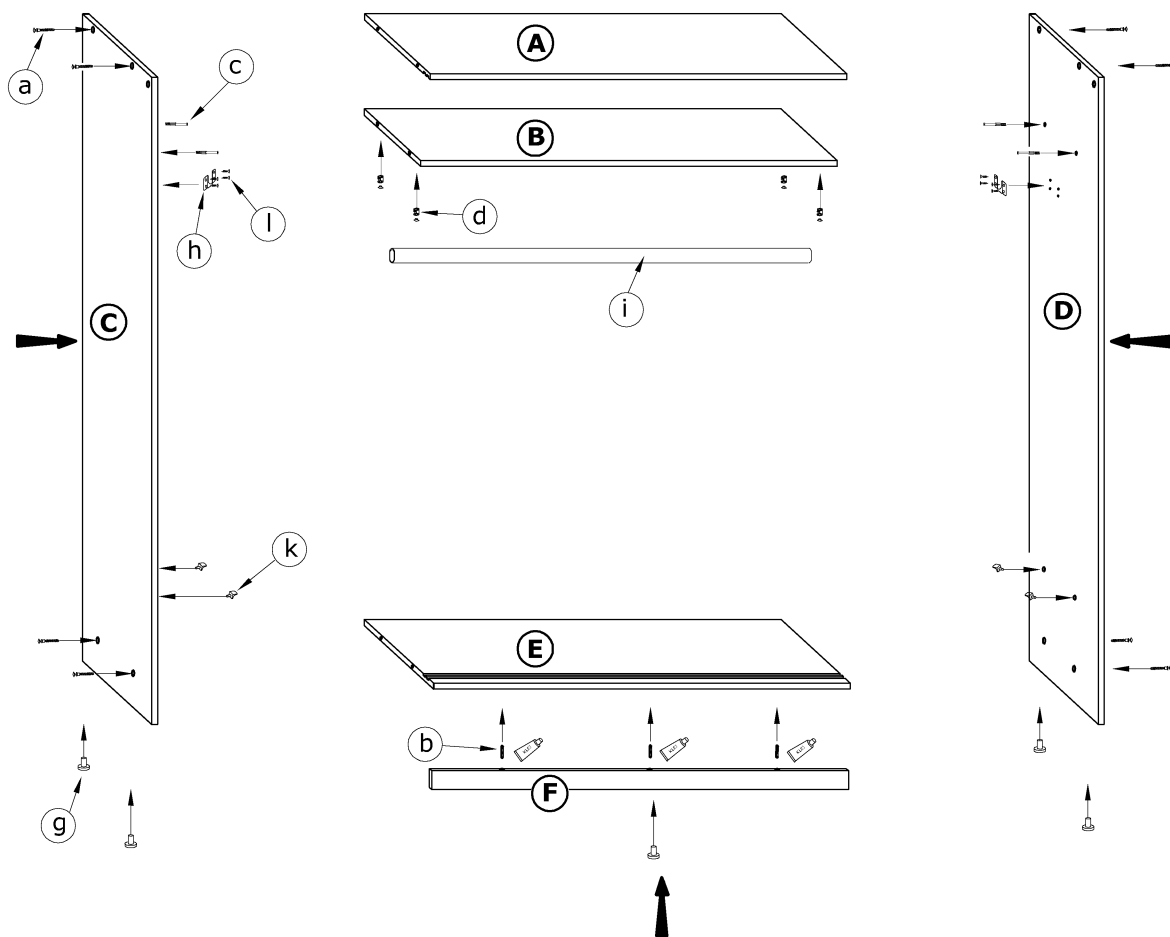

2

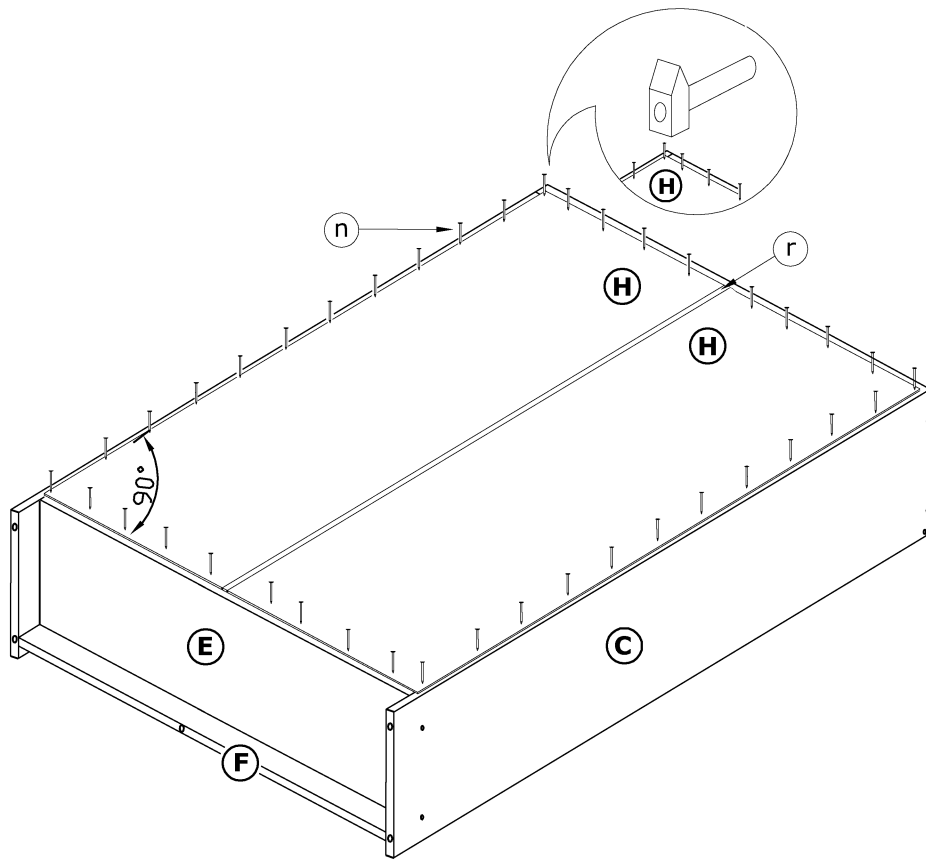

3

