

Demeyere

SAV
SPAREPARTS
KUNDERDIENST
POST VENTAS
SERVICE NA VERKOOP
SERVIZIO POST-VENDITA
SERVICO DEPOIS DE VENDA
SERWIS POGWARANCYJNY

400825 0

(FR) MEUBLES A FIXER AU MUR:

- FIXER LE MEUBLE AU MUR AVEC LES ATTACHES PREVUES A CET EFFET
- VERIFIER QUE LES VIS ET LES CHEVILLES UTILISEES SONT ADAPTEES AU SUPPORT

(ES) MUEBLES A FIJAR EN LA PARED:

- FIJAR EL MUEBLE EN LA PARED CON LAS GRAPAS PREVISTAS
- COMPROBAR QUE LOS TORNILLOS Y LAS CLAVIJAS UTILIZADAS SON ADAPTADAS AL SOPORTE

(PT) MOVEIS A FIXAR NA PAREDE:

- FIXAR O MOVEL NA PAREDE COM OS PRENDES PREVISTOS
- VERIFICAR QUE OS PARAFUSOS E AS CAVILHAS UTILIZADOS SAO ADAPTADOS OA SUPORTE

(EN) FURNITURES TO BE HOLD ON THE WALL:

- HOLD THE FURNITURE ON THE WALL WITH THE FASTENINGS PROVIDED FOR THIS PURPOSE
- CHECK THAT THE SCREW AND PEGS FIT WITH THE SUPPORT

(IT) MOBILI DA FISSARE AL MURO:

- FISSARE IL MOBILE AL MURO CON LE FLANGIE PREVISTE A TALE SCOPO
- VERIFICARE CHE LE VITI ED I PERNI USATI SIANO ADATTI A QUEL TIPO DI SUPPORTO

(PL) MEBEL PRZEZNACZONY DO ZAINSTALOWANIA NA ŚCIANIE:

- NALEŻY ZAMONTOWAĆ TEN MEBEL NA ŚCIANIE PRZEZNACZONYMI DO TEGO CELU UCHWYTAMI
- NALEŻY SPRAWDZIĆ CZY ŚRUBY I KOSZULKI SĄ ODPOWIEDNIEJ WIELKOŚCI W STOSUNKU DO UCHWYŃÓW

(DE) MOEBEL AN DER MAUER ZU BEFESTIGEN:

- BEFESTIGEN SIE DAS MOEBELSTUECK MIT DEN DAFUER VORGESEHENEN BEFESTIGUNGSHAKEN
- UEBERPRUEFEN SIE BITTE DASS DIE SCHRAUBEN UND DUEBEL MIT DEM MATERIAL DER MAUER UEBEREINSTIMMEN

(NL) MEUBELS DIE AAN DE MUUR GEFIXEERD MOETEN WORDEN:

- FIXEER HET MEUBEL AAN DE MUUR MET DE DAARVOOR BESTEMDE HAKEN
- VERFIEER OF DE GEBRUIKTE SCHROEVEN BIJ DE BEVESTIGINGSHAAK HOREN

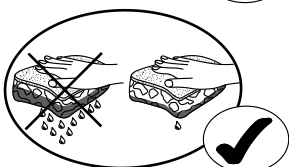
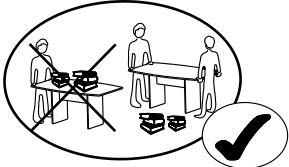
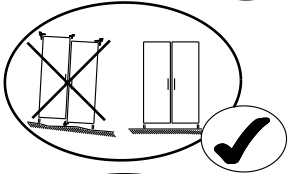
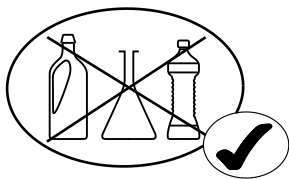

2H 00MN

**(FR) SECURITE**

RESPECTER LES INSTRUCTIONS DE MONTAGE DECRITES DANS LA NOTICE.

(EN) CAUTION

FOLLOW CAREFULLY THE ASSEMBLING INSTRUCTIONS DESCRIBED IN THE DIRECTIONS.

(DE) SICHERHEITSVORSCHRIFTEN

BEACHTEN SIE BITTE UNBEDINGT DIE ANGEGEBENEN AUFBAUVORSCHRIFTEN.

(ES) SEGURIDAD

RESPECTAR LAS INSTRUCCIONES DE MONTAJE DESCRIBIDAS EN EL FOLLETO.

(NL) VEILIGHEID

DE IN DE GEBRUIKSAANWIJZING BESCHREVEN INSTRUCTIES RESPECTEREN.

(IT) SICUREZZA

RISPETTARE LE INSTRUZIONI DI MONTAGGIO DESCRITTE NEEL'AVVERTENZA.

(PT) SEGURANCA

RESPEITAR AS INSTURAÇOS DE MONTAGEM DESCREVEDAS NA INSTRUÇÕES DE USO.

(PL) UWAGA

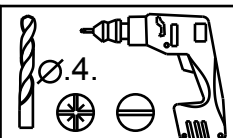
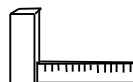
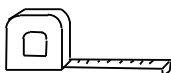
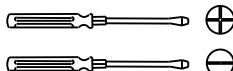
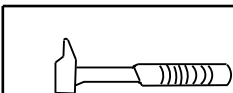

PROSZĘ PRZESTRZEGĄĆ INSTRUKCJI MONTÁZU.

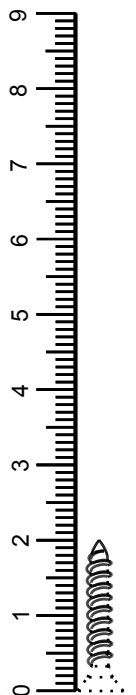
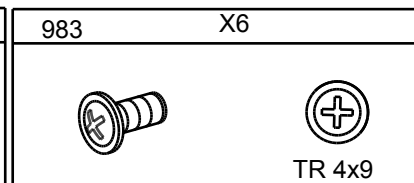
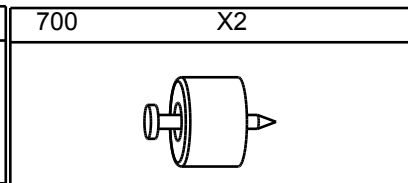
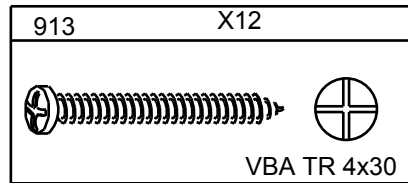
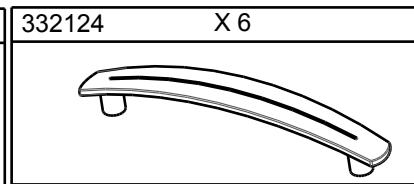
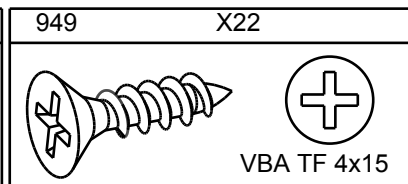
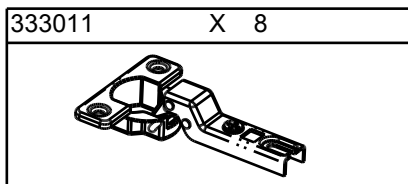
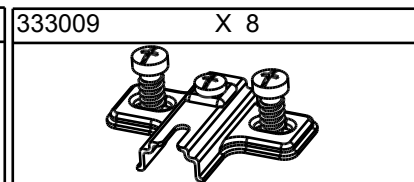
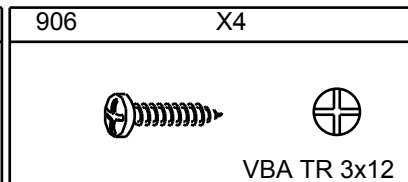
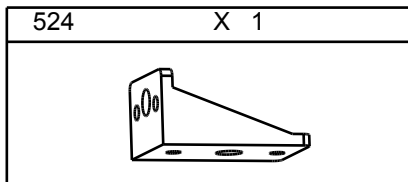
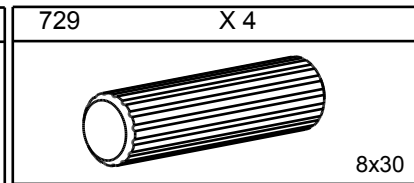
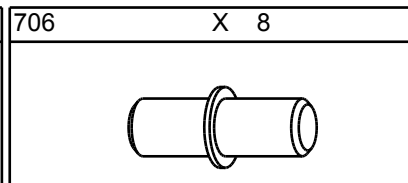
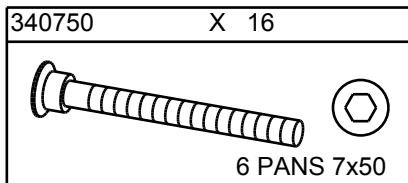
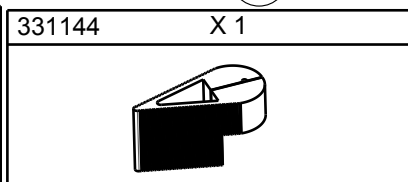
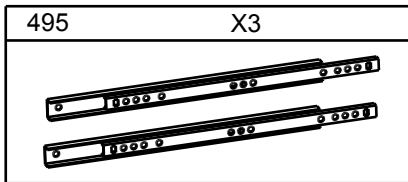
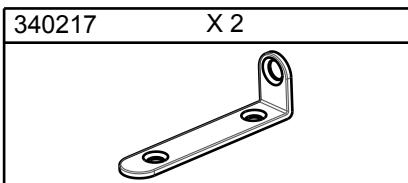
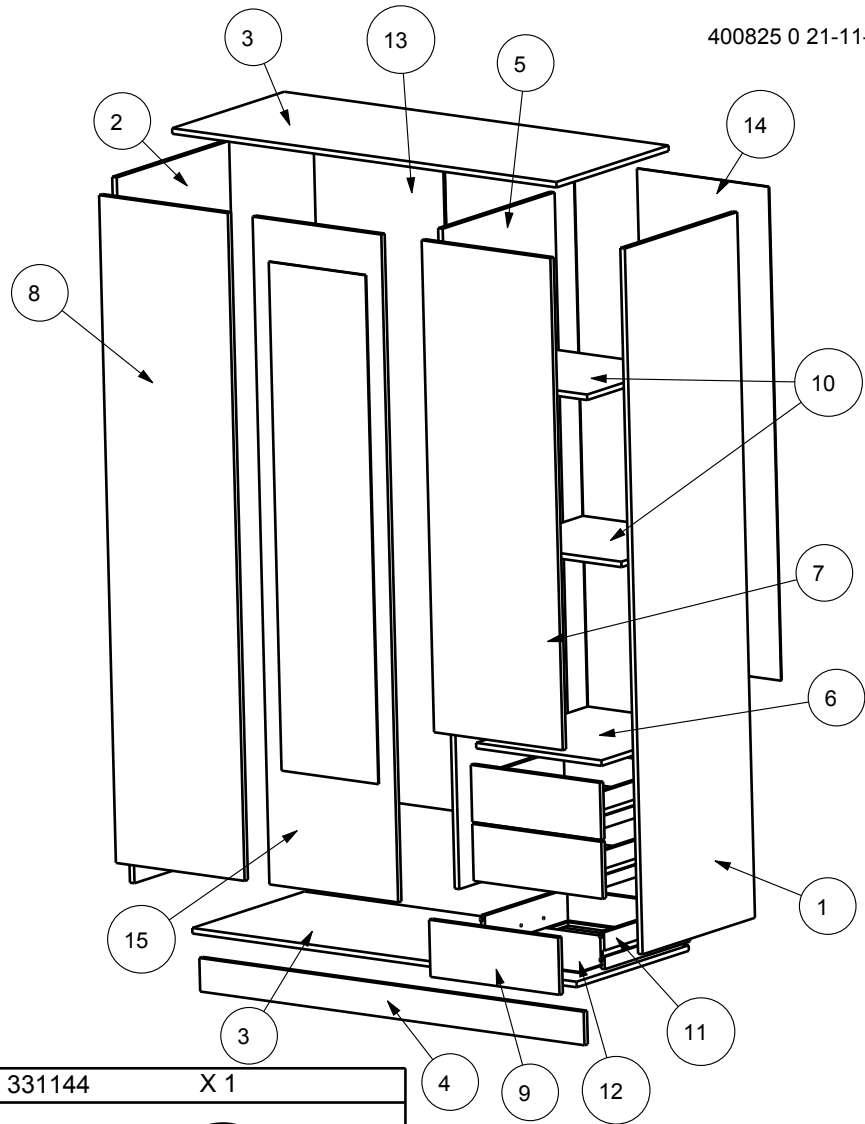

REP	DIM	QTE
1	1915 x 501	1
2	1915 x 501	1
3	1263 x 500	2
4	1263 x 91	1
5	1792 x 499	1
6	412 x 498	1
7	1335 x 423	1
8	1812 x 423	1
9	424 x 155	3
10	412 x 388	2
11	380 x 404	3
12	389 x 378	3
13	1819 x 856	1
14	1340 x 433	1
15	1812 x 423	1



935 X2



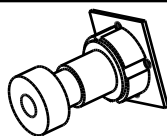

VBA SPAX TF 3x12

350051 X 1



928 X12



EURO TF 6,3x9

604757 X2

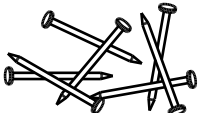

x30

929 X 8



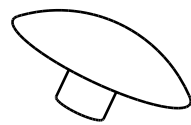

SPAX 3x16

1107 X 12

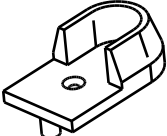

310040 X 2



17983 X 1

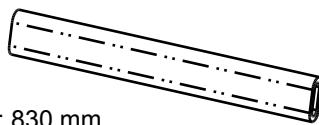

Lg : 830 mm

434 X 1

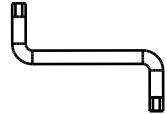

732 X1

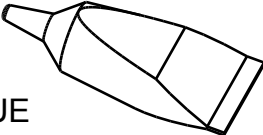

GLUE

1625 X 4



1

732 X1

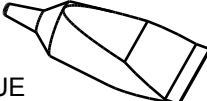



GLUE

332124 X 3



913 X6

VBA TR 4x30

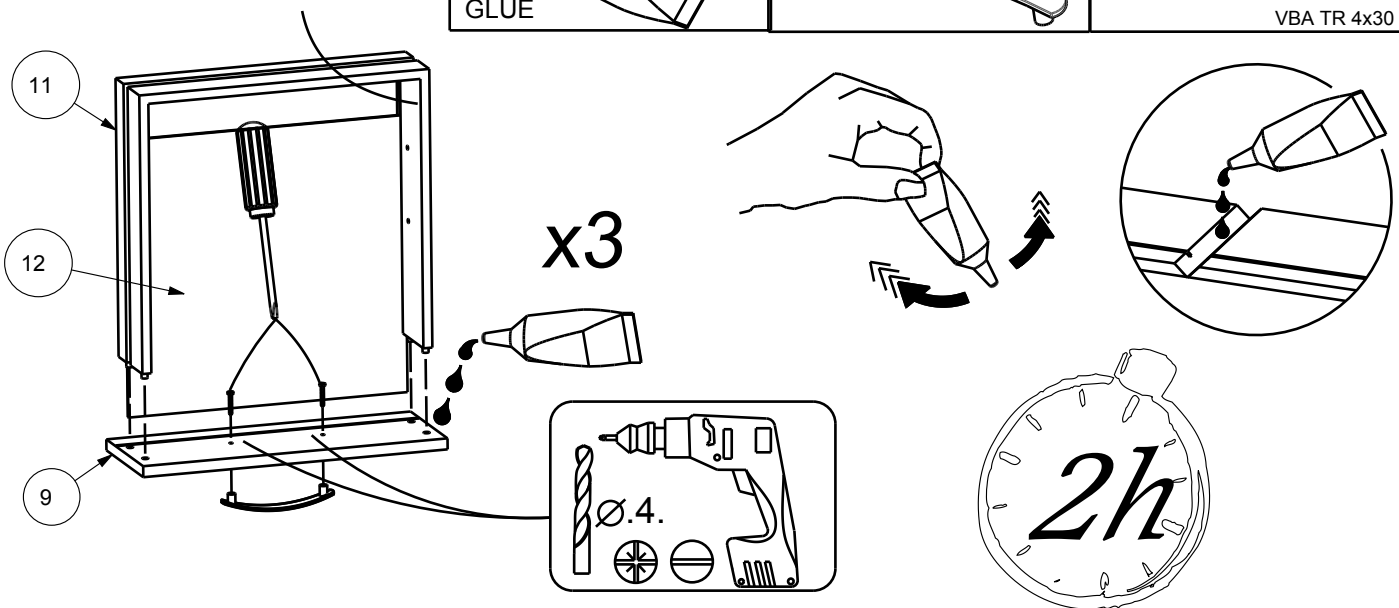

2



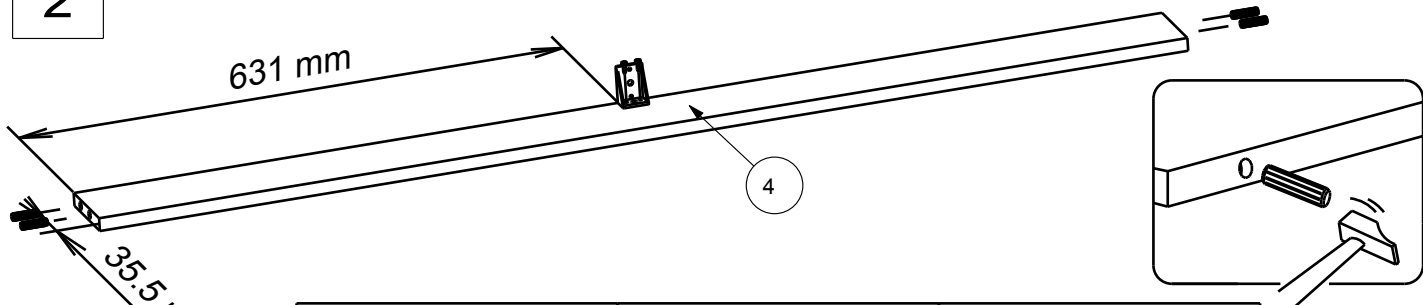

729 X 4



8x30

906 X 2



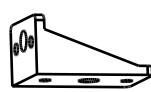

VBA TR 3x12

524 X 1

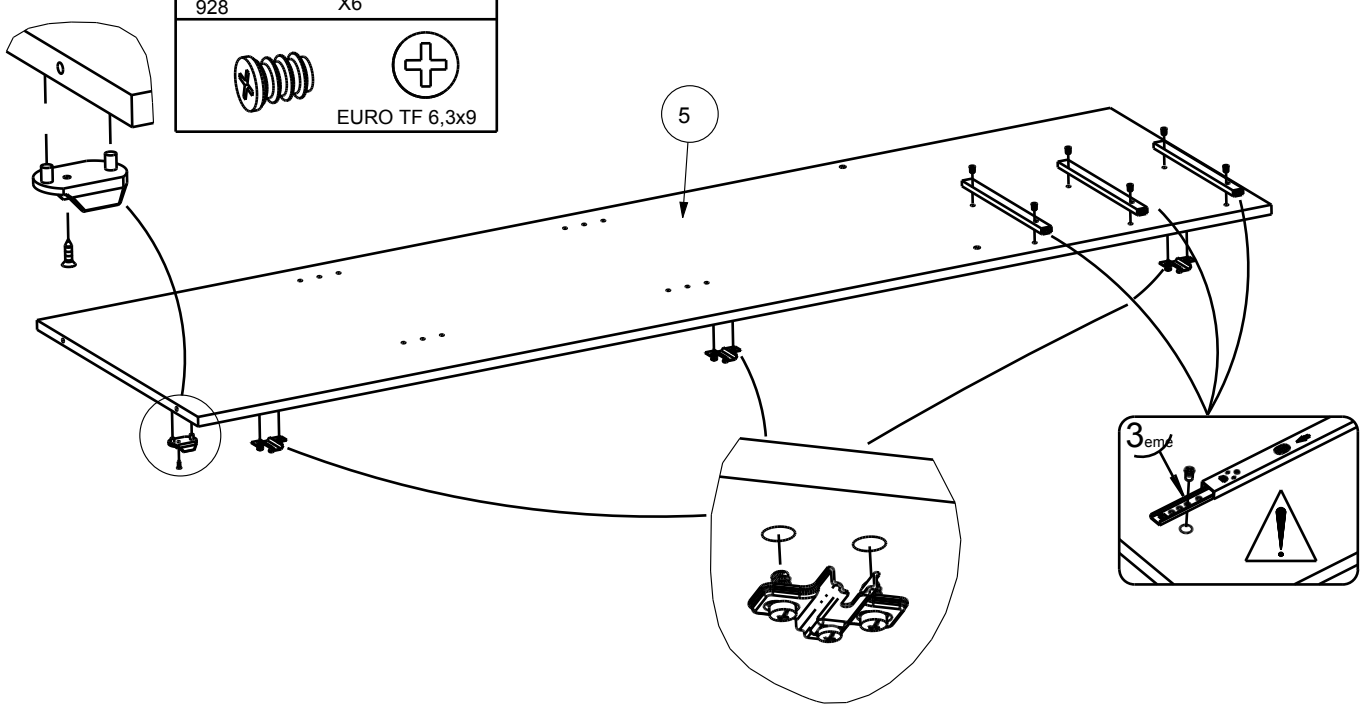

3	333009 X 3	310040 X 1	935 X1	495 X3
			 VBA SPAX TF 3x12	
	928 X6			
	 EURO TF 6,3x9			



4	340750 X 4
	 6 PANS 7x50

434 X1

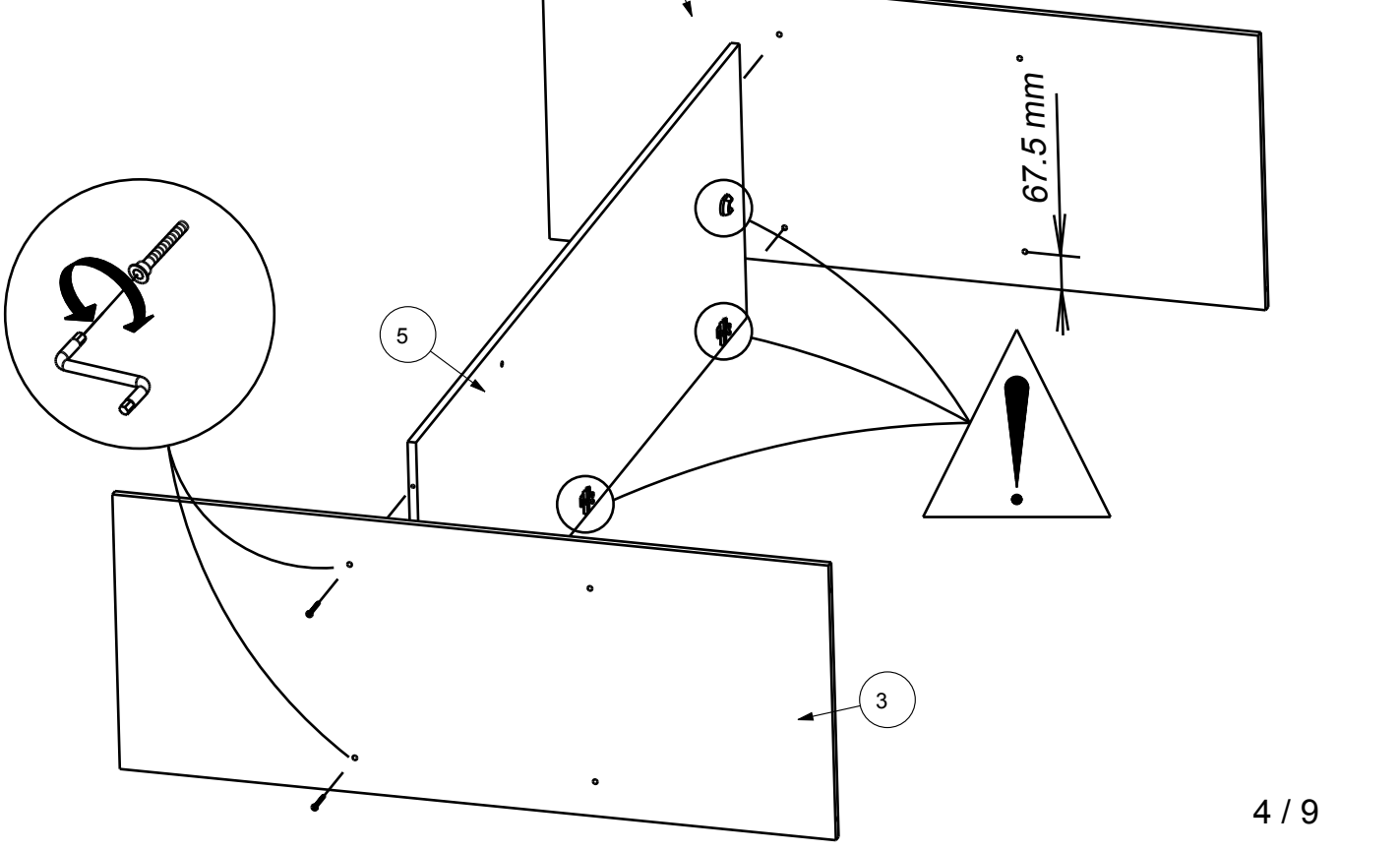

5

495	X3	333009	X 2	928	X6
				EURO TF 6,3x9	

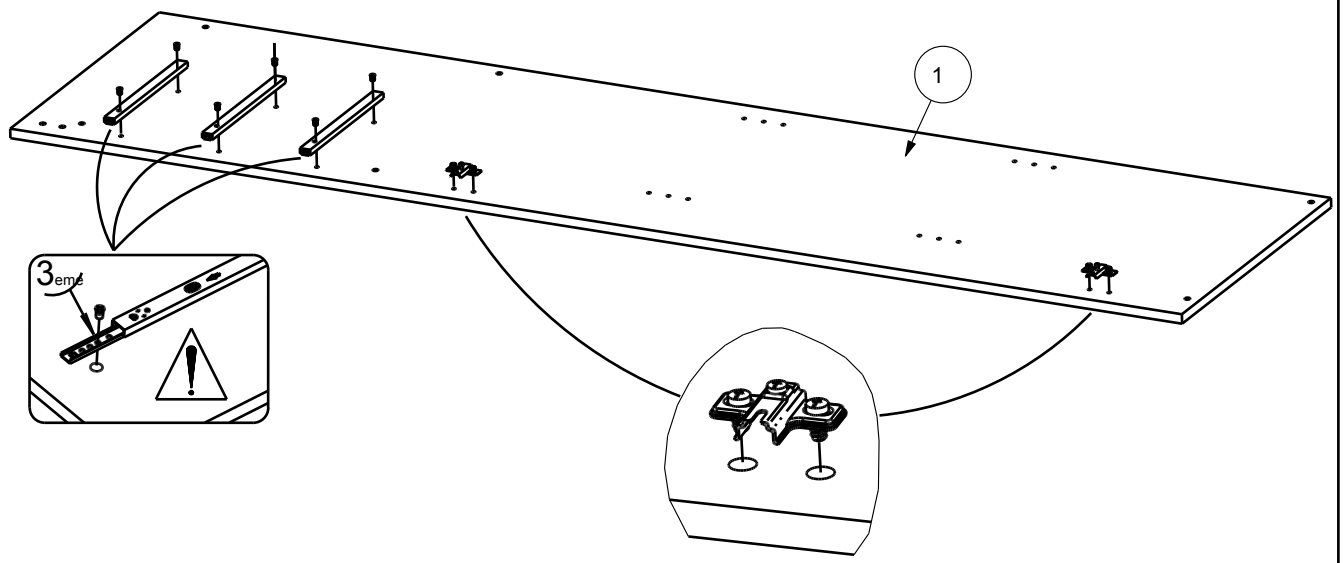



6

340750	X 8
6 PANS 7x50	

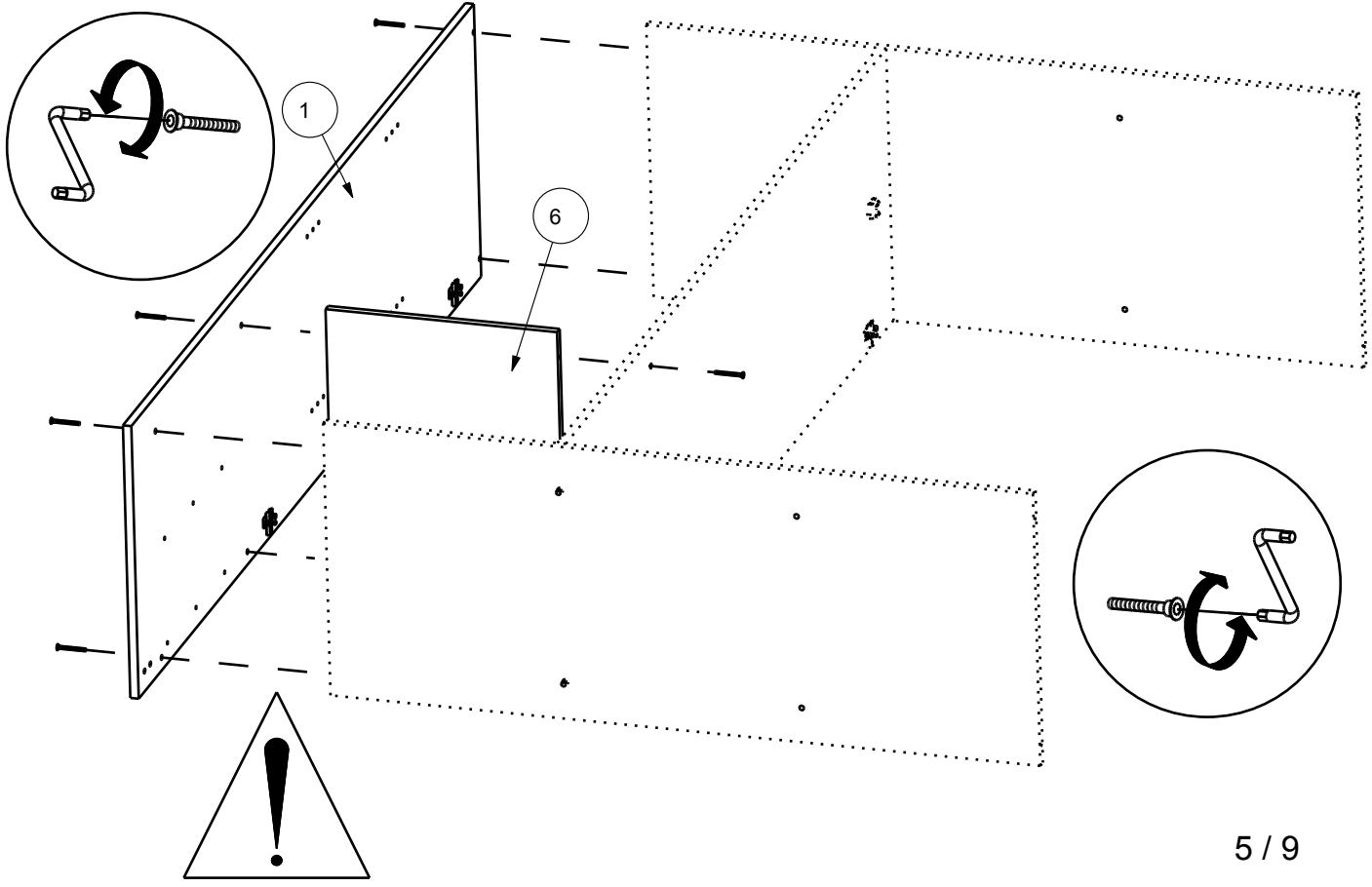
434	X1



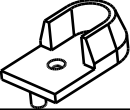

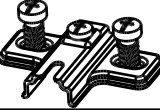
7

310040	X 1	935	X 1	333009	X 3
		 VBA SPAX TF 3x12			

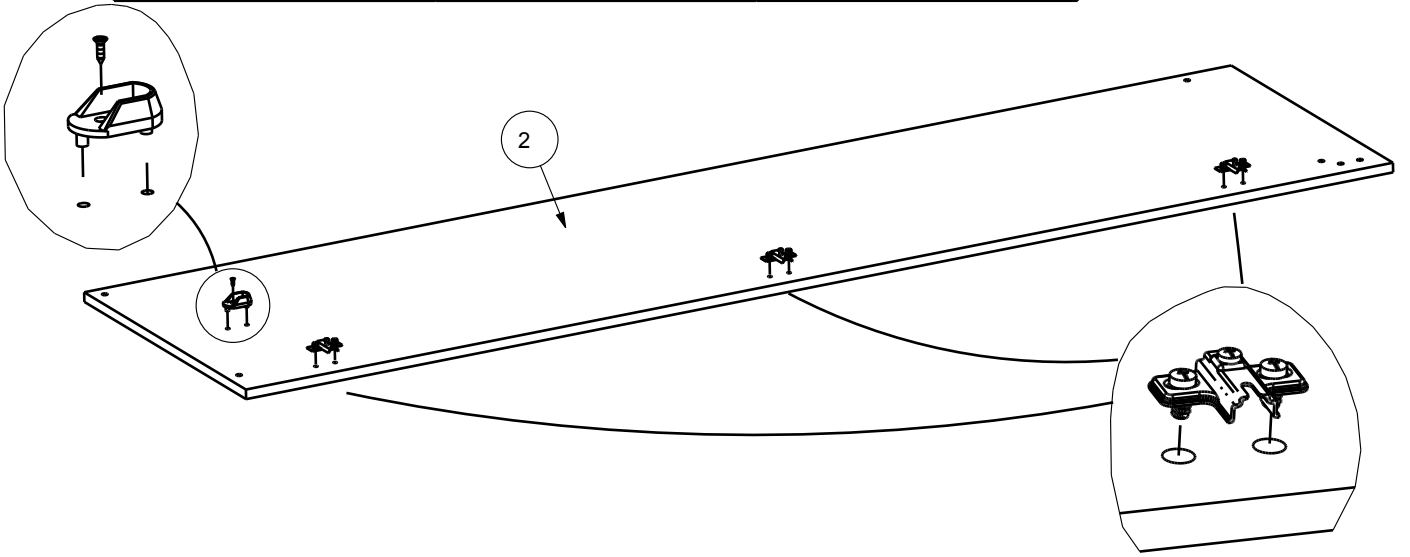
400825 0 21-11-11

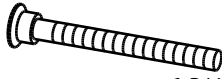

8

340750	X 4
	
6 PANS 7x50	

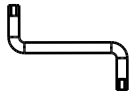
434	X1
	

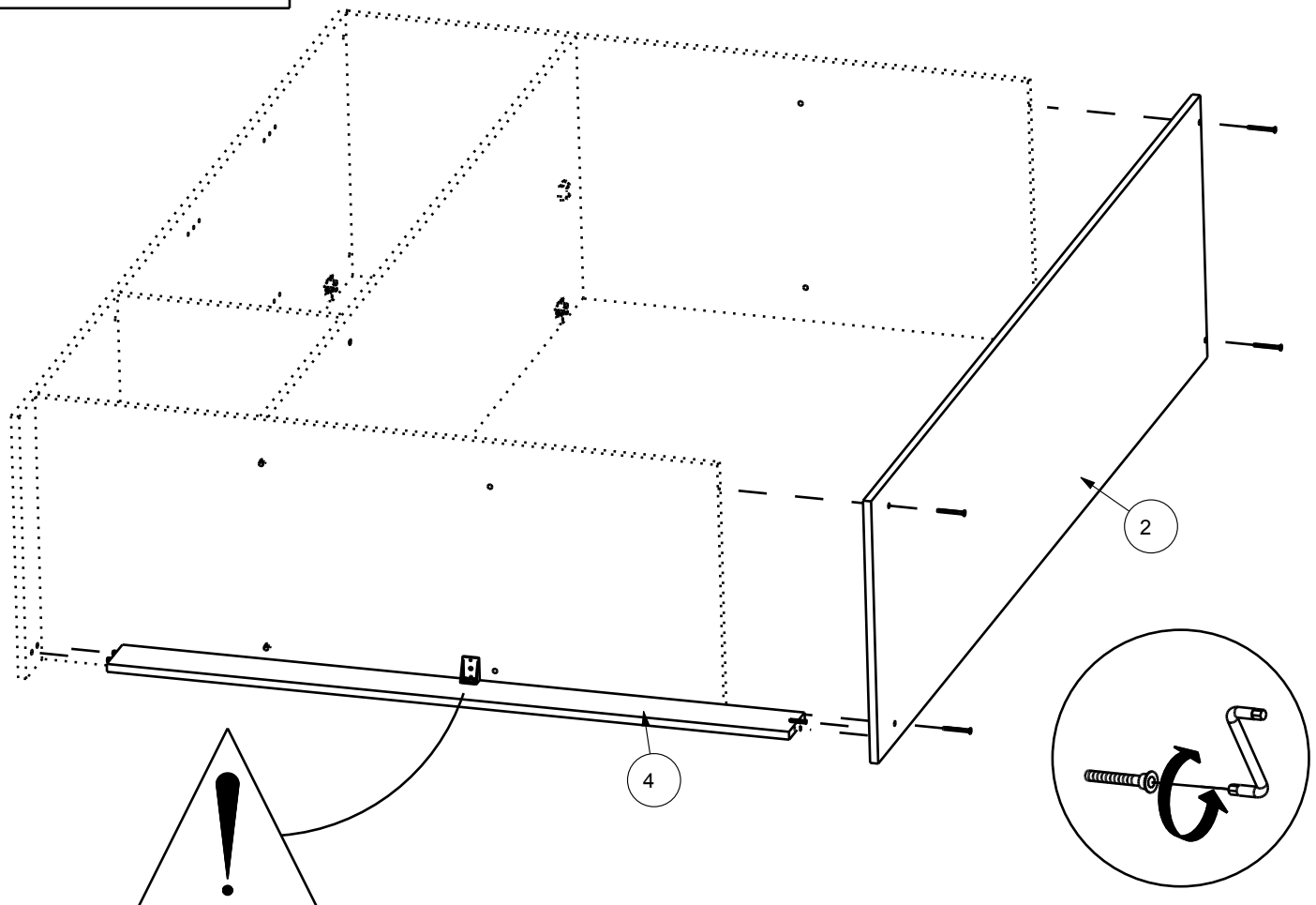

9

929 X 8



SPAX 3x16

331144 X 1



604757 X 2

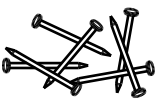

x30

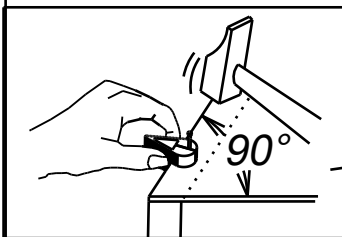

350051 X 1

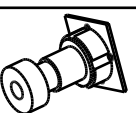

949 X 4



VBA TF 4x15

906 X 2



VBA TR 3x12

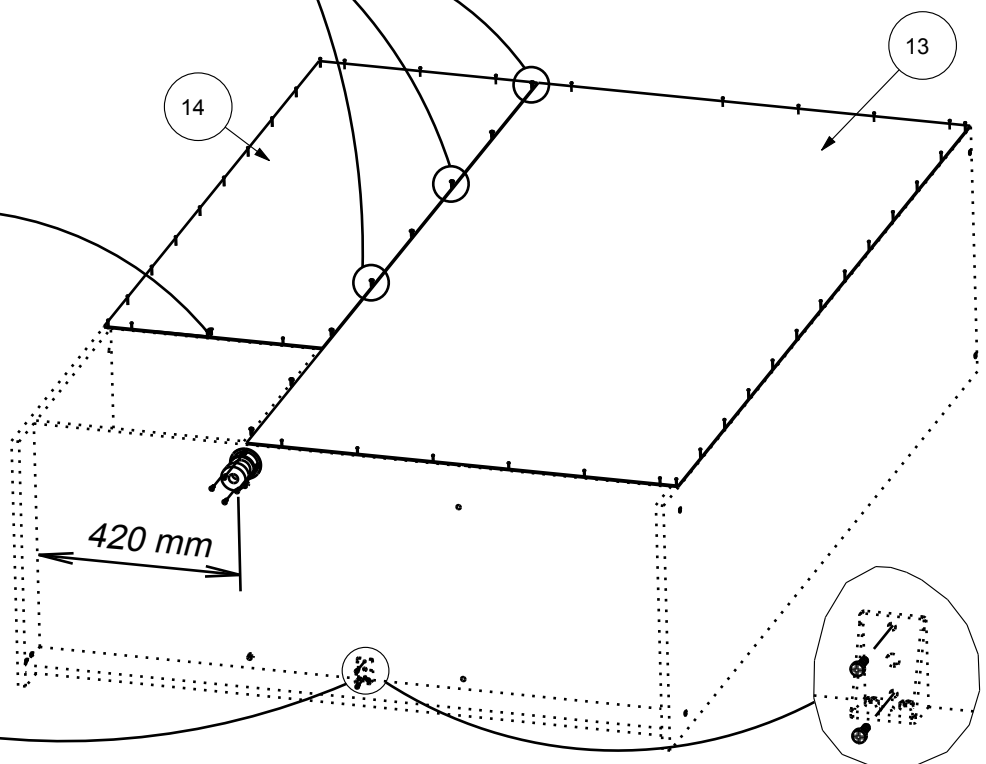

10

9mm

32.5 mm

17983 X 1

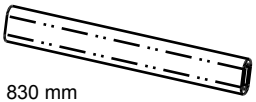

Lg : 830 mm

706 X 8

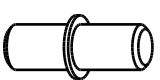

700 X 2

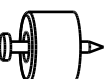

1625 X 4

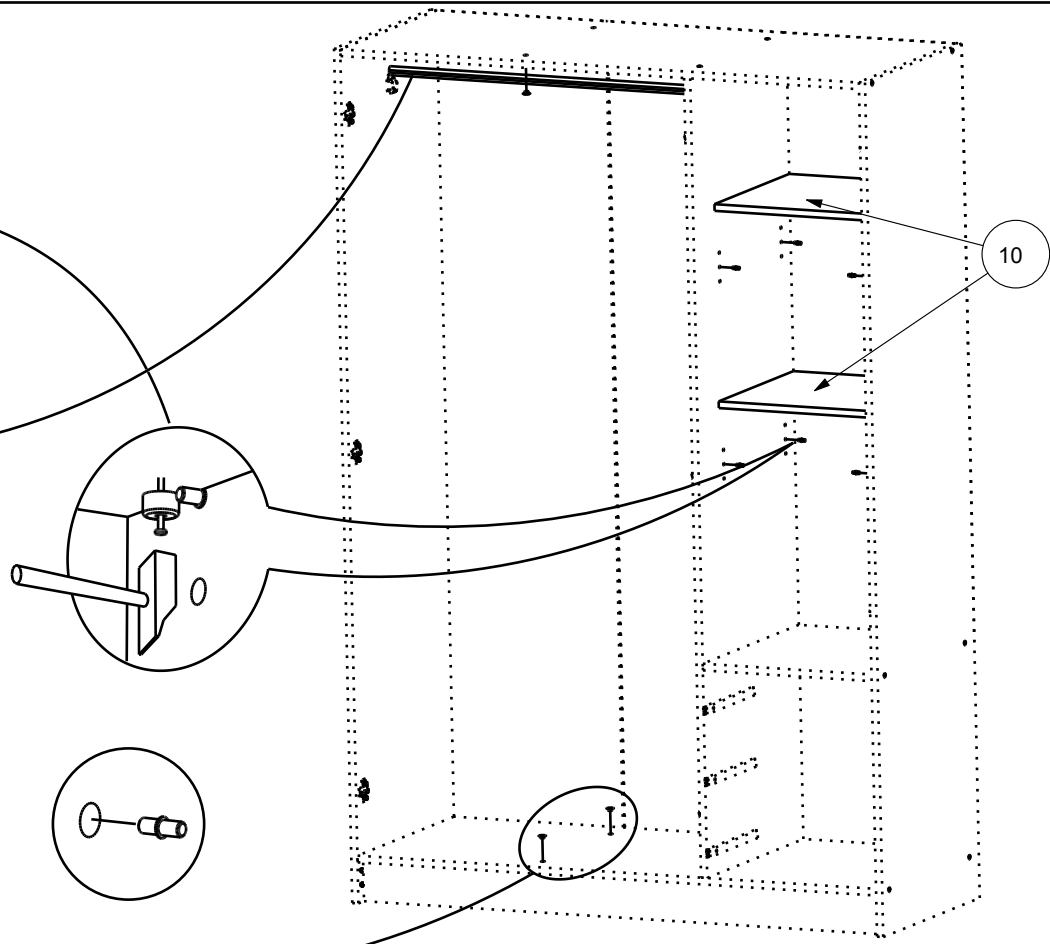

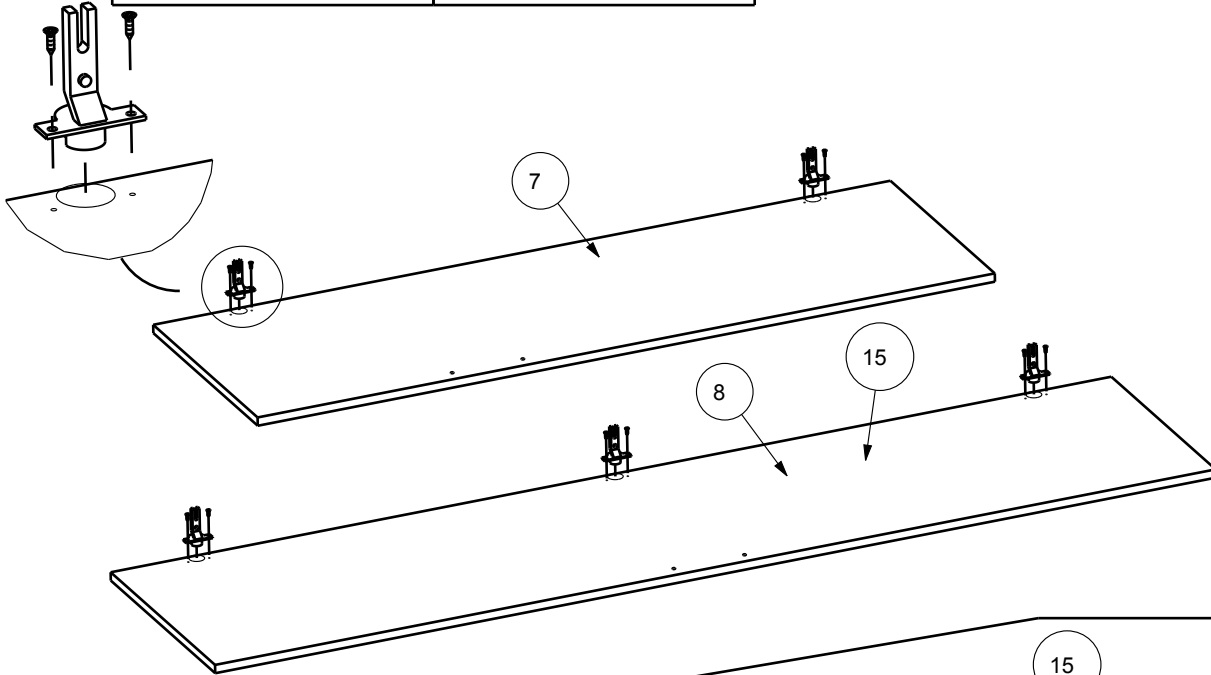

11

333011	X 8	949	X 16

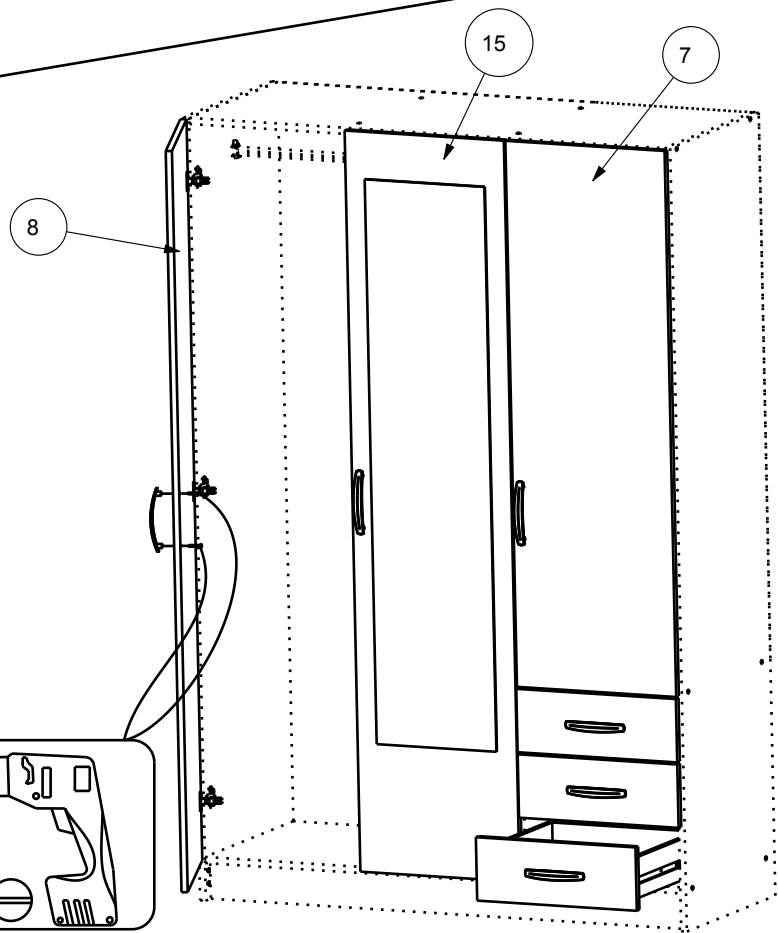
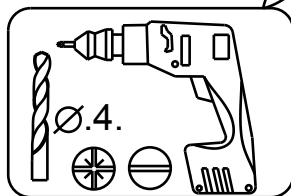
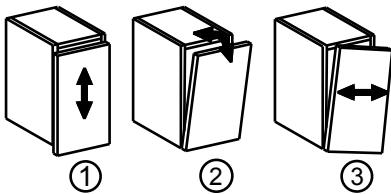
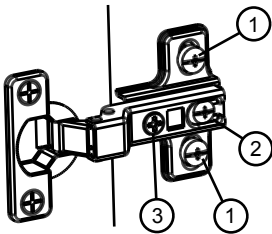
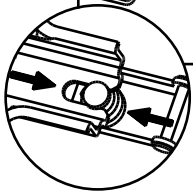
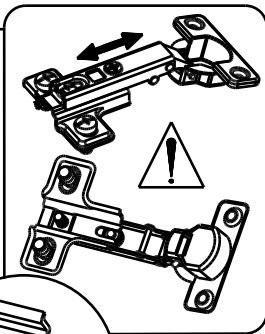

12





1107	X 12

332124	X 3

913	X6

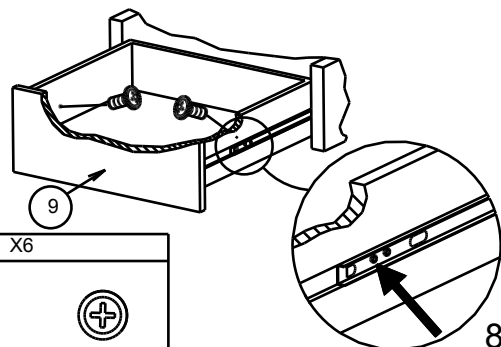
983	X6

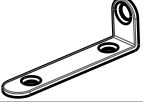

340217	X 2	949	X2
			
		VBA TF 4x15	

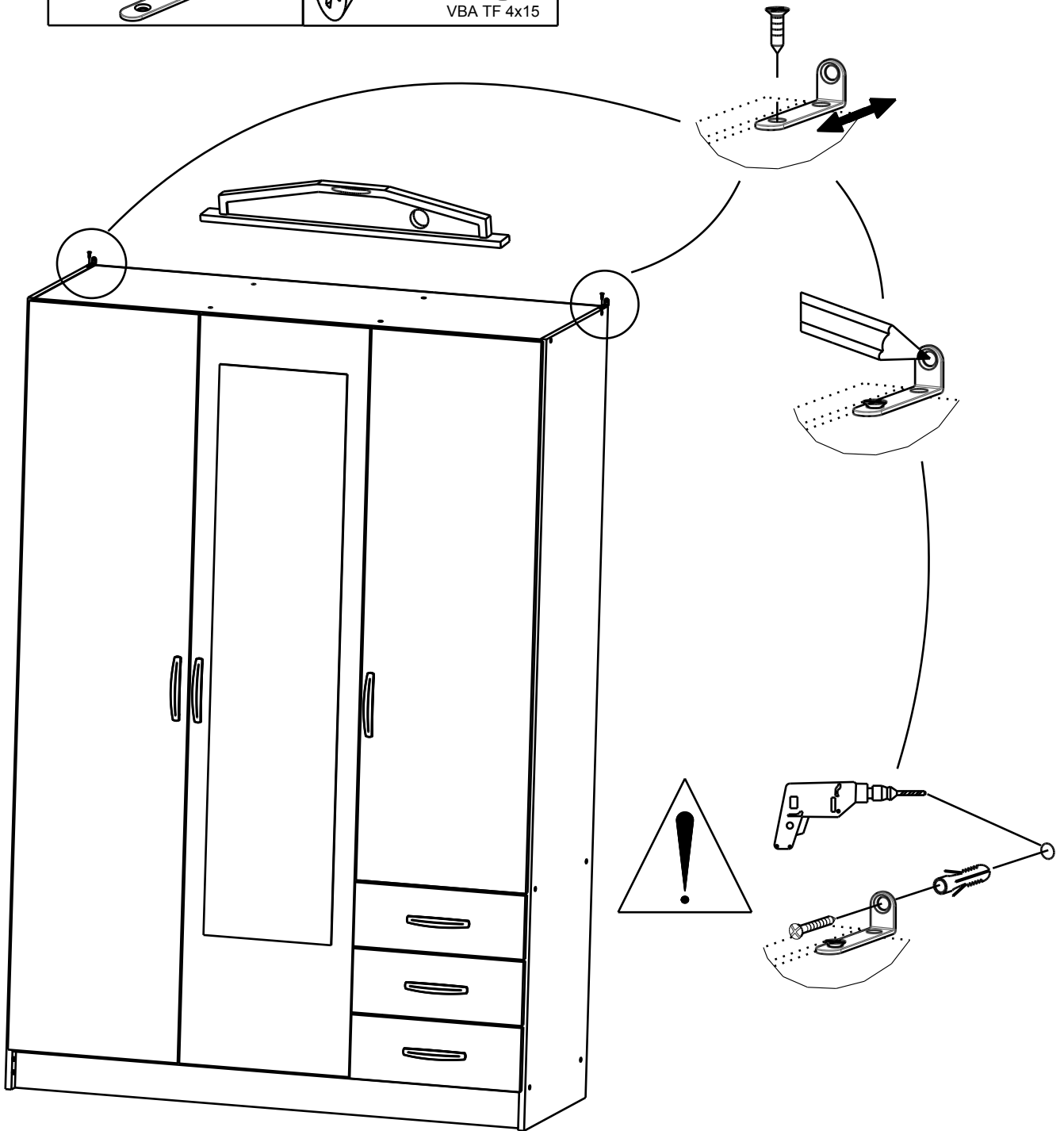

FR MEUBLES A FIXER AU MUR:
 - FIXER LE MEUBLE AU MUR AVEC LES ATTACHES PREVUES A CET EFFET
 - VERIFIER QUE LES VIS ET LES CHEVILLES UTILISEES SONT ADAPTEES AU SUPPORT

ES MUEBLES A FIJAR EN LA PARED:
 - FIJAR EL MUEBLE EN LA PARED CON LAS GRAPAS PREVISTAS
 - COMPROBAR QUE LOS TORNILLOS Y LAS CLAVIJAS UTILIZADAS SON ADAPTADAS AL SOPORTE

PT MOVEIS A FIXAR NA PAREDE:
 - FIXAR O MOVEL NA PAREDE COM OS PRENDES PREVISTOS
 - VERIFICAR QUE OS PARAFUSOS E AS CAVILHAS UTILIZADOS SAO ADAPTADOS OA SUPORTE

EN FURNITURES TO BE HOLD ON THE WALL:
 - HOLD THE FURNITURE ON THE WALL WITH THE FASTENINGS PROVIDED FOR THIS PURPOSE
 - CHECK THAT THE SCREW AND PEGS FIT WITH THE SUPPORT

IT MOBILI DA FISSARE AL MURO:
 - FISSARE IL MOBILE AL MURO CON LE FLANGIE PREVISTE A TALE SCOPO
 - VERIFICARE CHE LE VITI ED I PERNI USATI SIANO ADATTI A QUEL TIPO DI SUPPORTO

PL MEBEL PRZEZNACZONY DO ZAINSTALOWANIA NA ŚCIANIE:
 - NALEŻY ZAMONTOWAĆ TEN MEBEL NA ŚCIANIE PRZEZNACZONYMI DO TEGO CELU UCHWYTAMI
 - NALEŻY SPRAWDZIĆ CZY ŚRUBY I KOSZULKI SĄ ODPWIEDNIEJ WIELKOŚCI W STOSUNKU DO UCHWYTÓW

DE MOEBEL AN DER MAUER ZU BEFESTIGEN
 - BEFESTIGEN SIE DAS MOEBELSTUECK MIT DEN DAFUER VORGESEHENEN BEFESTIGUNGSHAKEN
 - UEBERPRUEFEN SIE BITTE DASS DIE SCHRAUBEN UND DUEBEL MIT DEM MATERIAL DER MAUER UEBEREINSTIMMEN

NL MEUBELS DIE AAN DE MUUR GEFIXEERD MOETEN WORDEN:
 - FIXEER HET MEUBEL AAN DE MUUR MET DE DAARVOOR BESTEMDE HAKEN
 - VERFIEER OF DE GEBRUIKTE SCHROEVEN BIJ DE BEVESTIGINGSHAAK HOREN