

MONTAGEANLEITUNG INSTRUKCJA MONTAŻOWA

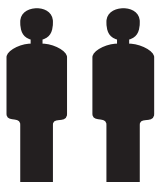

2 Personen
2 Osoby

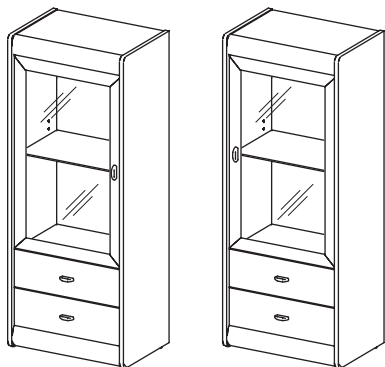
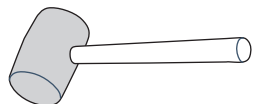
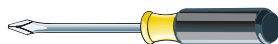
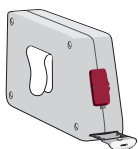

TYPE "L" TYPE "R"

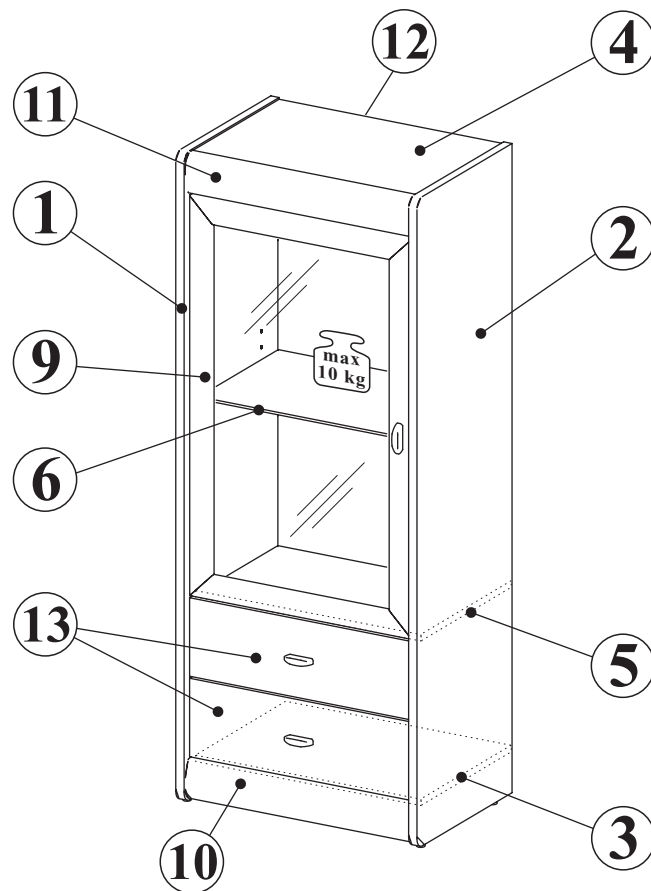

**MONTOWAĆ
 NA ROZŁOŻONYM KARTONIE!**

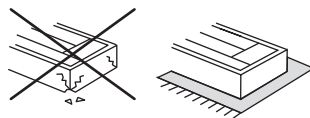

**Wskazówka dotycząca
 pielęgnacji!**

Proszę czyścić tylko suchą
 lub lekko wilgotną szmatką do kurzu.
 Nie używać żadnych środków szorstkich!
 Maksymalne obciążenie półek w kg:

Stärke/Gr.	Spanplatte/Płyta		
Länge/Dł. mm	15	18	22
0<400			
401<600	40	40	40
601<800	24		
801<1000	15	30	

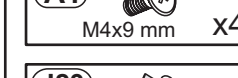
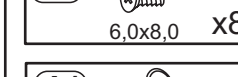
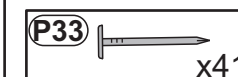
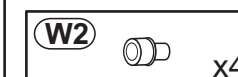
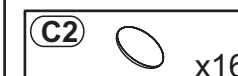
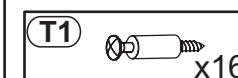
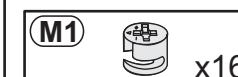
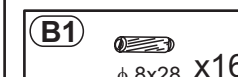
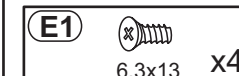
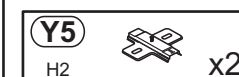
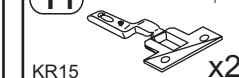
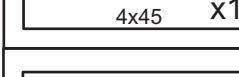
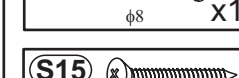
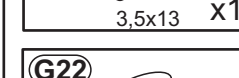
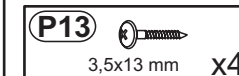
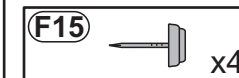

1

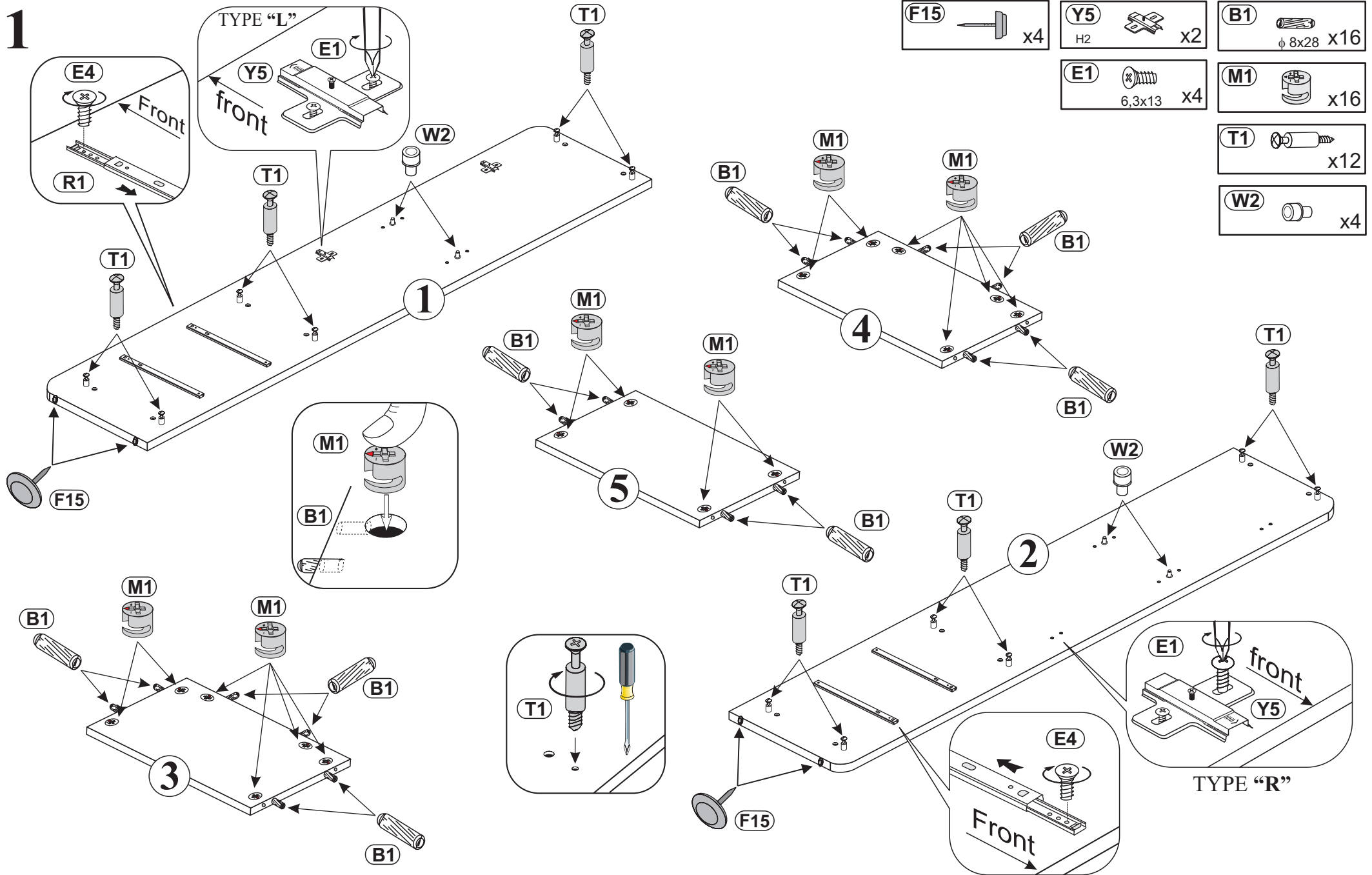

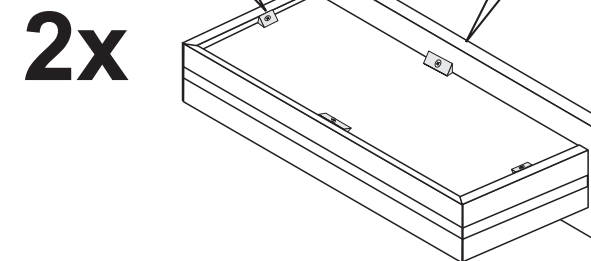
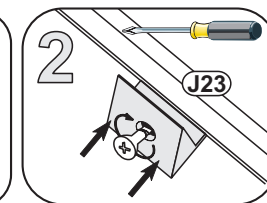
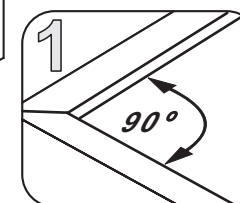
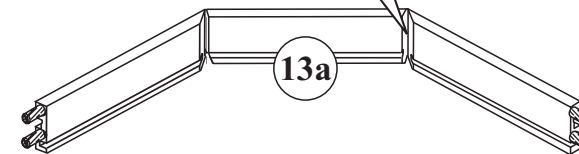
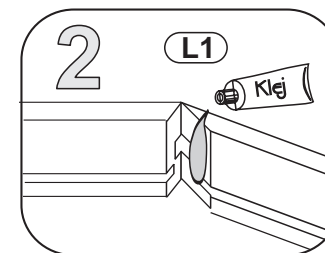
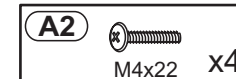
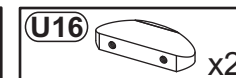
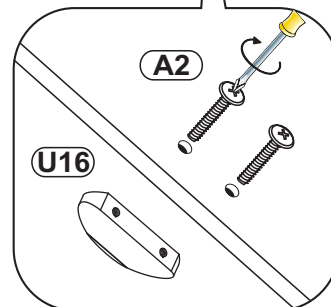
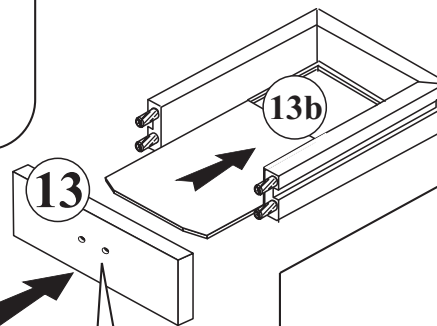
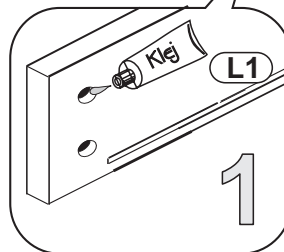
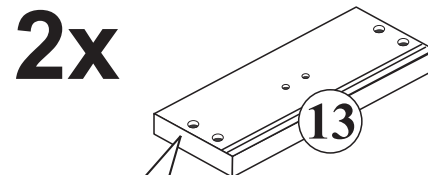
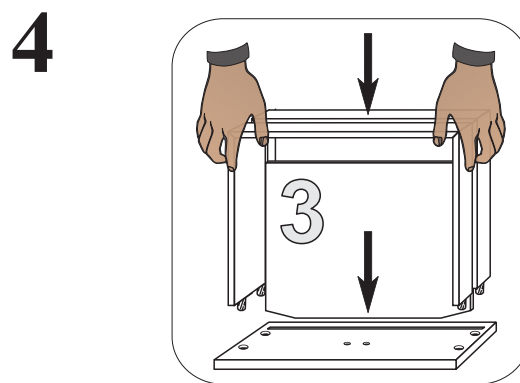
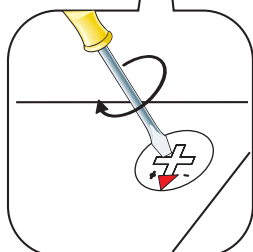
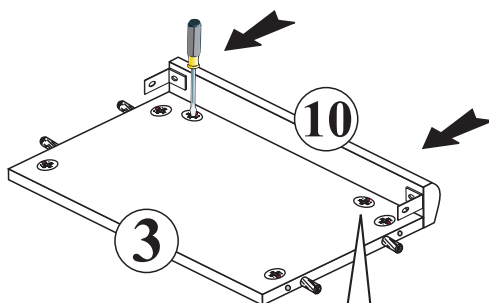
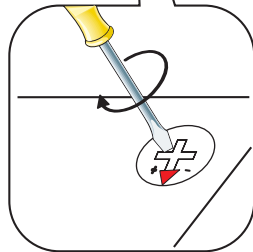
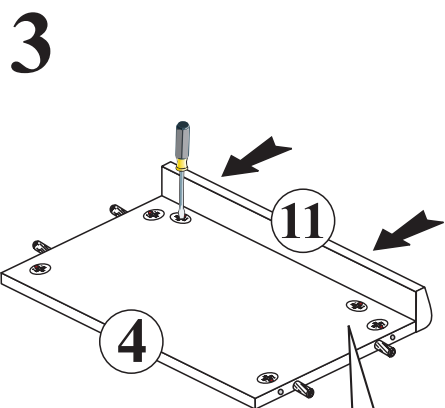
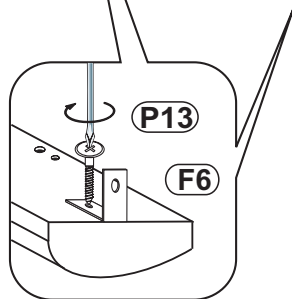
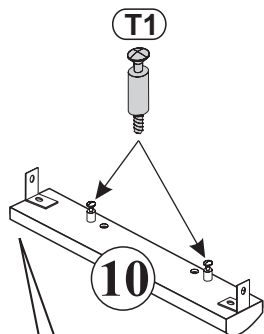
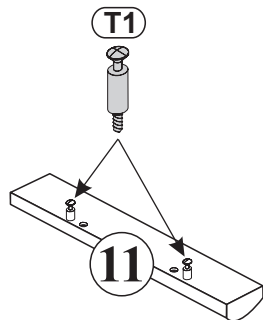
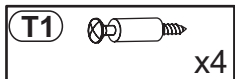
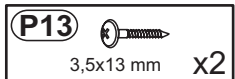

6

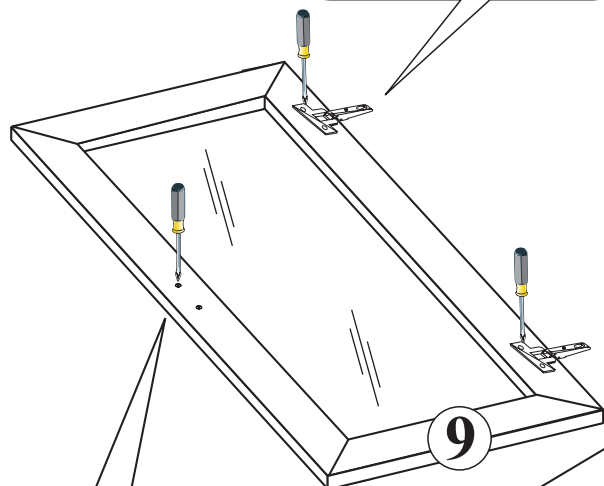
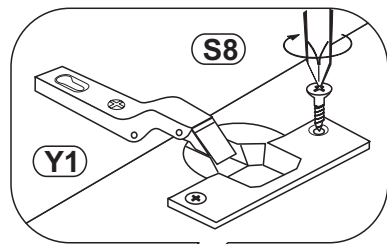
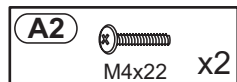
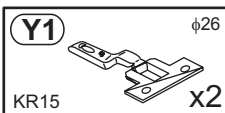
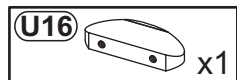

9

7

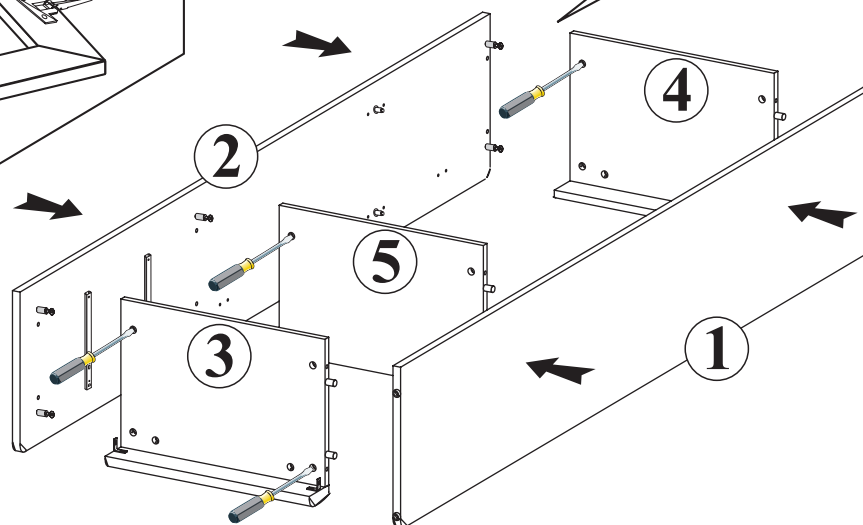
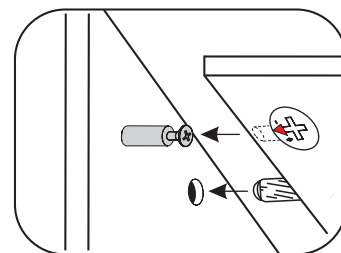
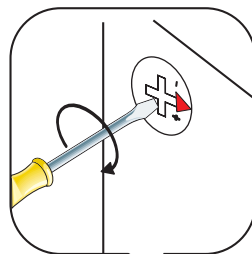
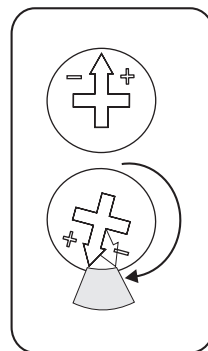

8

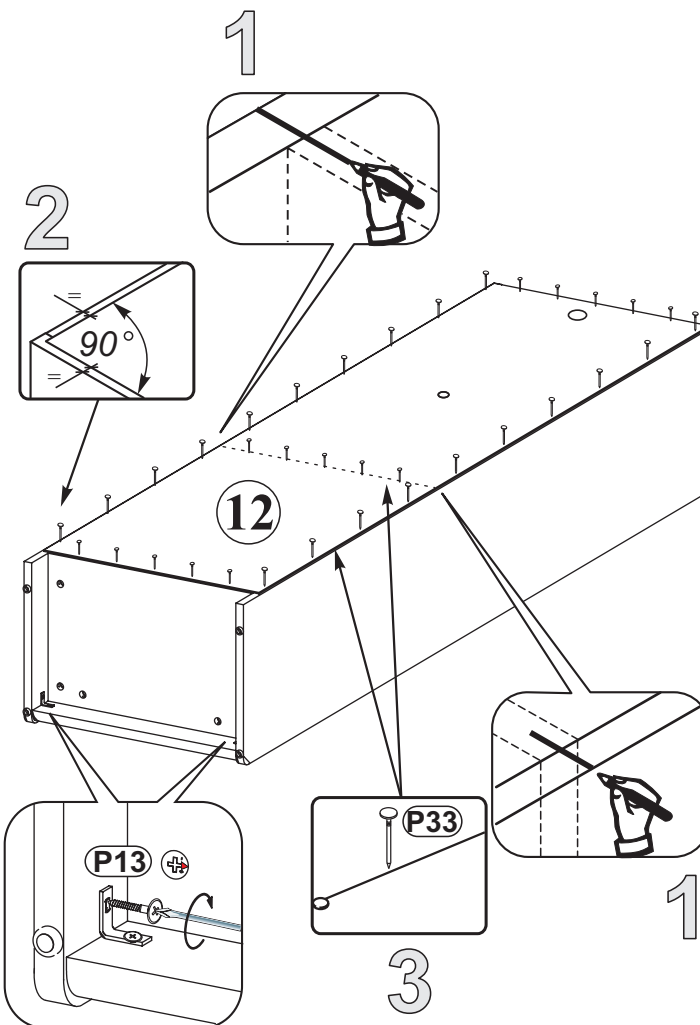
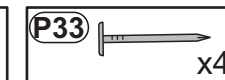
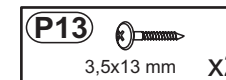

9

