

Modellname:  
Nazwa modelu:

**DOVER**

Modellreihe:  
Numer modelu:

**SL -- 08**

Type:  
Typ:

**08**

Blatt Nr  
Strona

von:  
z:

# MONTAGEANLEITUNG INSTRUKCJA MONTAŻOWA

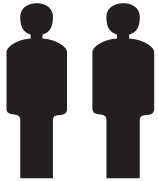
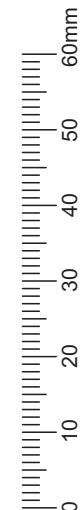
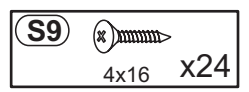
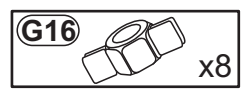
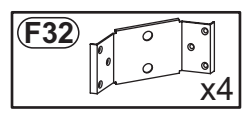
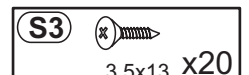
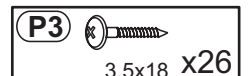
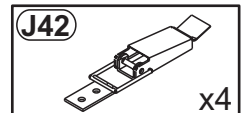
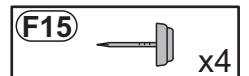
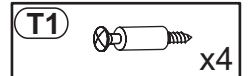
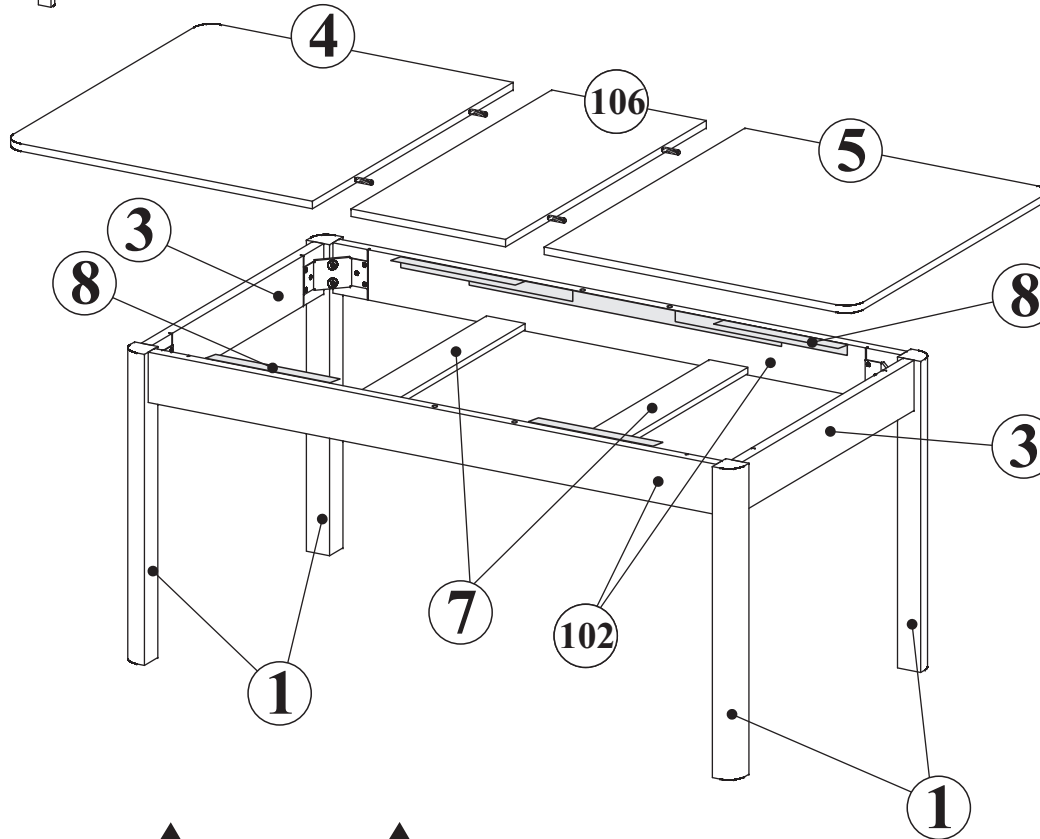
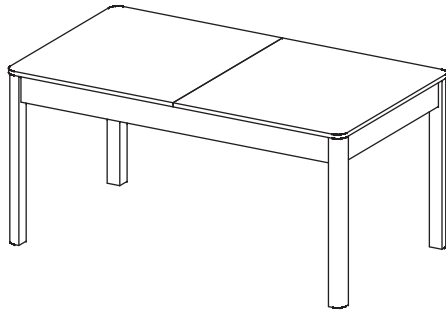

**2 Personen  
2 Osoby**

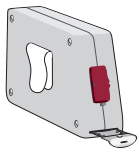

MONTOWAĆ  
NA ROZŁOŻONYM KARTONIE!

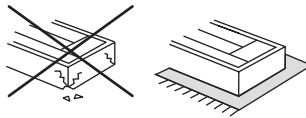



Wskazówka dotycząca  
pielęgnacji!

Proszę czyścić tylko suchą  
lub lekko wilgotną szmatką do kurzu.  
Nie używać żadnych środków szorstkich!  
Maksymalne obciążenie półek w kg:

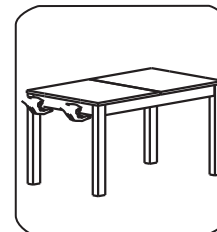
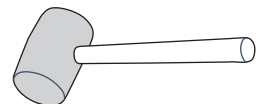
Stärke/Gr. Länge/Dł. mm	Spanplatte/Płyta		
	15	18	22
0<400			
401<600	40	40	40
601<800	24		
801<1000	15	30	

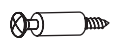

# 1

- P3**  3,5x18 x14
- B1**   $\phi$  8x28 x24
- M1**  x4
- T1**  x4

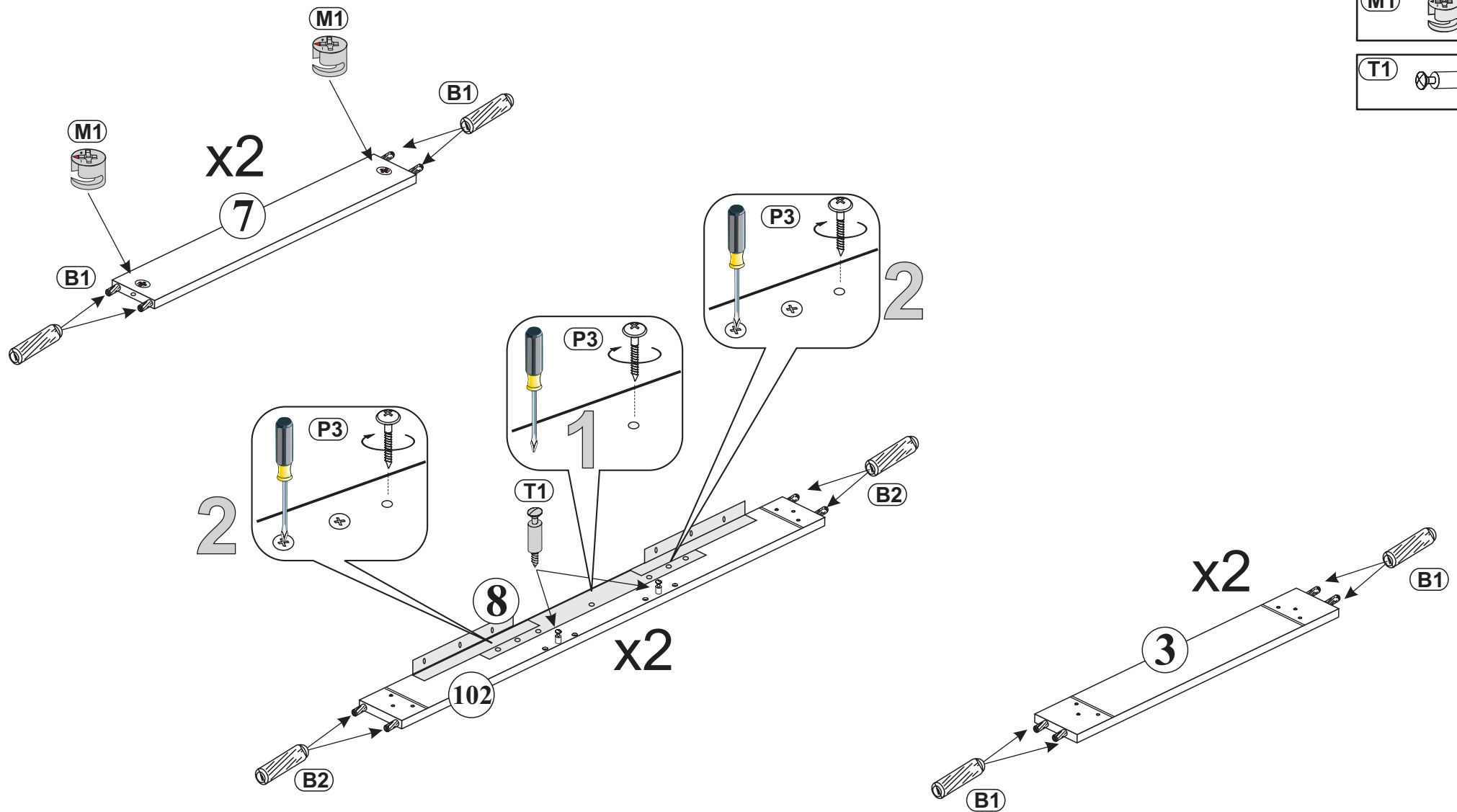

**2**

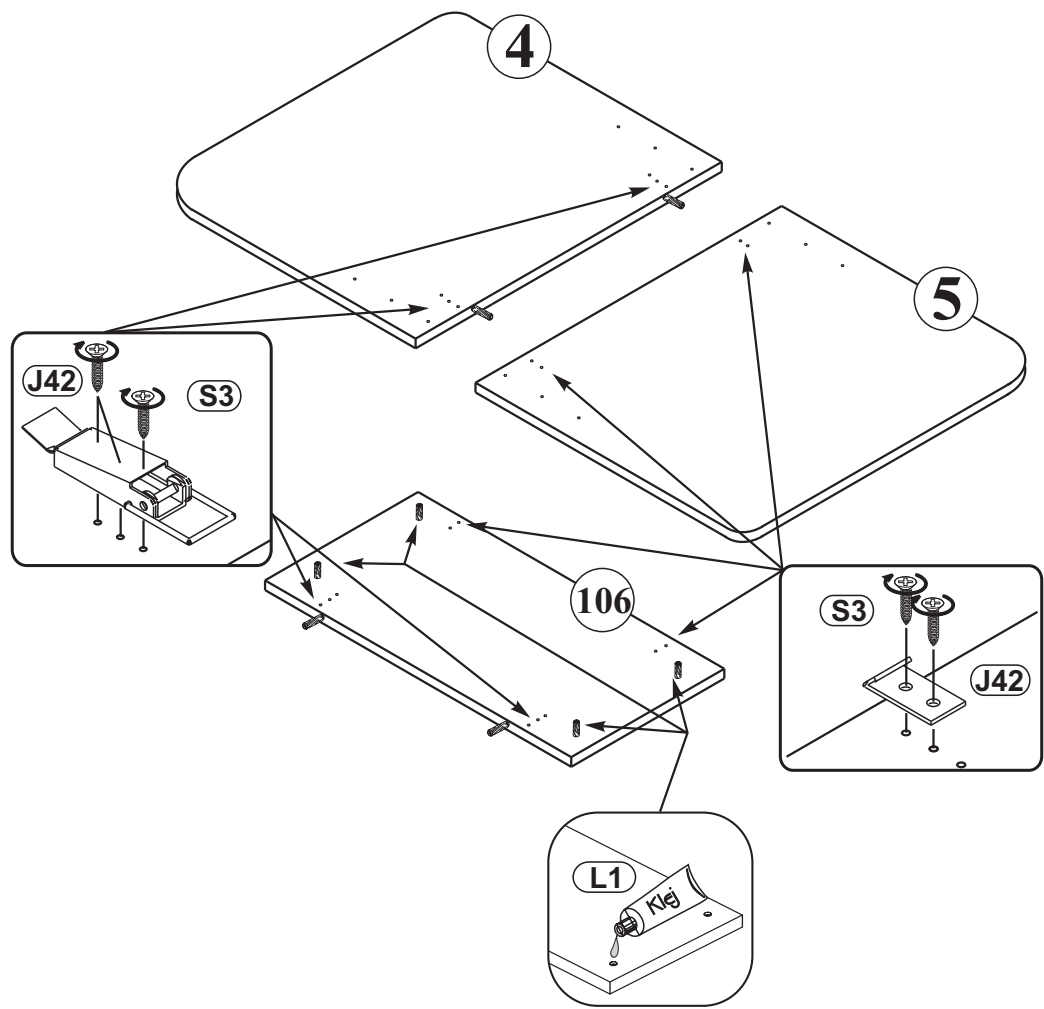
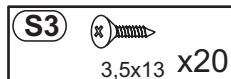
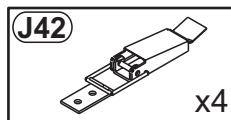
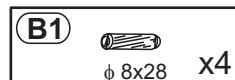

**3**

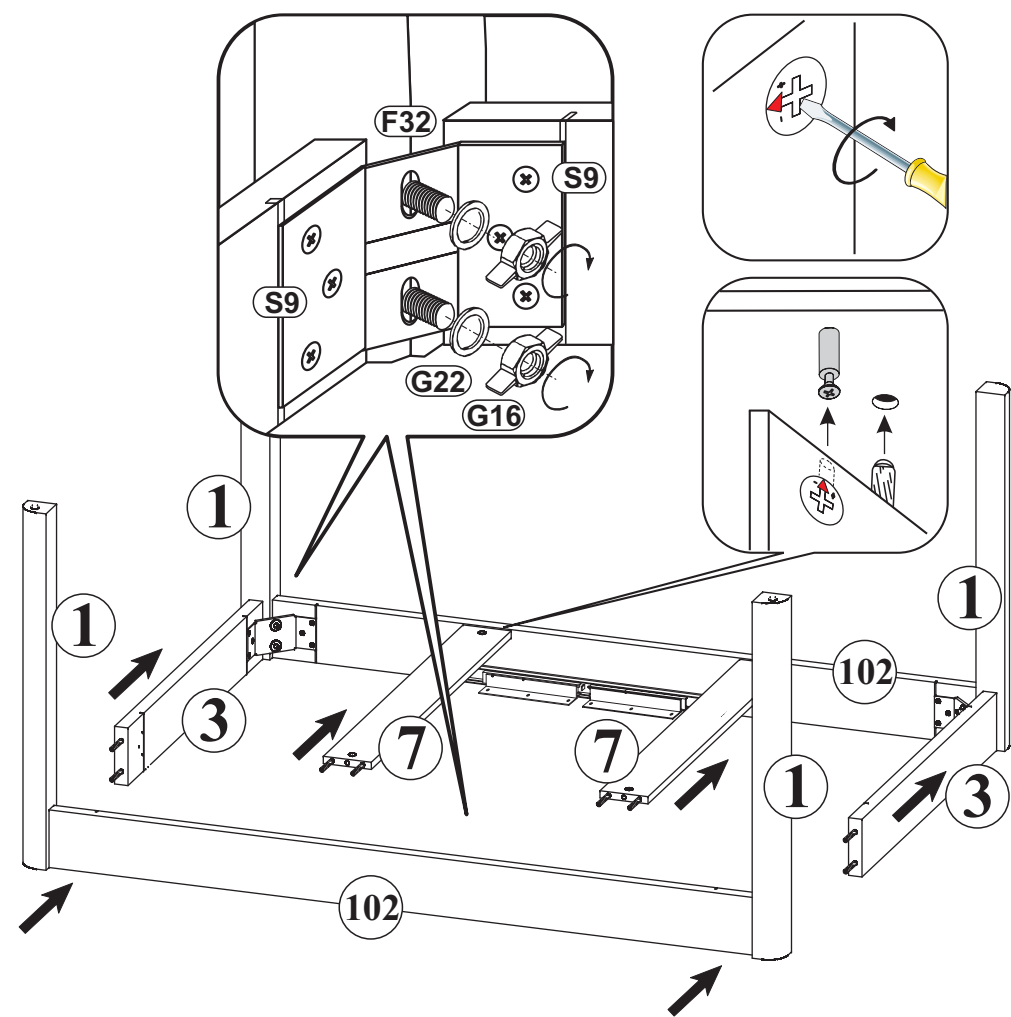
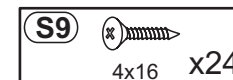
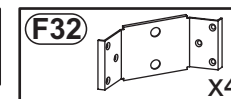

**4**

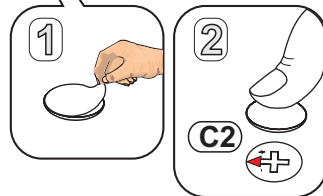
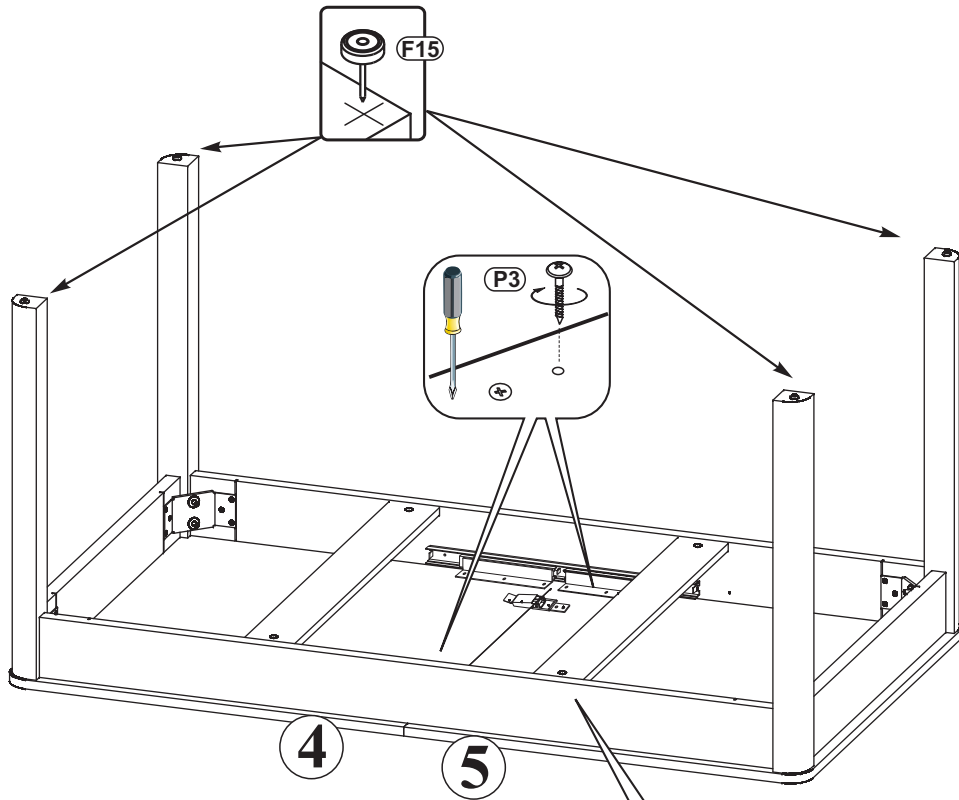
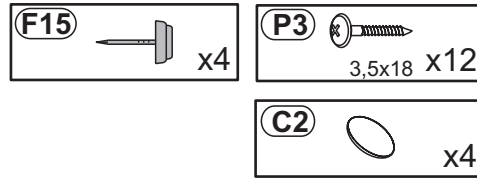

**5**

