

MONTAGEANLEITUNG

INSTRUKCJA MONTAŻOWA

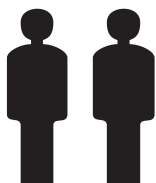

2 Personen
2 Osoby

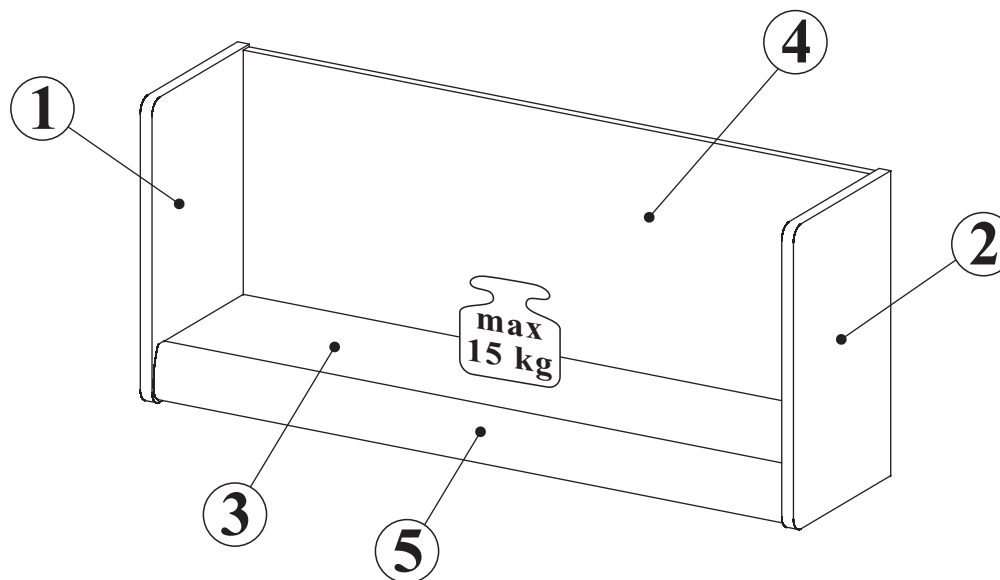
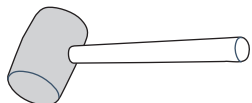
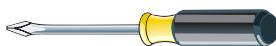
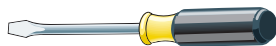
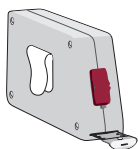

MONTOWAĆ
NA ROZŁOŻONYM KARTONIE!

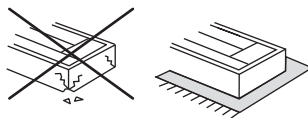

Wskazówka dotycząca
pielęgnacji!

Proszę czyścić tylko suchą
 lub lekko wilgotną szmatką do kurzu.
 Nie używać żadnych środków szorstkich !
 Maksymalne obciążenie półek w kg:

| Länge/Dł. mm | Stärke/Gr. Spanplatte/Płyta | | |
|--------------|-----------------------------|----|----|
| | 15 | 18 | 22 |
| 0<400 | | | |
| 401<600 | 40 | 40 | 40 |
| 601<800 | 24 | | |
| 801<1000 | 15 | 30 | |

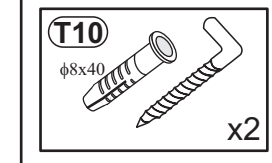
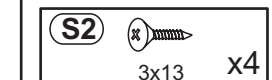
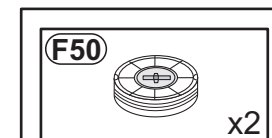
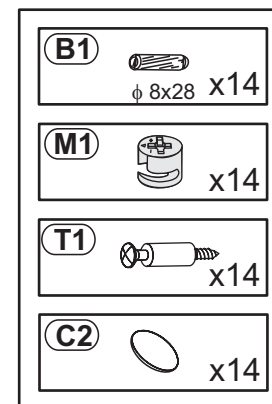

1

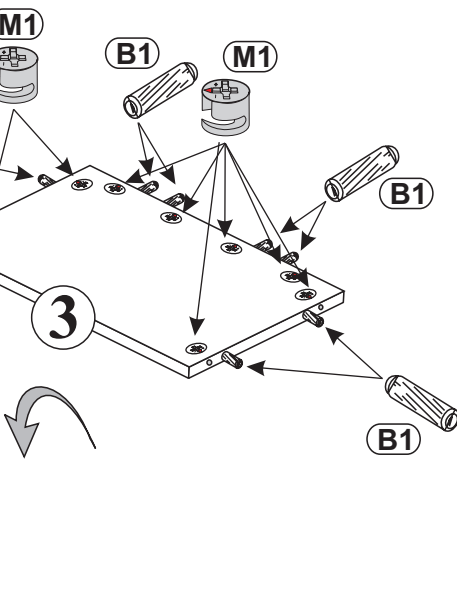
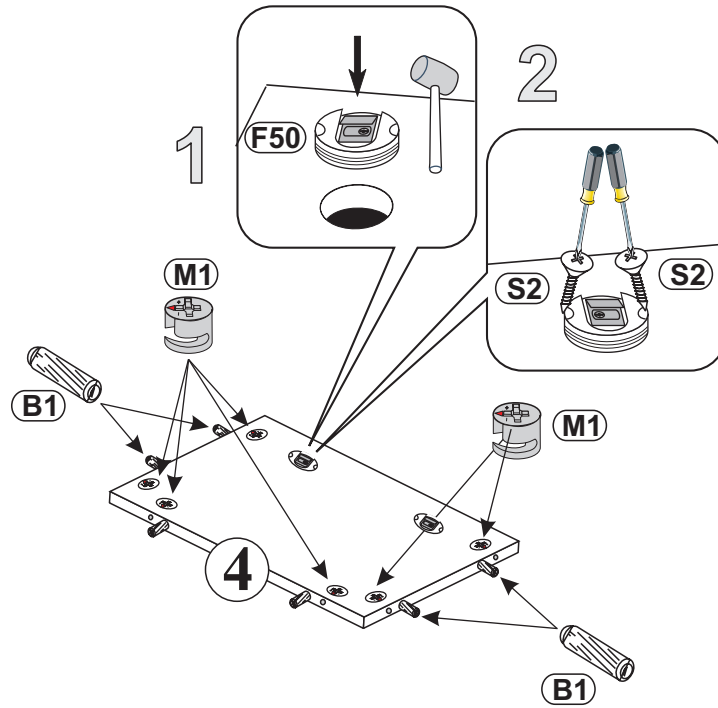
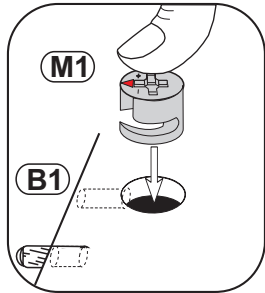
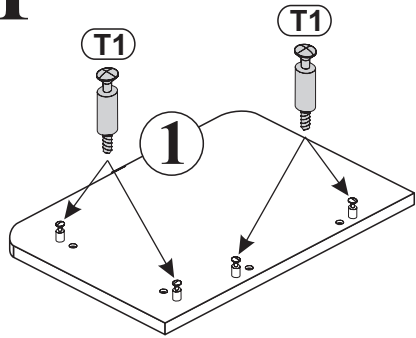

2

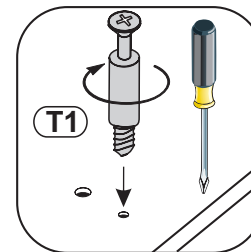
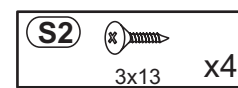
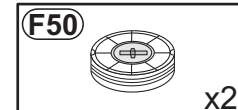
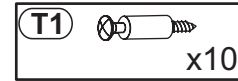
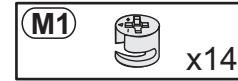
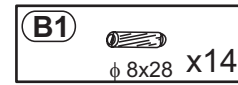
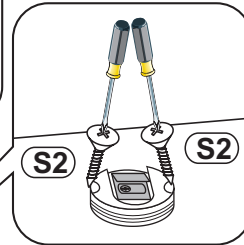

2

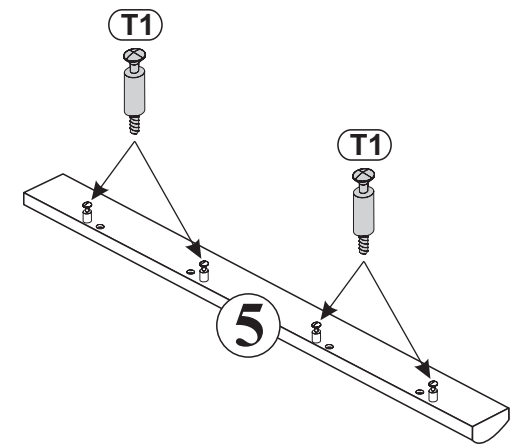
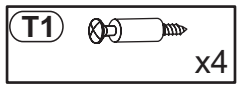

3

