

Demeyere

GROUP

SAV
SPAREPARTS
KUNDEDIENST
POST VENTAS
SERVICE NA VERKOOP
SERVIZIO POST-VENDITA
SERVICO DEPOIS DE VENDA
SERWIS POGWARANCYJNY

479061 1

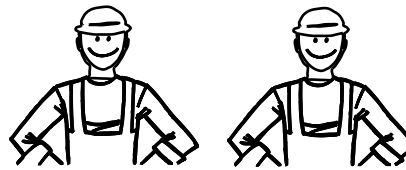
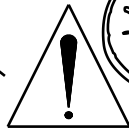
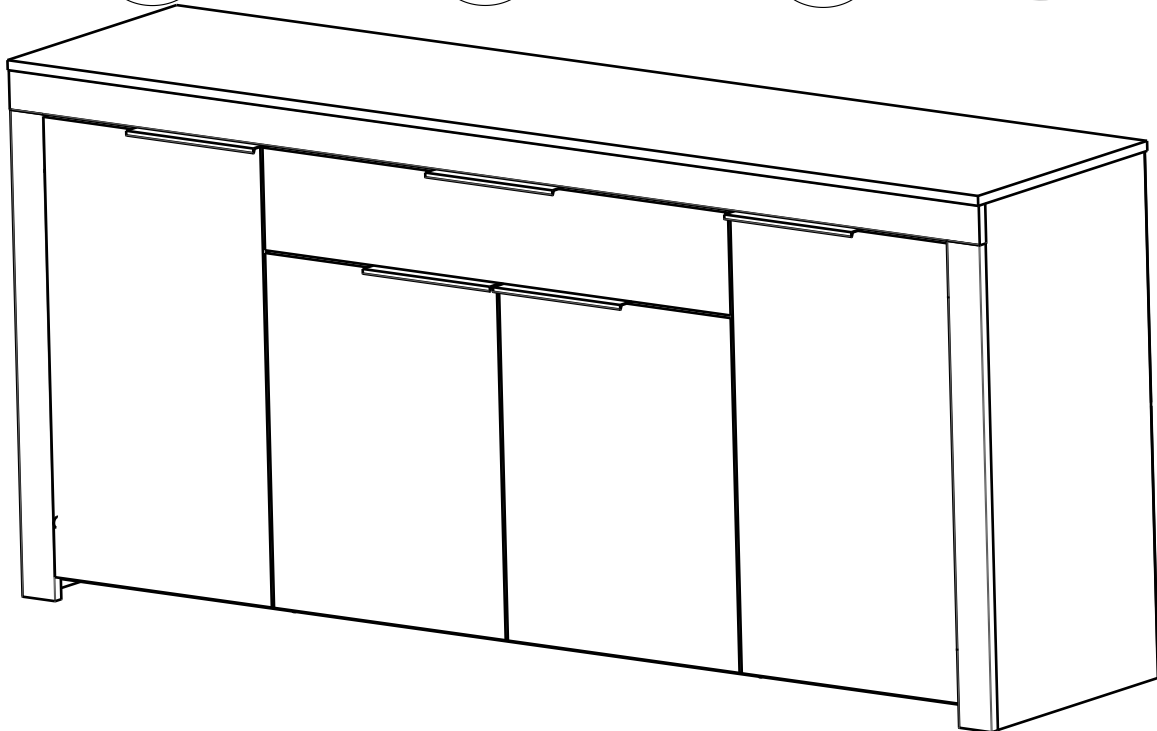
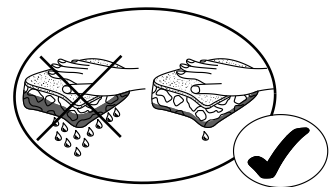
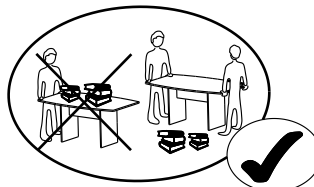
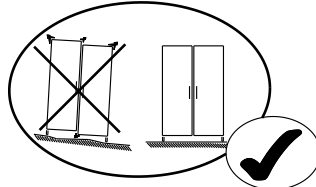
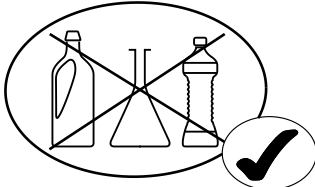

2H 00MN

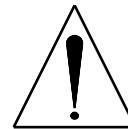

(FR) SECURITE

RESPECTER LES INSTRUCTIONS DE MONTAGE DECRITES DANS LA NOTICE.

(EN) CAUTION

FOLLOW CAREFULLY THE ASSEMBLING INSTRUCTIONS DESCRIBED IN THE DIRECTIONS.

(DE) SICHERHEITSVORSCHRIFTEN

BEACHTEN SIE BITTE UNBEDINGT DIE ANGEGEBENEN AUFBAUVORSCHRIFTEN.

(ES) SEGURIDAD

RESPECTAR LAS INSTRUCCIONES DE MONTAJE DESCRIBIDAS EN EL FOLLETO.

(NL) VEILIGHEID

DE IN DE GEBRUIKSAANWIJZING BESCHREVEN INSTRUCTIES RESPECTEREN.

(IT) SICUREZZA

RISPETTARE LE ISTRUZIONI DI MONTAGGIO DESCRITTE NEEL'AVVERTENZA.

(PT) SEGURANCA

RESPEITAR AS INSTURAÇOS DE MONTAGEM DESCREVEDAS NA INSTRUÇOES DE USO.

(PL) UWAGA

PROSZE PRZESTRZEGAC INSTRUKCJI MONTAZU.

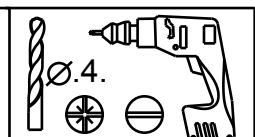
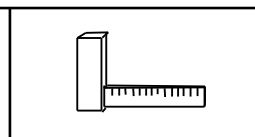
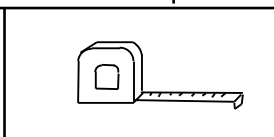
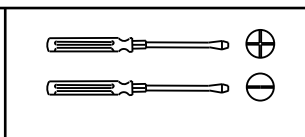
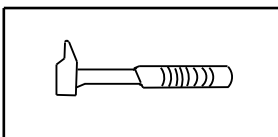

REP	DIM	QTE
1	794 x 397	1
2	794 x 397	1
3	1772 x 419	1
4	1738 x 396	1
5	749 x 395	1
6	749 x 395	1
7	850 x 155	1
8	694 x 396	2
9	436 x 393	2
10	535 x 423	2
11	836 x 393	1
12	325 x 812	1
13	797 x 323	1
14	1766 x 764	1
15	734 x 60	2
16	1771 x 60	1

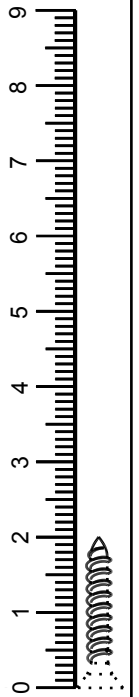
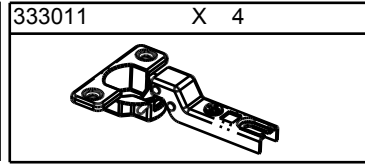
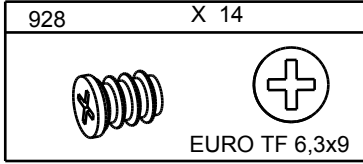
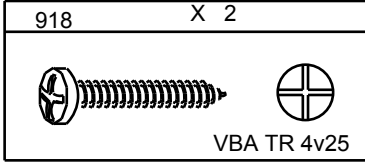
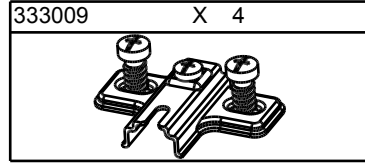
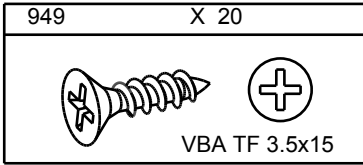
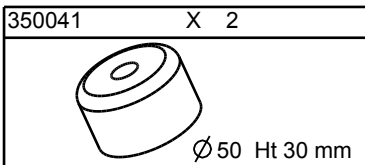
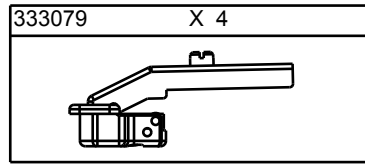
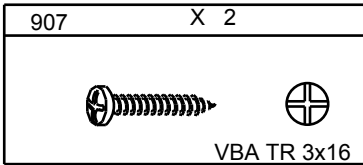
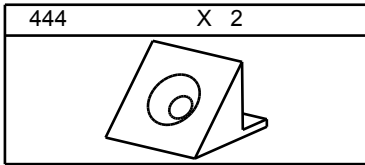
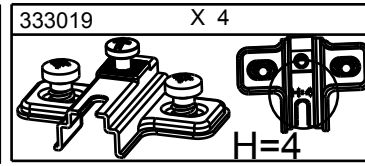
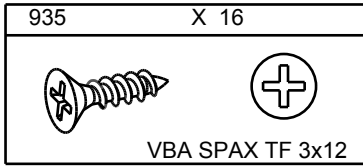
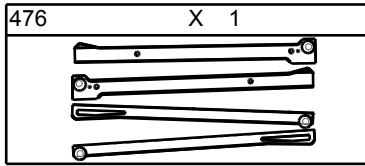
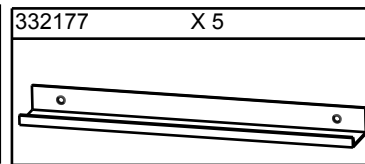
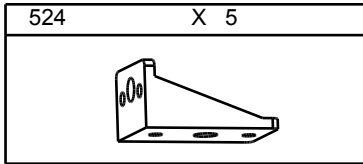
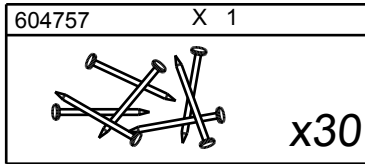
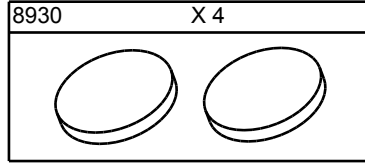
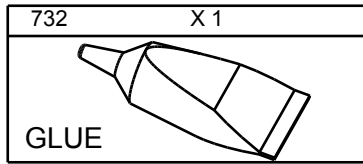
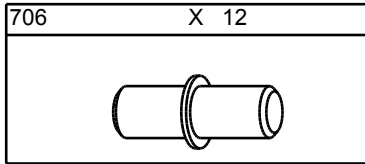
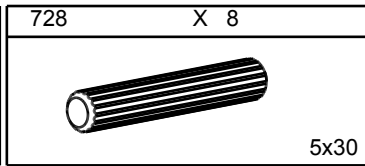
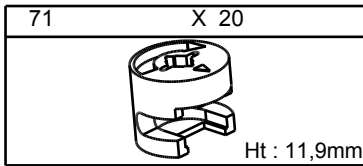
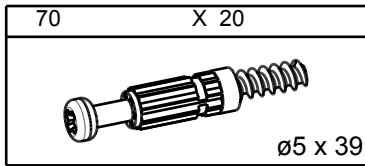
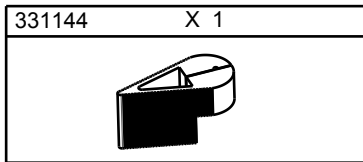
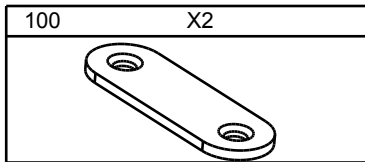
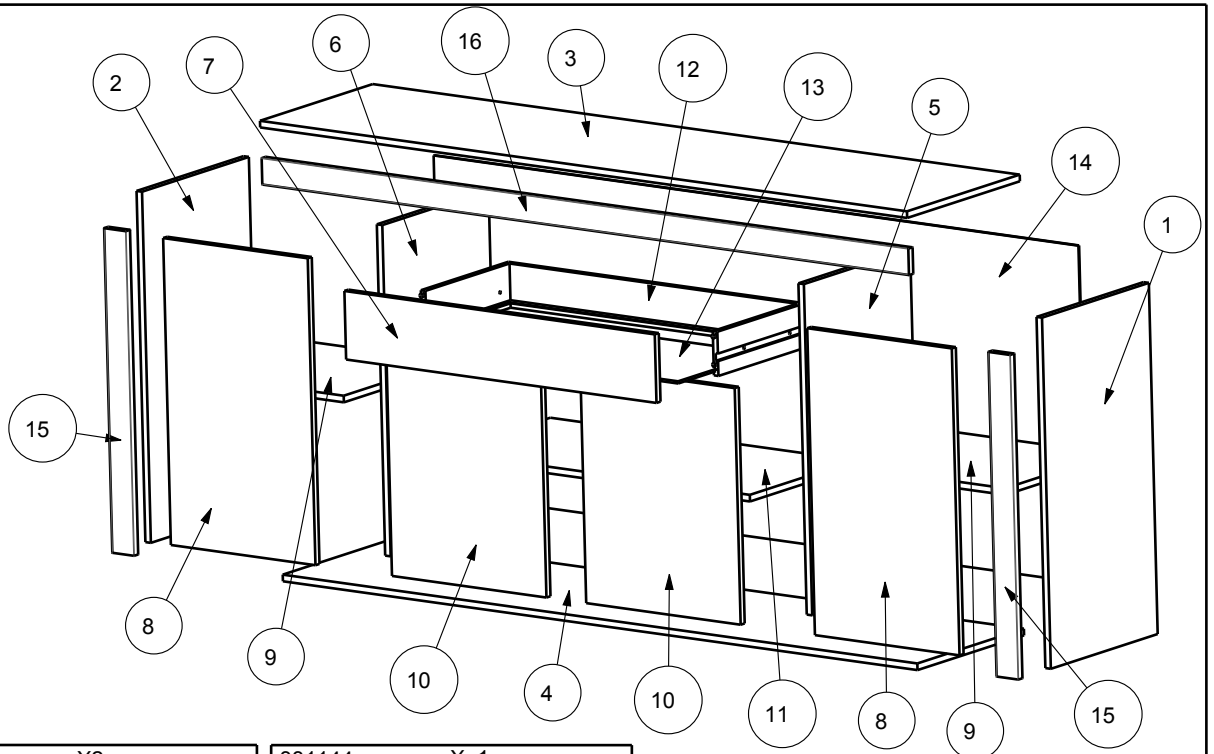

1

332177 X 1	935 X 2	732 X 1

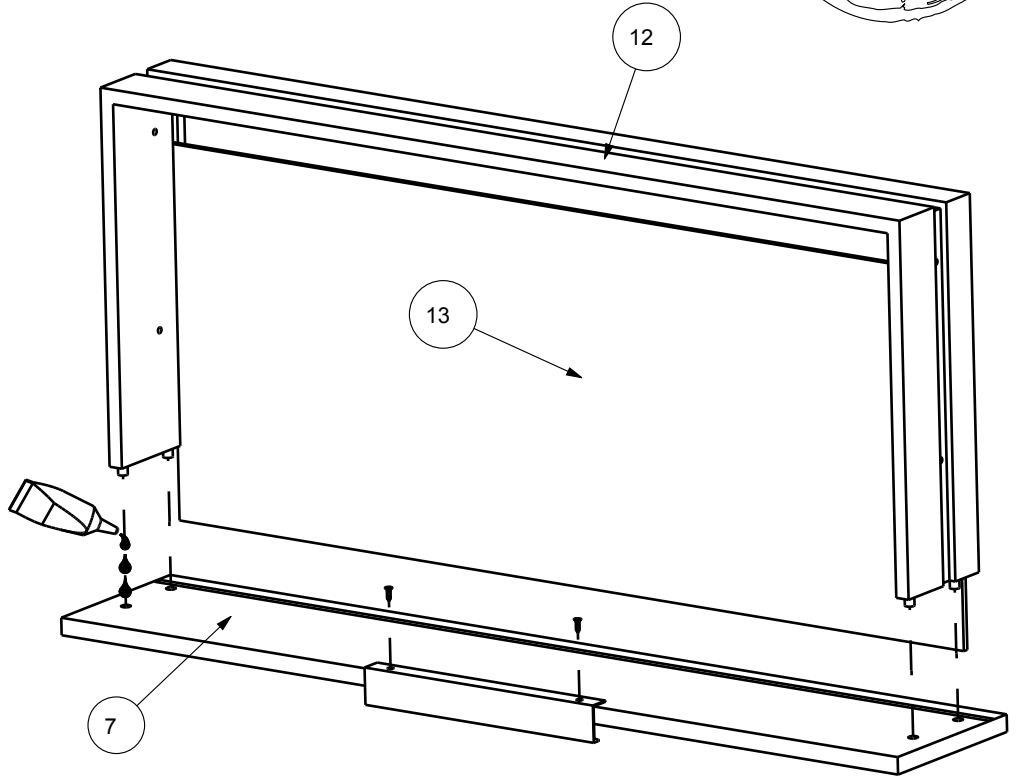
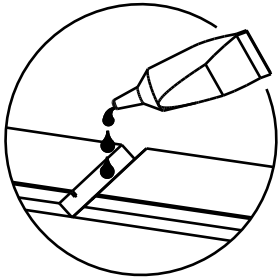
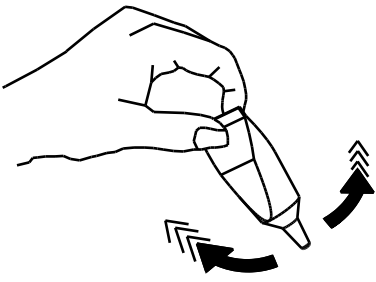

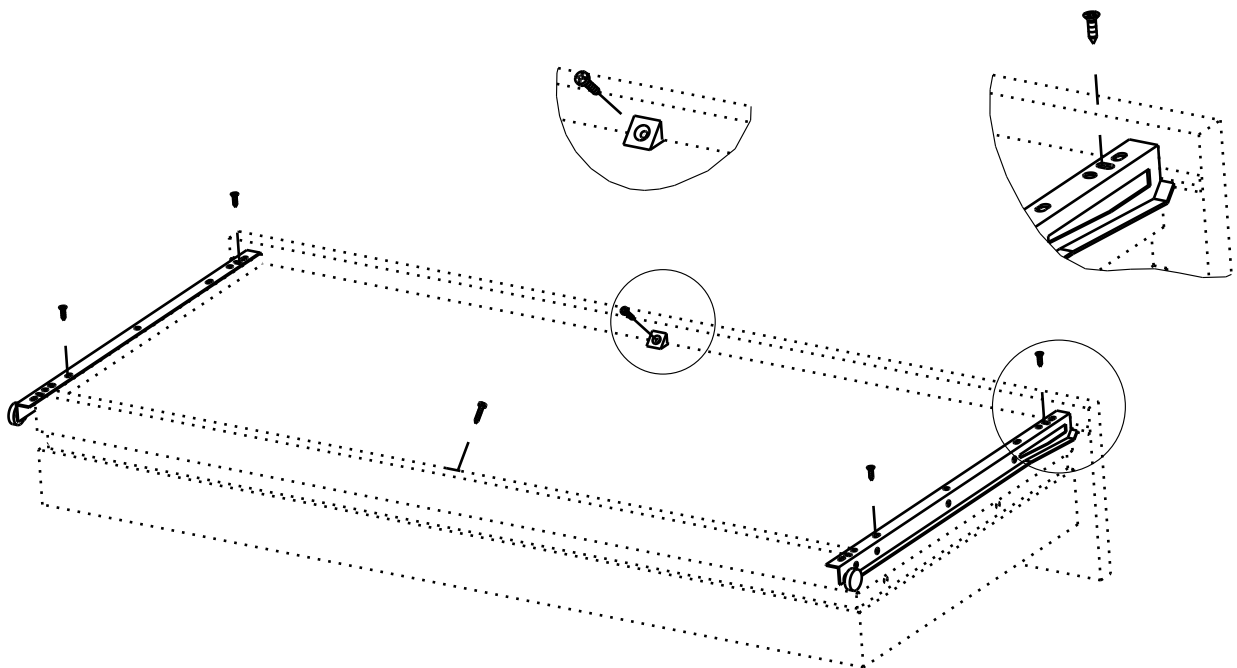

2

444 X 2	907 X 2	476 X 1	935 X 4



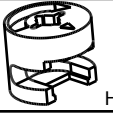

3

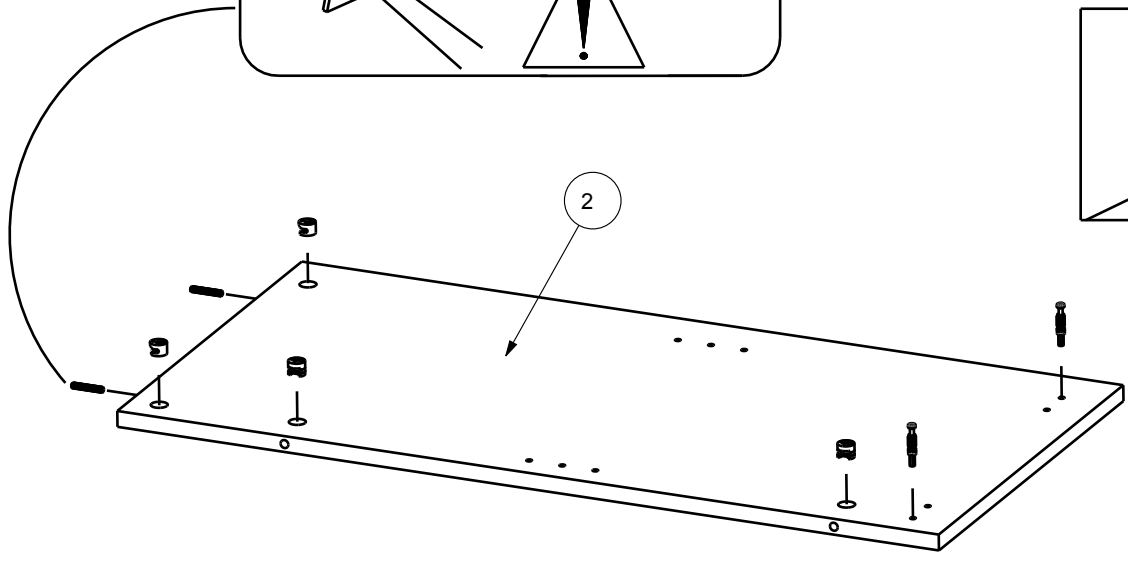
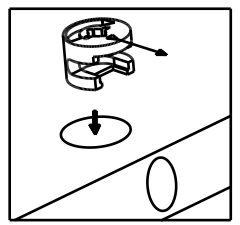
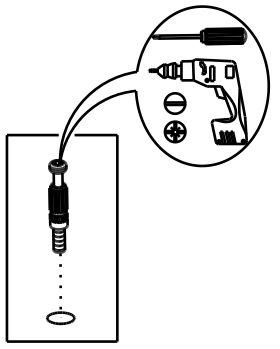
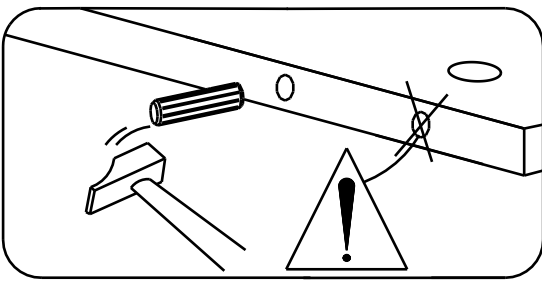
70	X2	71	X4	728	X2
					
$\varnothing 5 \times 39$		Ht: 11,9mm		5x30	

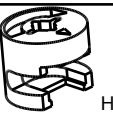

4

70	X2	71	X4	728	X2
					
$\varnothing 5 \times 39$		Ht: 11,9mm		5x30	

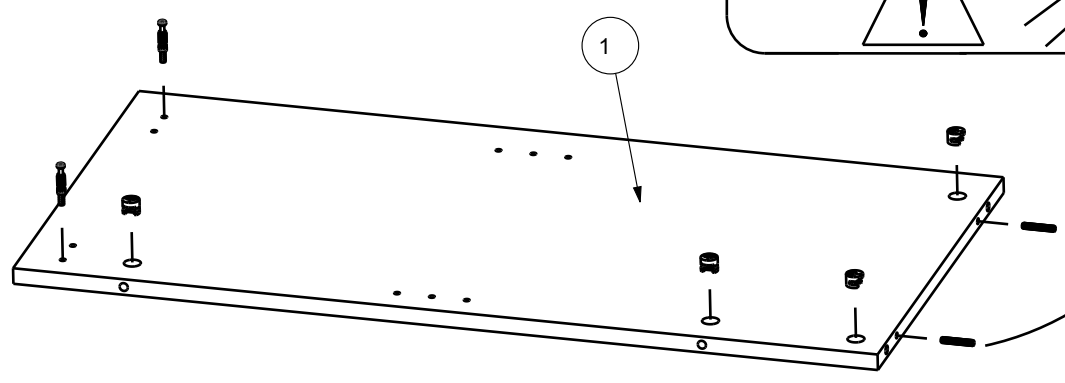
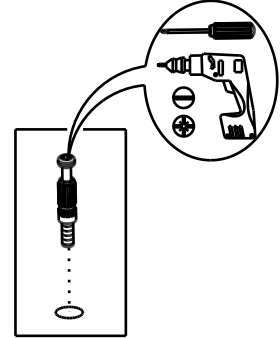
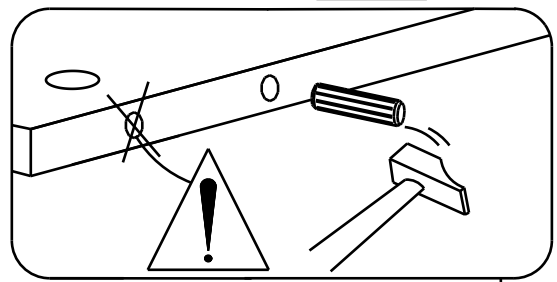
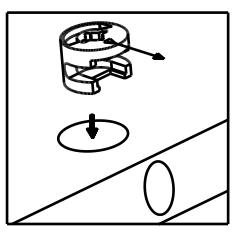

5

71

X 4

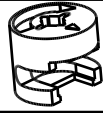

Ht: 11,9mm

728

X 4



5x30

70

X 4



ø5 x 39

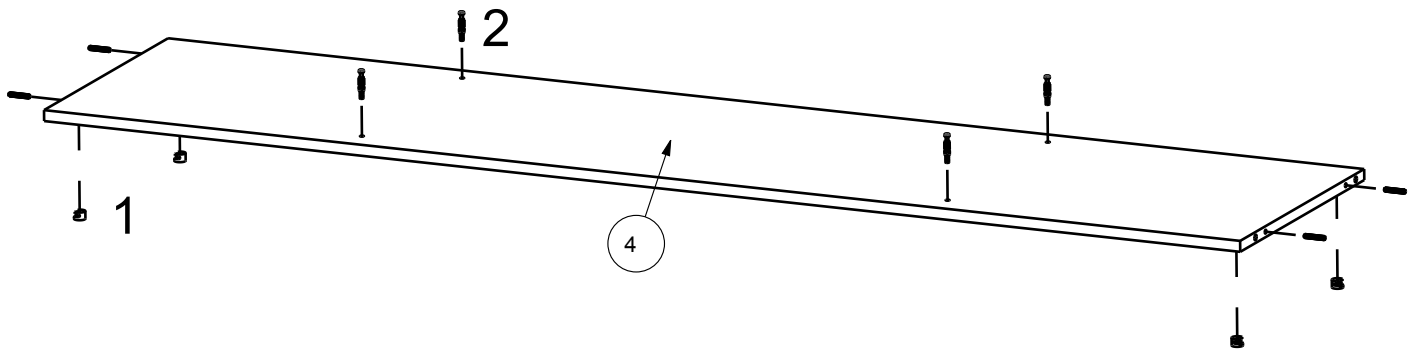
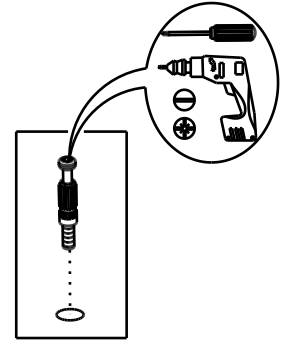
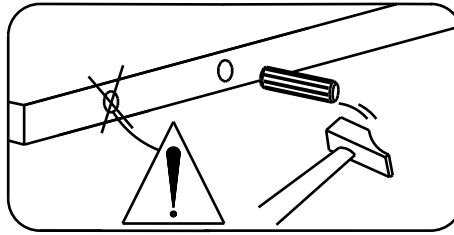
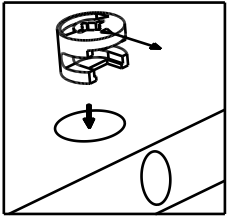

6

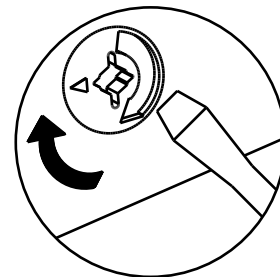

7

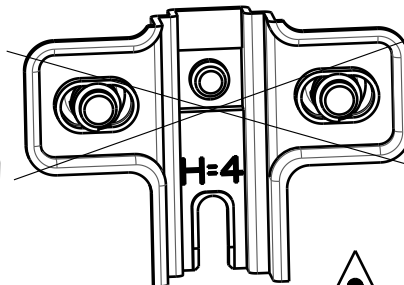
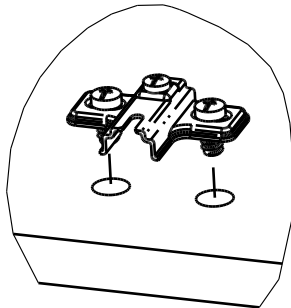
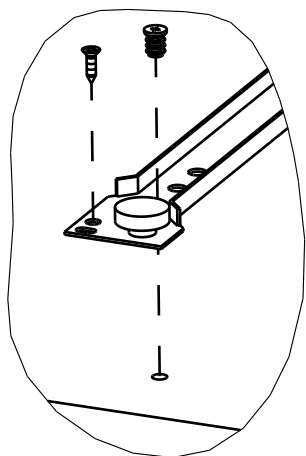
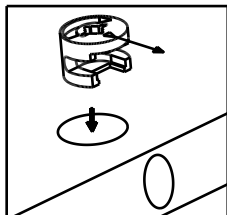
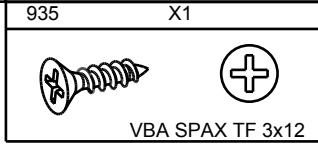
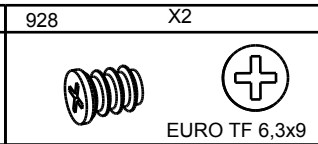
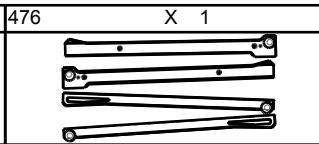
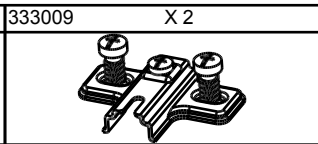
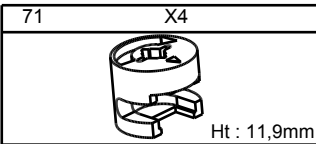

NO

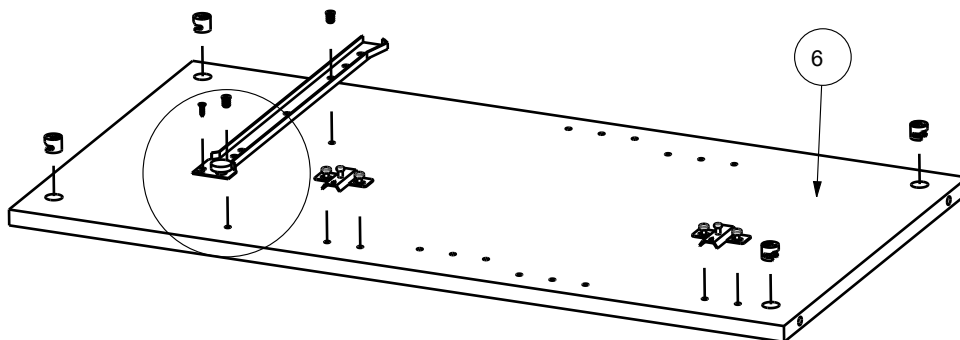



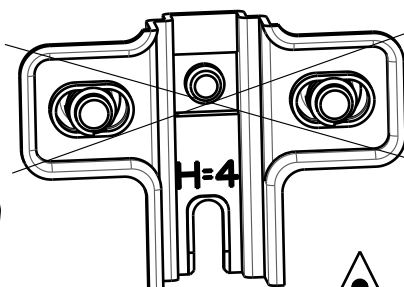
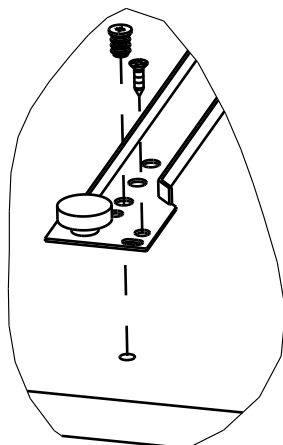
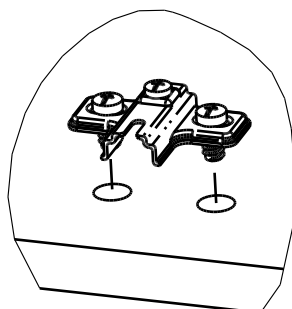
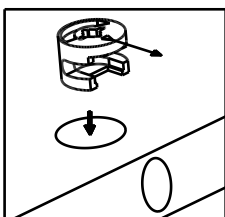
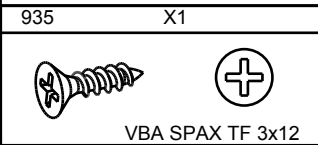
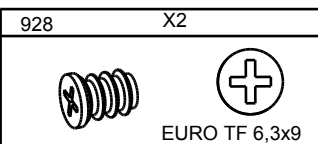
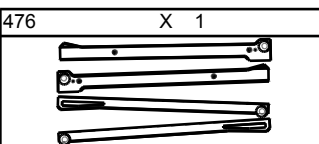
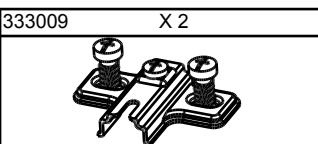
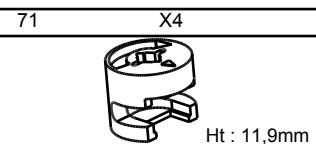

8

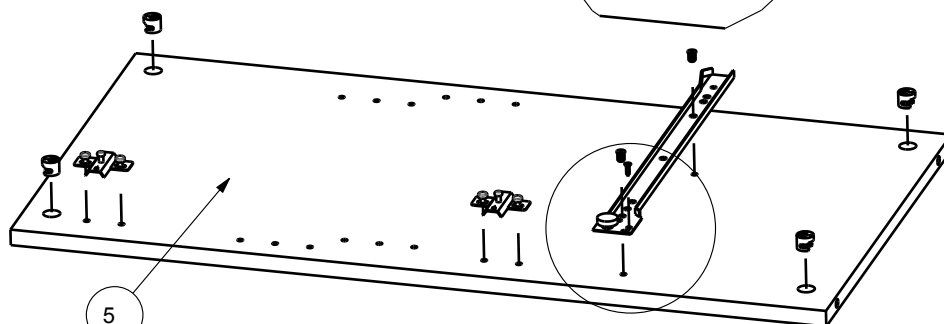

NO

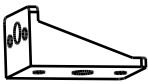

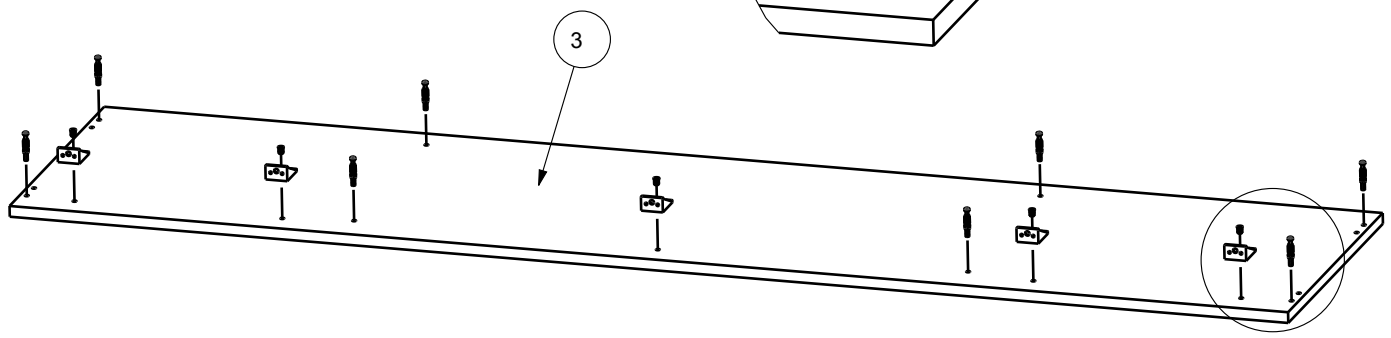
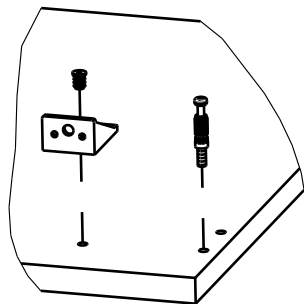
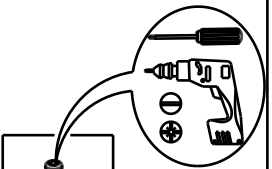

9

524	X 5	928	X 5	70	X 8
					
		EURO TF 6,3x9		ø5 x 39	



10

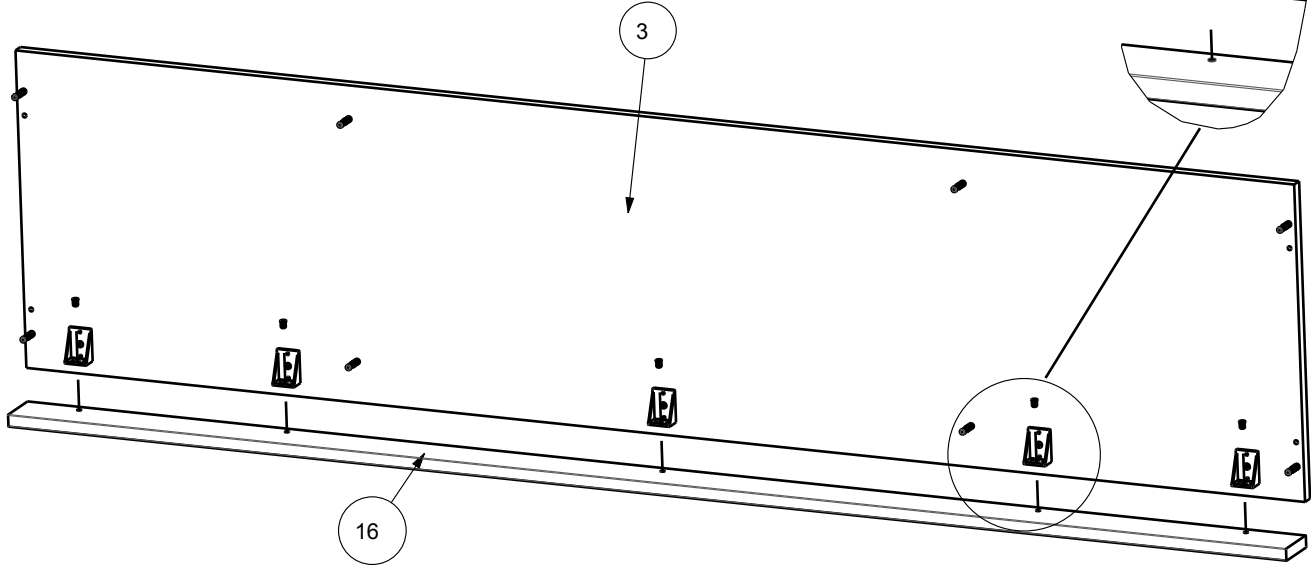
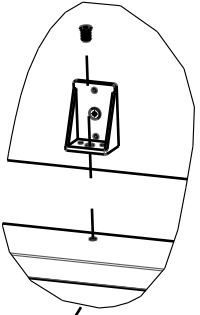

928	X5
	
EURO TF 6,3x9	

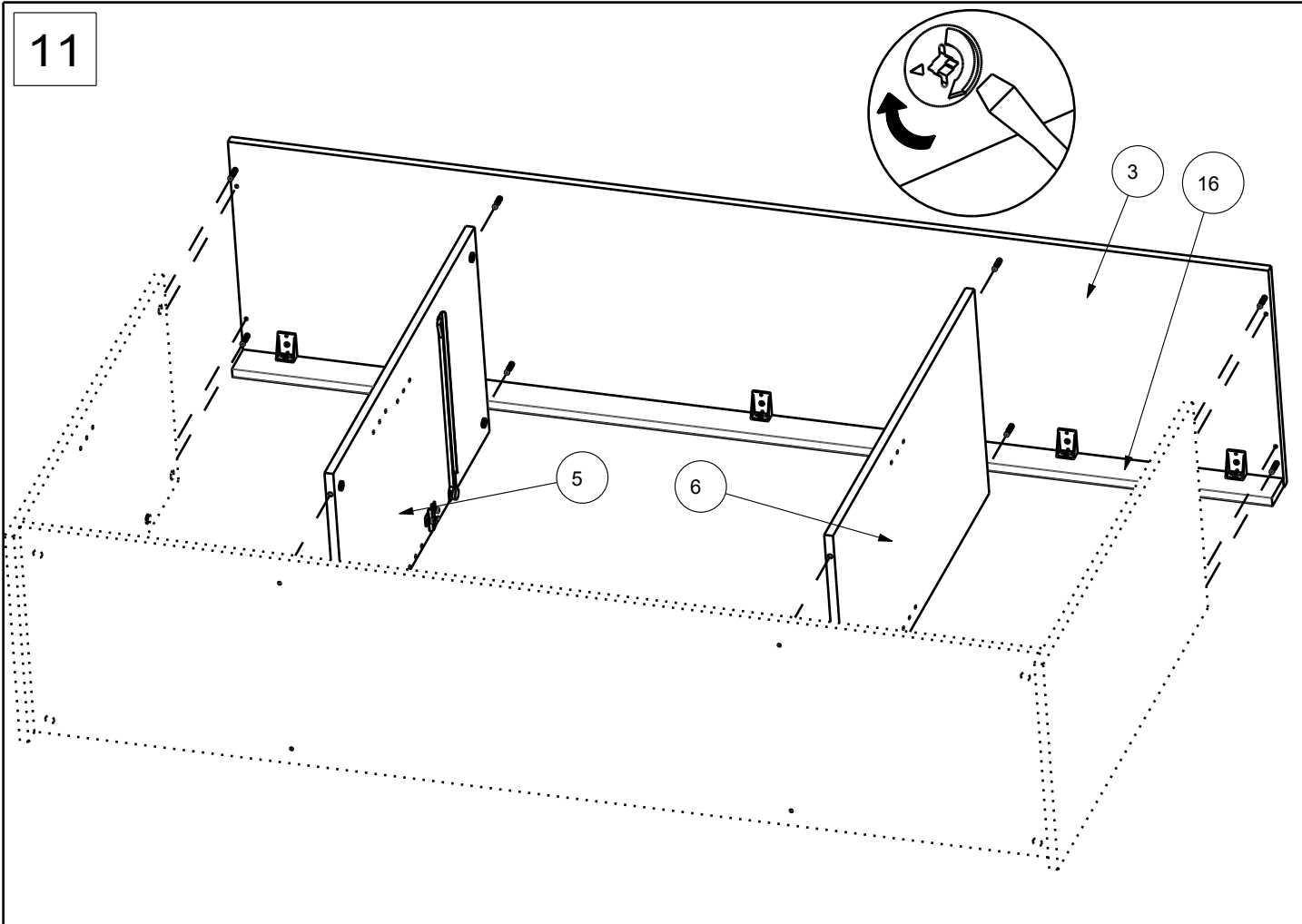

11



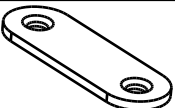

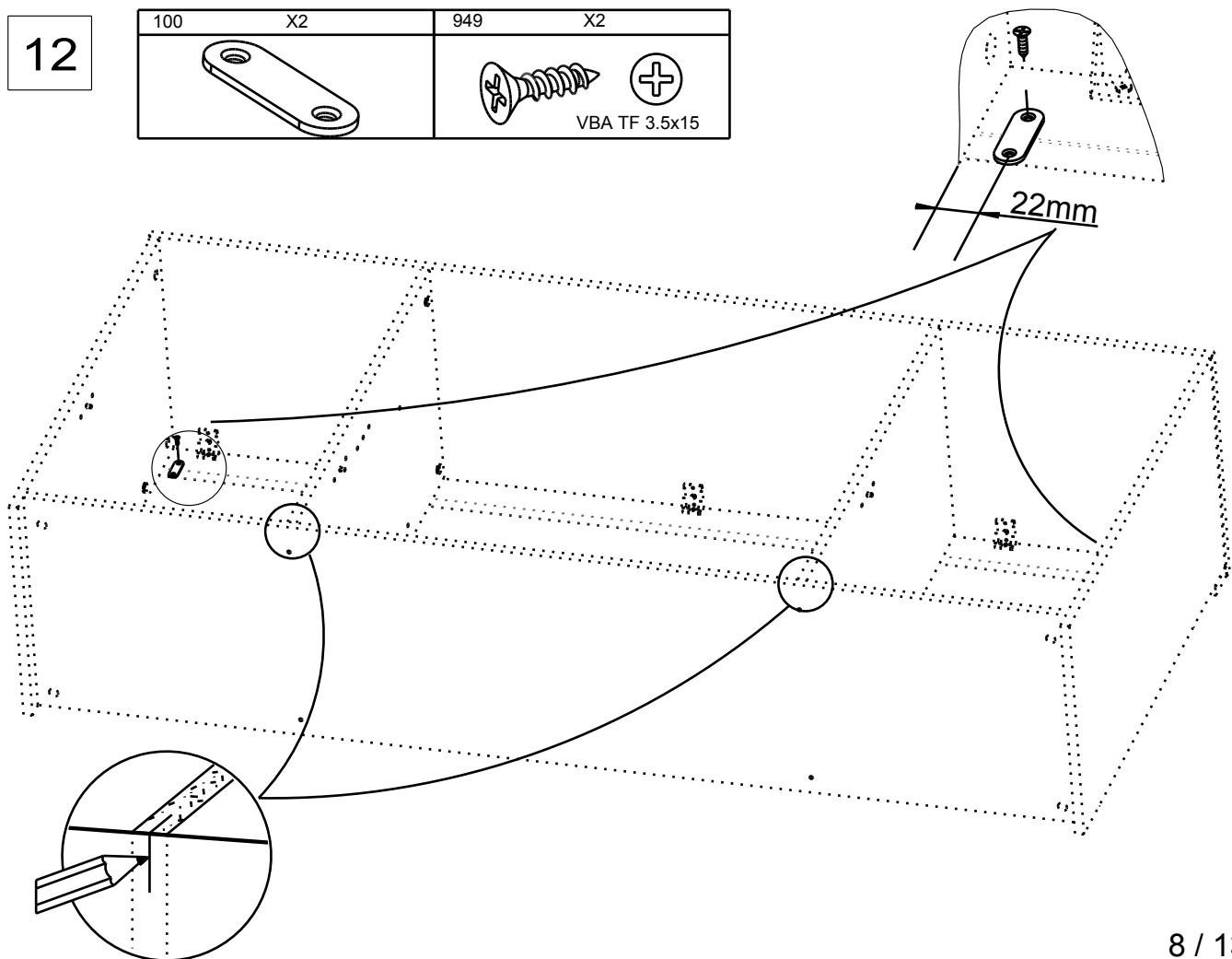

12

100	X2	949	X2
			
		VBA TF 3.5x15	



13

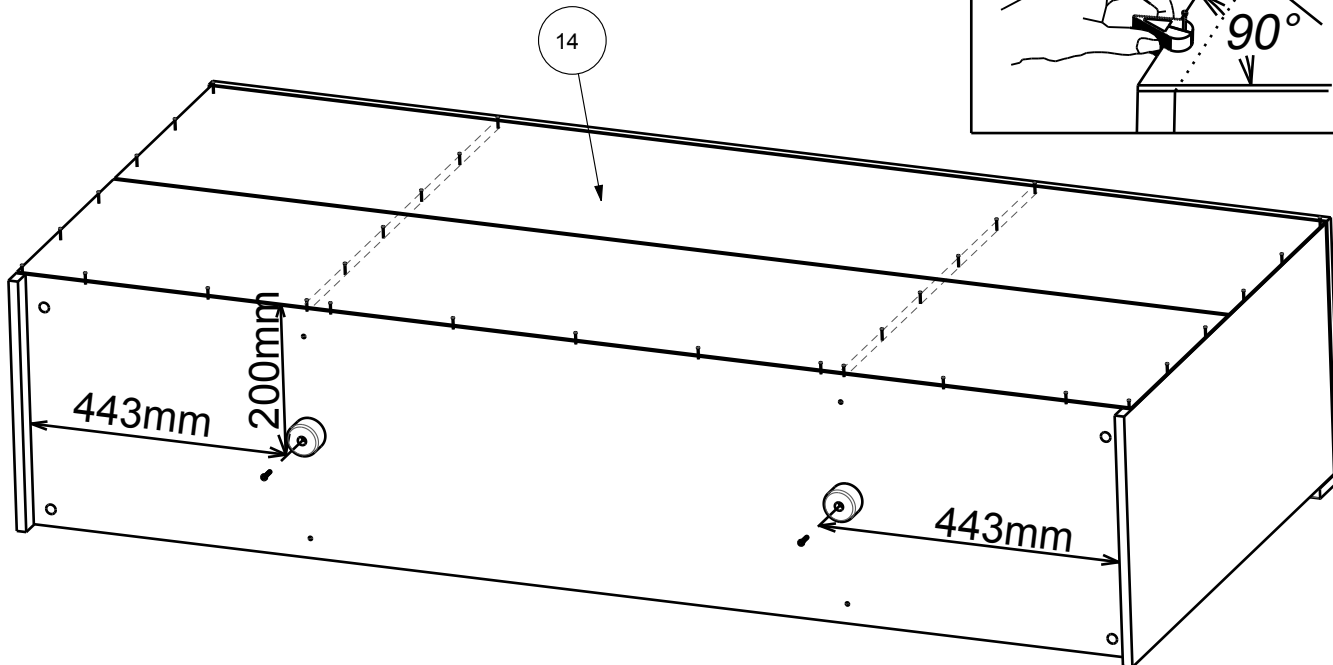
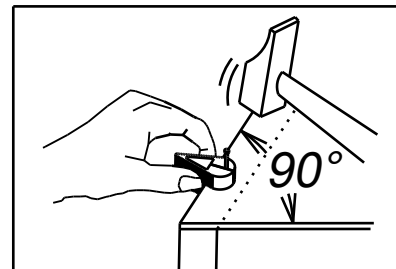

350041 X 2	918 X 2	331144 X 1	604757 X 1
 Ø 50 Ht 30 mm	 VBA TR 4v25		 x30

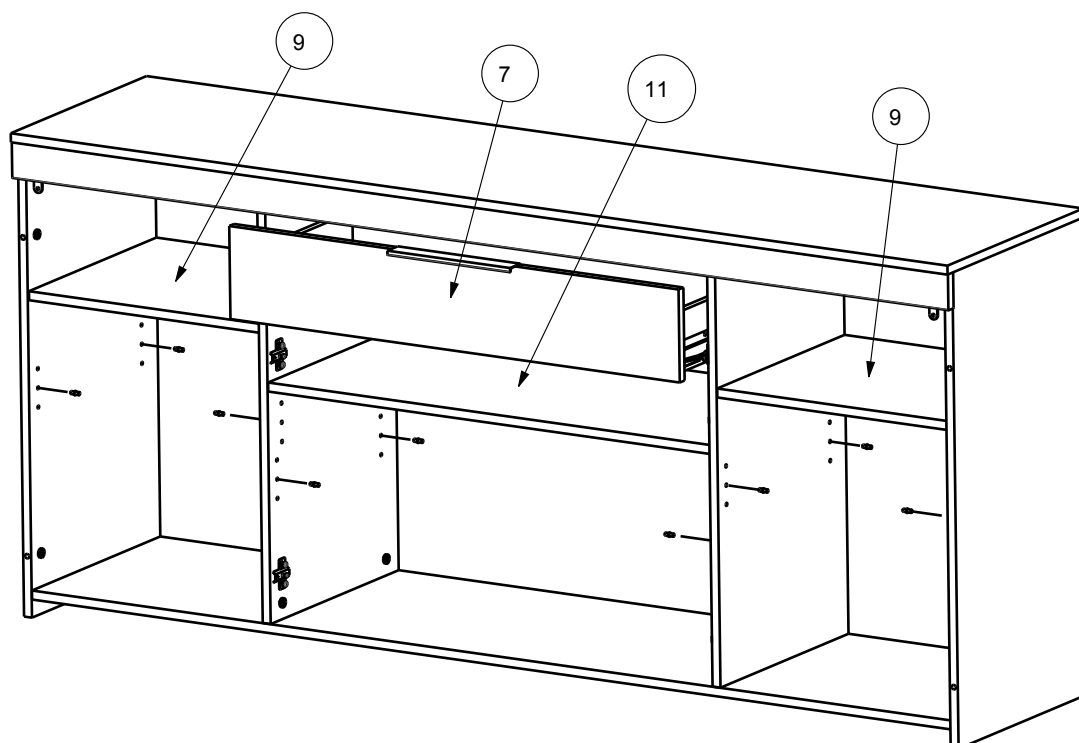
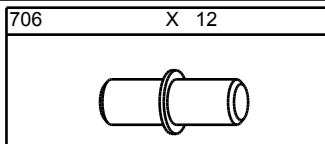

14



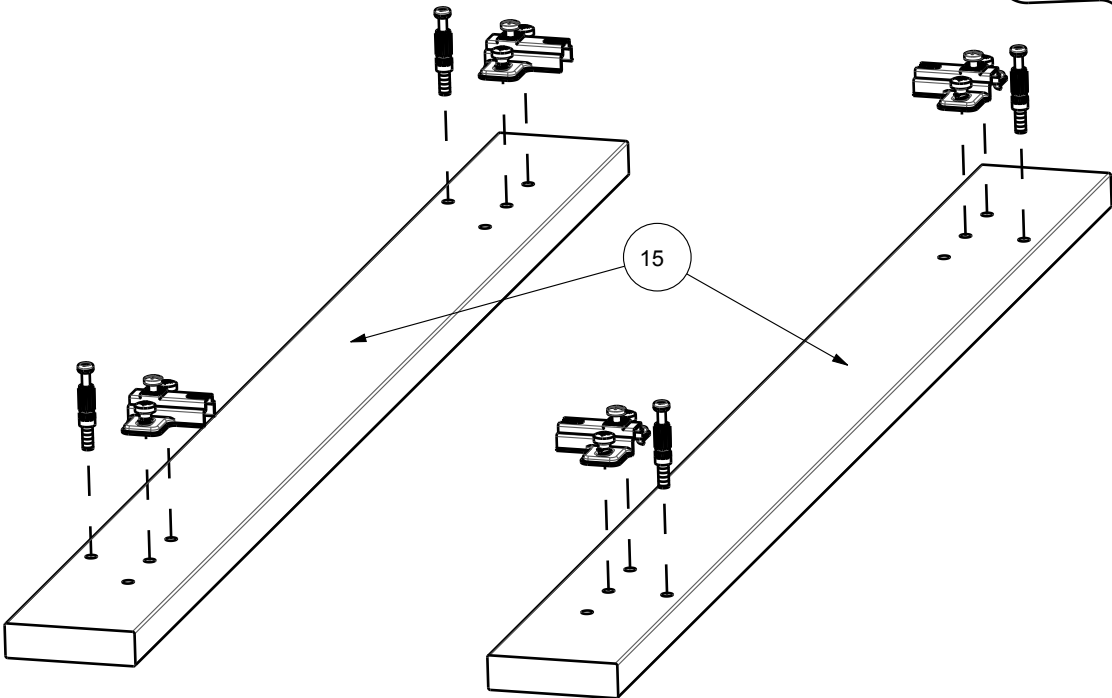
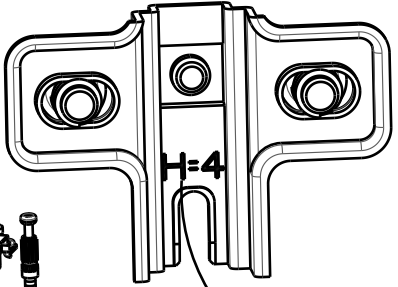

15

333019	X 4	70	X 4
			
H=4		ø5 x 39	

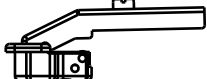

15

16

333079	X 4	949	X 8
		 	
VBA TF 3.5x15			

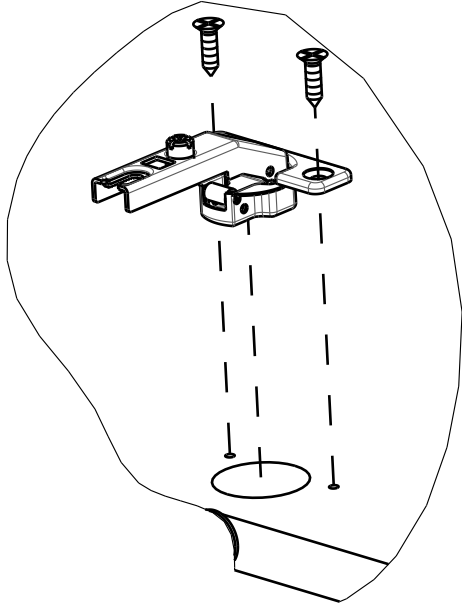

8

X2

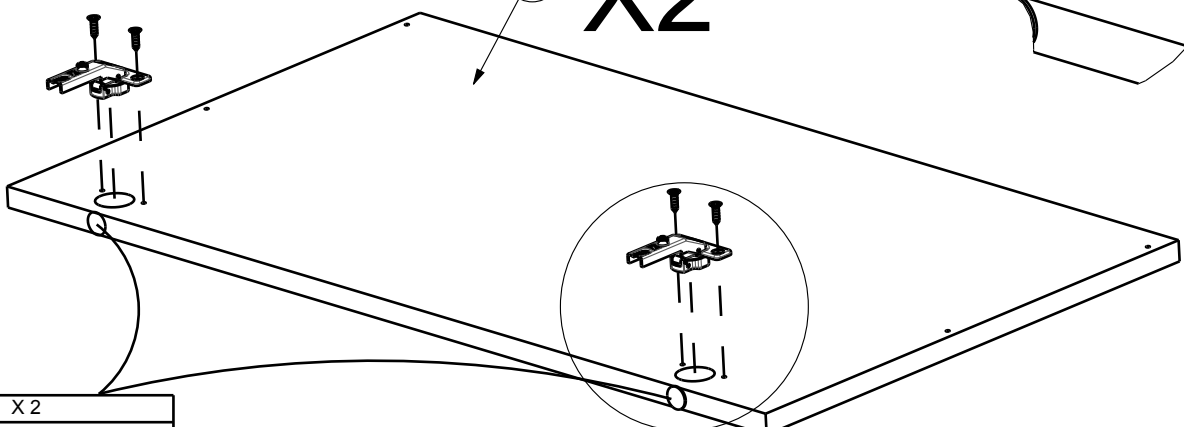

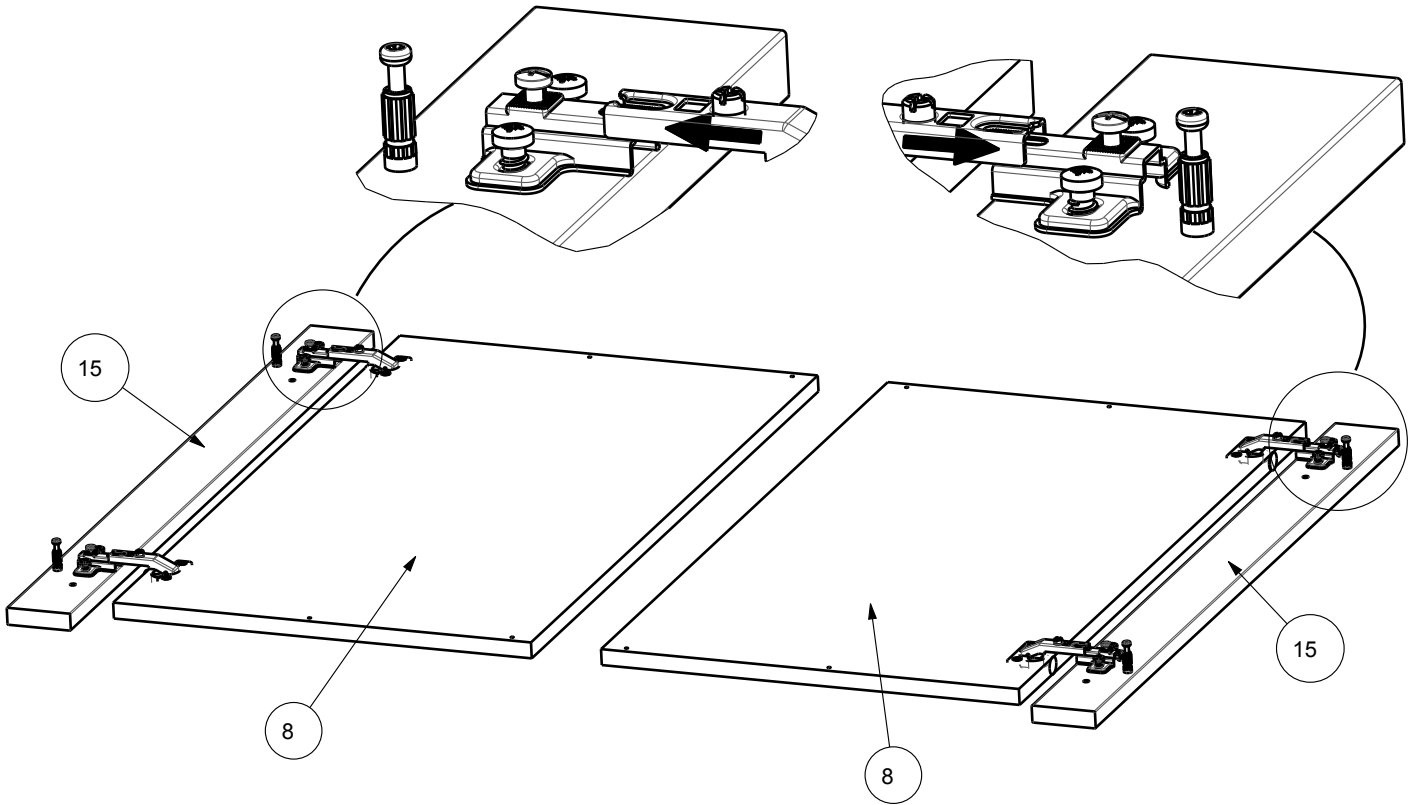

8930	X 2
	

17

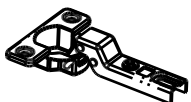

18

333011	X 4	949	X 8
			
		VBA TF 3.5x15	

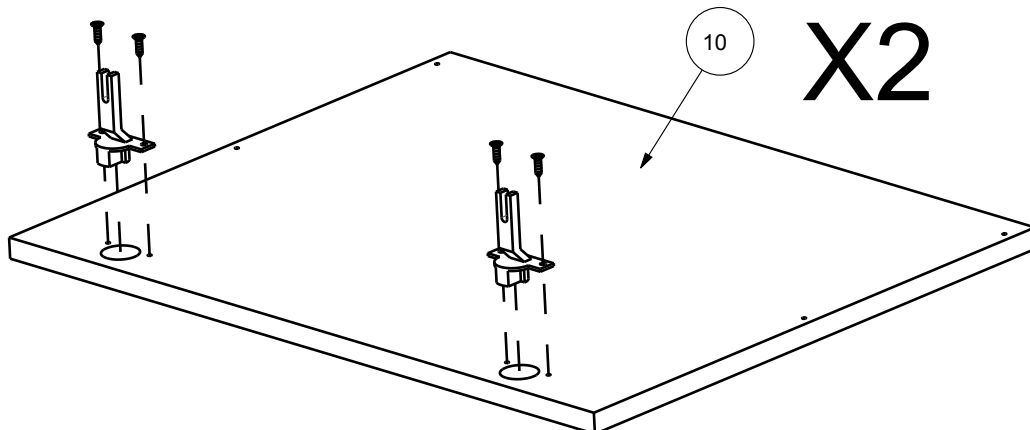

19

