

Demeyere

SAV
SPAREPARTS
KUNDEDIENST
POST VENTAS
SERVICE NA VERKOOP
SERVIZIO POST-VENDITA
SERVICO DEPOIS DE VENDA
SERWIS POGWARANCYJNY

5700 2

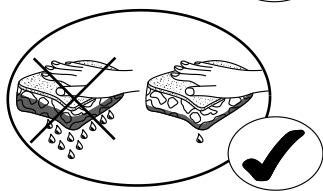
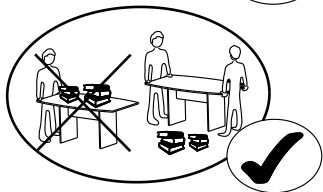
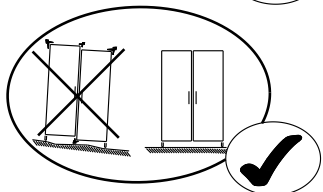
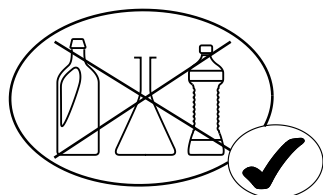

REP	DIM	QTE
1	1695 x 501	1
2	1695 x 501	1
3	767 x 500	2
4	767 x 91	1
5	1595 x 388	2
6	767 x 388	1
7	1600 x 397	2

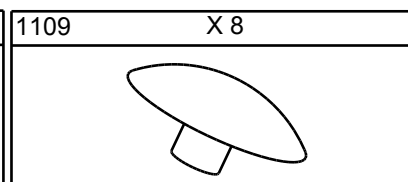
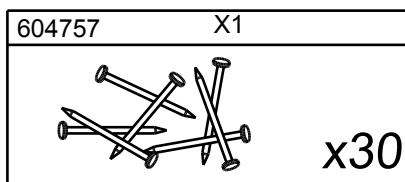
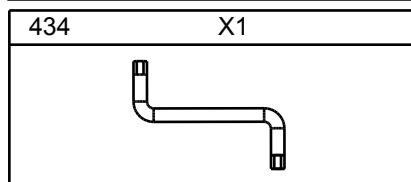
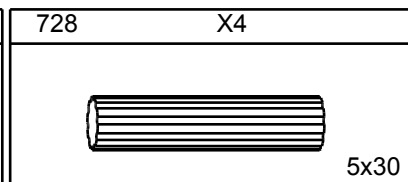
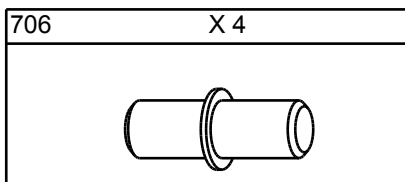
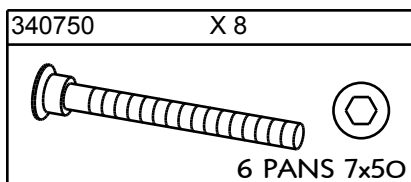
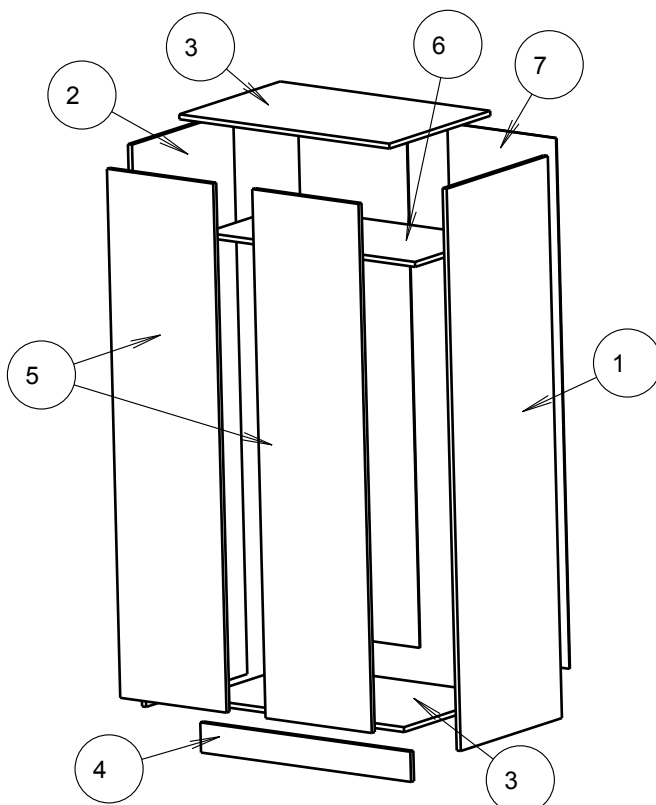

± **OH** 45MN

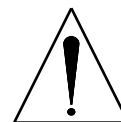

(FR) SECURITE
RESPECTER LES INSTRUCTIONS DE MONTAGE DECRITES DANS LA NOTICE.

(EN) CAUTION
FOLLOW CAREFULLY THE ASSEMBLING INSTRUCTIONS DESCRIBED IN THE DIRECTIONS.

(DE) SICHERHEITSVORSCHRIFTEN
BEACHTEN SIE BITTE UNBEDINGT DIE ANGEGEBENEN AUFBAUVORSCHRIFTEN.

(ES) SEGURIDAD
RESPECTAR LAS INSTRUCCIONES DE MONTAJE DESCRIBIDAS EN EL FOLLETO.

(NL) VEILIGHEID
DE IN DE GEBRUIKSAANWIJZING BESCHREVEN INSTRUCTIES RESPECTEREN.

(IT) SICUREZZA
RISPETTARE LE ISTRUZIONI DI MONTAGGIO DESCRITTE NELL'AVVERTENZA.

(PT) SEGURANCA
RESPEITAR AS INSTURAÇÕES DE MONTAGEM DESCRÉVIDAS NA INSTRUÇÕES DE USO.

(PL) UWAGA
PROSZĘ PRZESTRZEGAĆ INSTRUKCJI MONTAŻU.

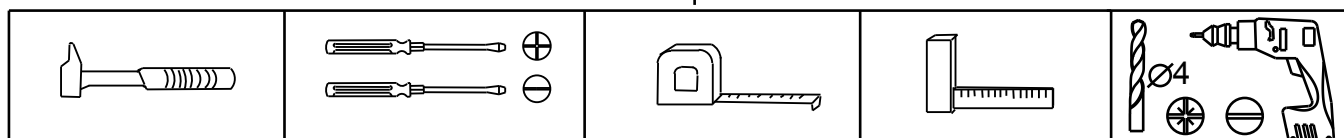

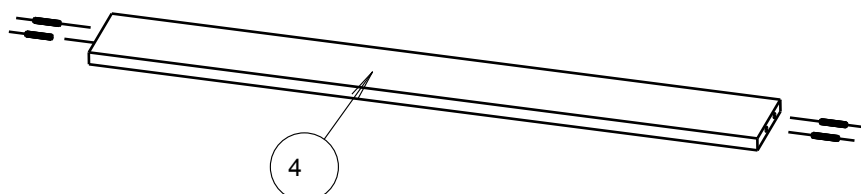
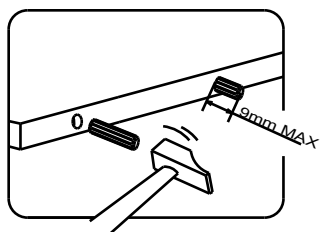
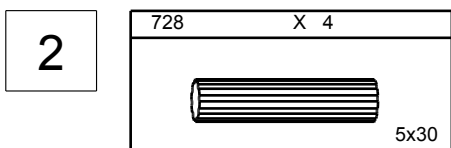
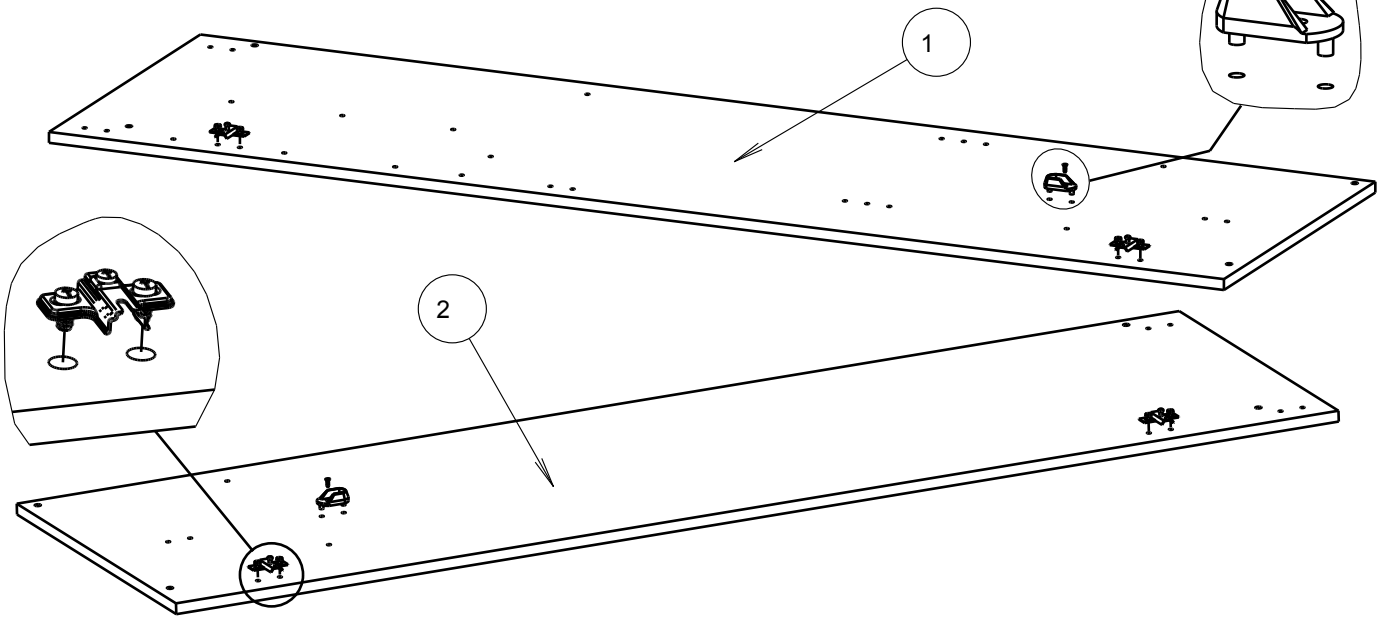
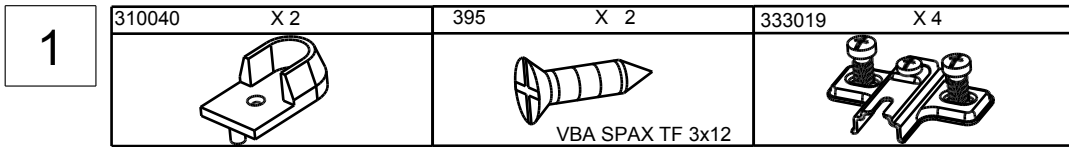
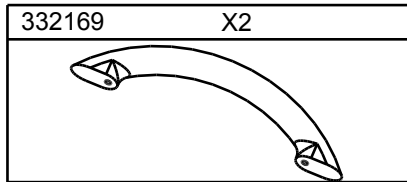
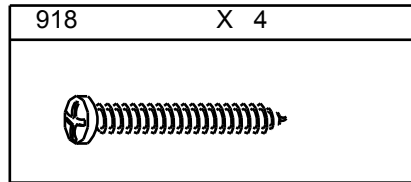
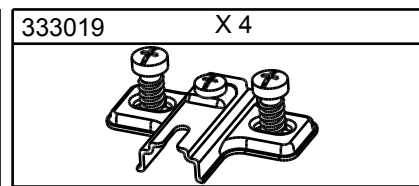
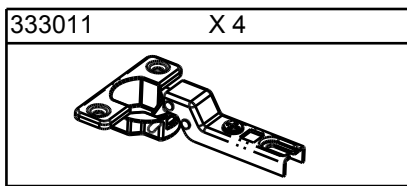
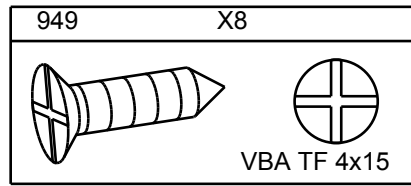
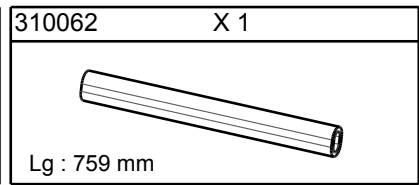
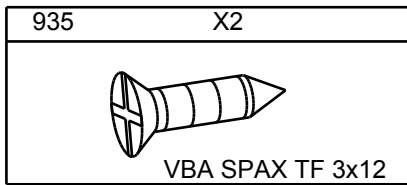
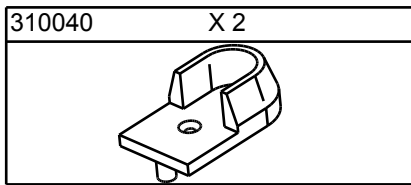

3

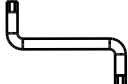
340750	X 8	434	X1
 <p>6 PANS 7x50</p>			

604757	X1
 <p>x30</p>	

5700 2 11-Jun-10

4

13622	X1
	

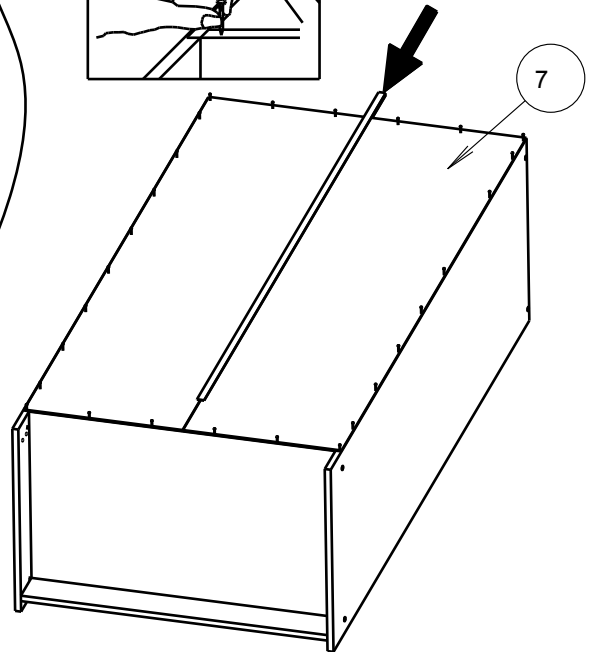
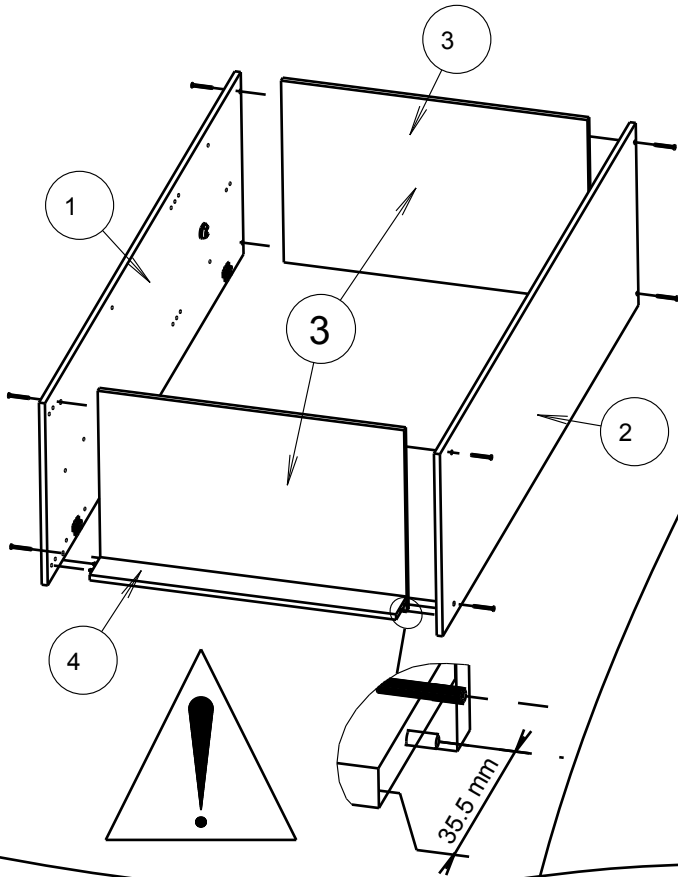
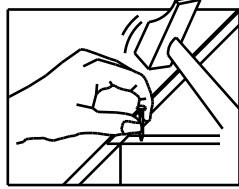
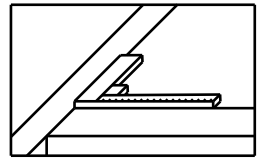

5

706	X 4
	

310062	X 1
 <p>Lg : 759 mm</p>	

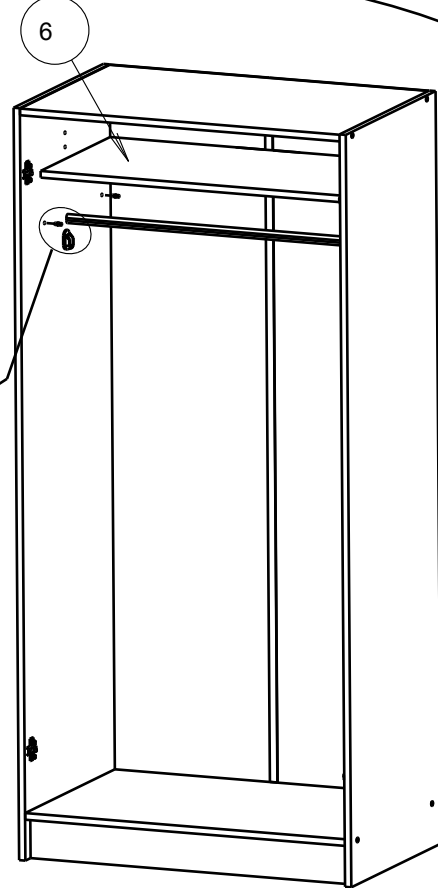
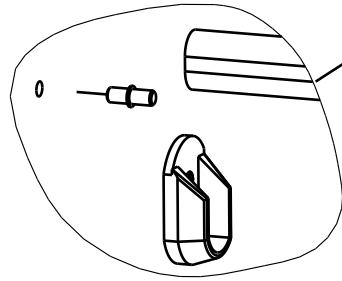

6

333011 X 4

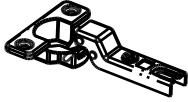

949 X8

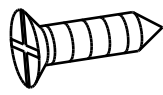

918 X 4



5700 2 11-Jun-10

332169 X2

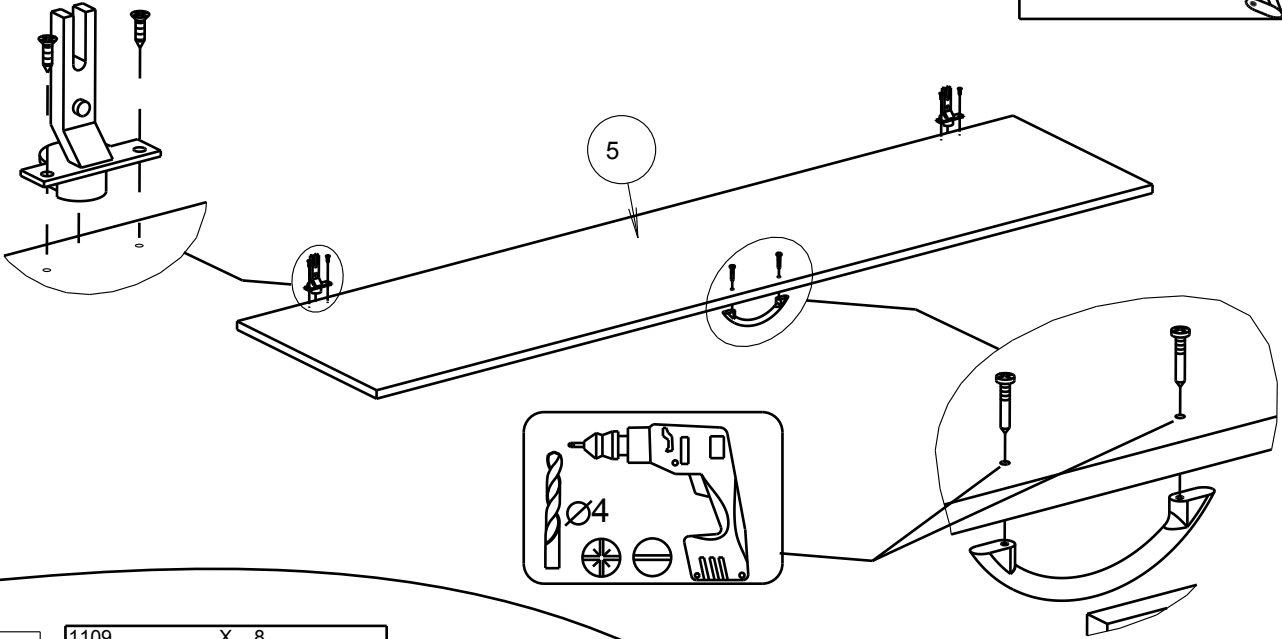
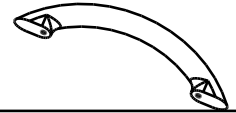

7

1109 X 8

