

REP	DIM	QTE
1	1622 x 499	2
2	812 x 500	2
3	1636 x 395	2
4	780 x 395	1
5	1648 x 808	1

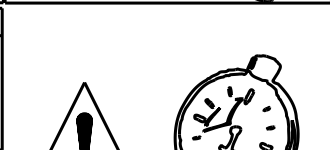

**1H00MN**

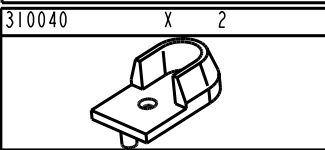
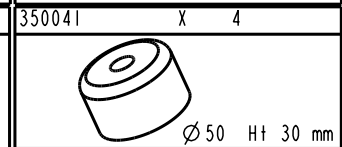
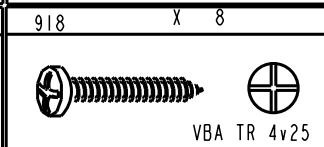
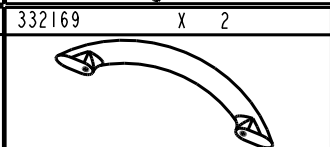
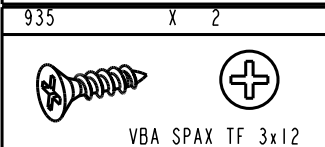
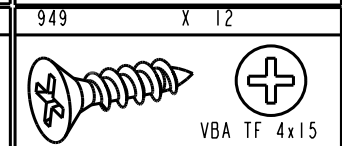
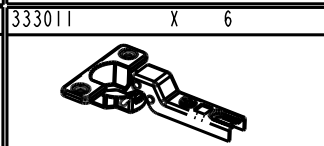
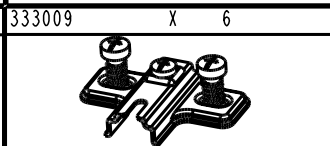
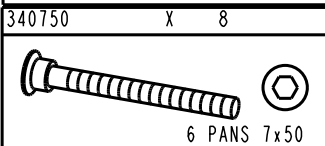
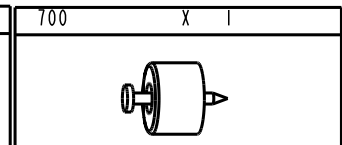
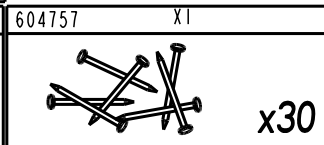
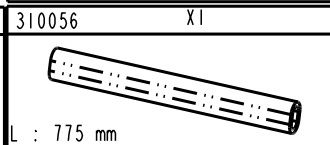
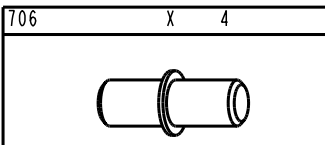
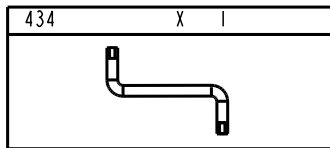
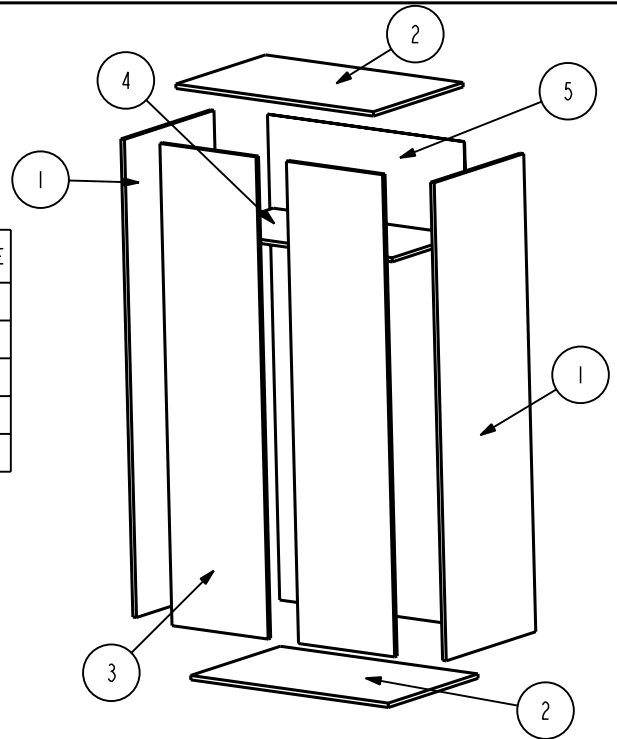

**(FR) SECURITE**  
RESPECTER LES INSTRUCTIONS DE MONTAGE DECRITES DANS LA NOTICE.

**(EN) CAUTION**  
FOLLOW CAREFULLY THE ASSEMBLING INSTRUCTIONS DESCRIBED IN THE DIRECTIONS.

**(DE) SICHERHEITSVORSCHRIFTEN**  
BEACHTEN SIE BITTE UNBEDINGT DIE ANGEGBENEN AUFBAUVORSCHRIFTEN.

**(ES) SEGURIDAD**  
RESPECTAR LAS INSTRUCCIONES DE MONTAJE DESCRIBIDAS EN EL FOLLETO.

**(NL) VEILIGHEID**  
DE IN DE GEBRUIKSAANWIJZING BESCHREVEN INSTRUCTIES RESPECTEREN.

**(IT) SICUREZZA**  
RISPETTARE LE INSTRUZIONI DI MONTAGGIO DESCRITTE NEEL 'AVVERTENZA.

**(PT) SEGURANCA**  
RESPEITAR AS INSTURACOS DE MONTAGEM DESCRVEDAS NA INSTRUCOES DE USO.

**(PL) UWAGA**  
PROSZE, PRZESTRZEGAC INSTRUKCJI MONTAZU.

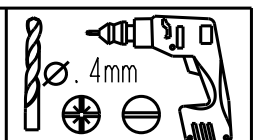
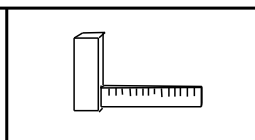
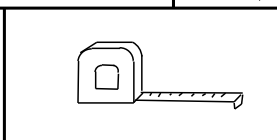
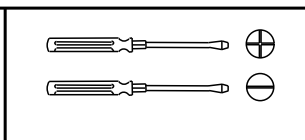
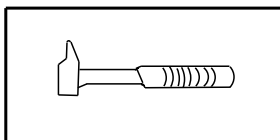

1

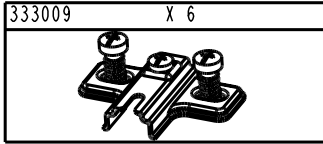

X 2

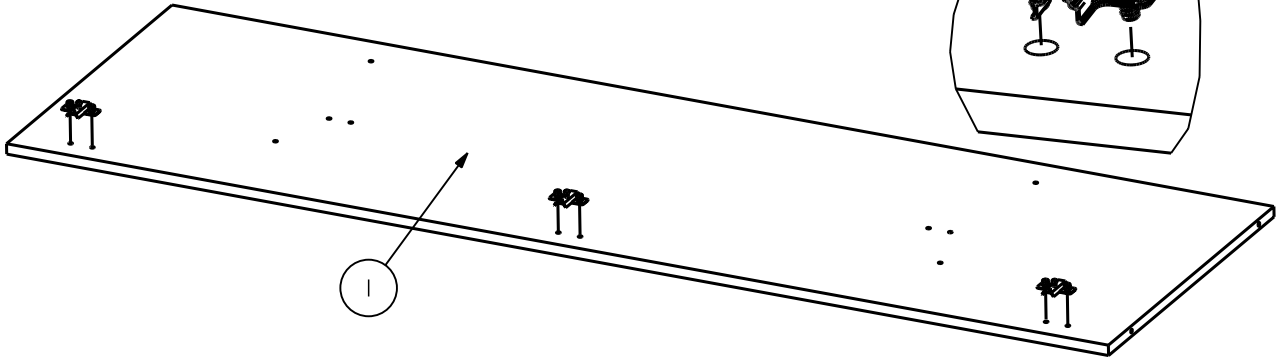
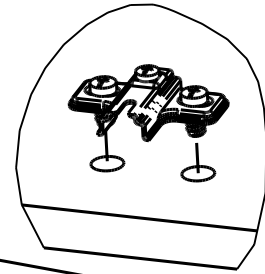

2

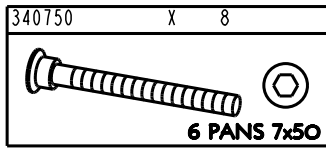

6 PANS 7x50

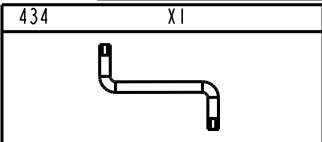
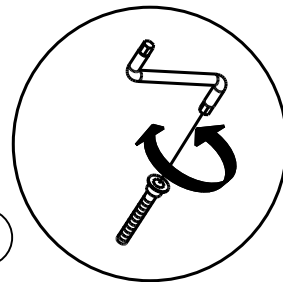

45,5 mm

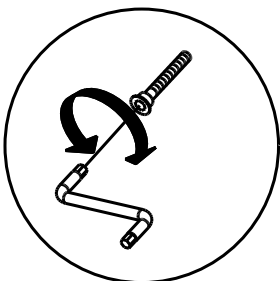
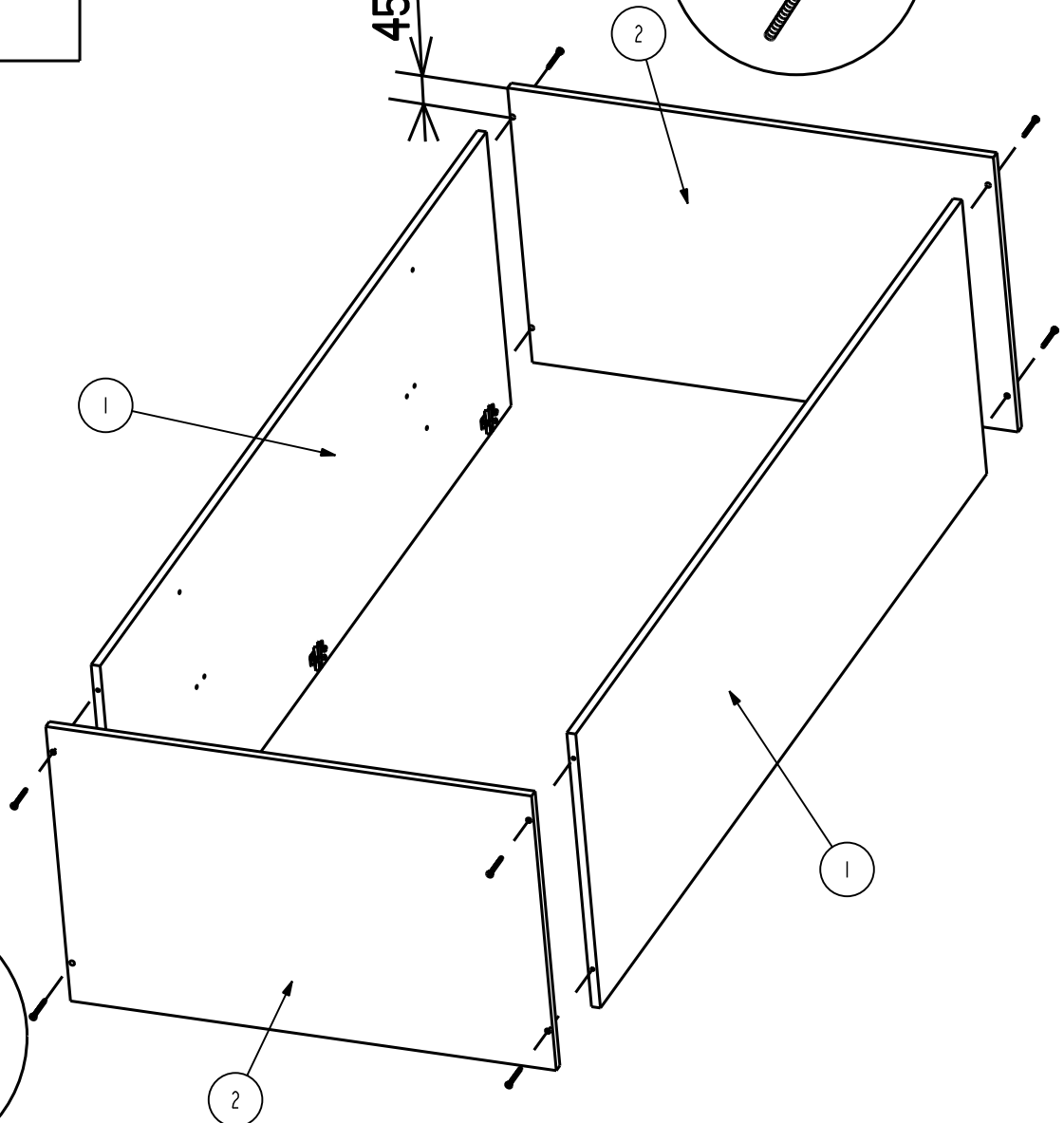

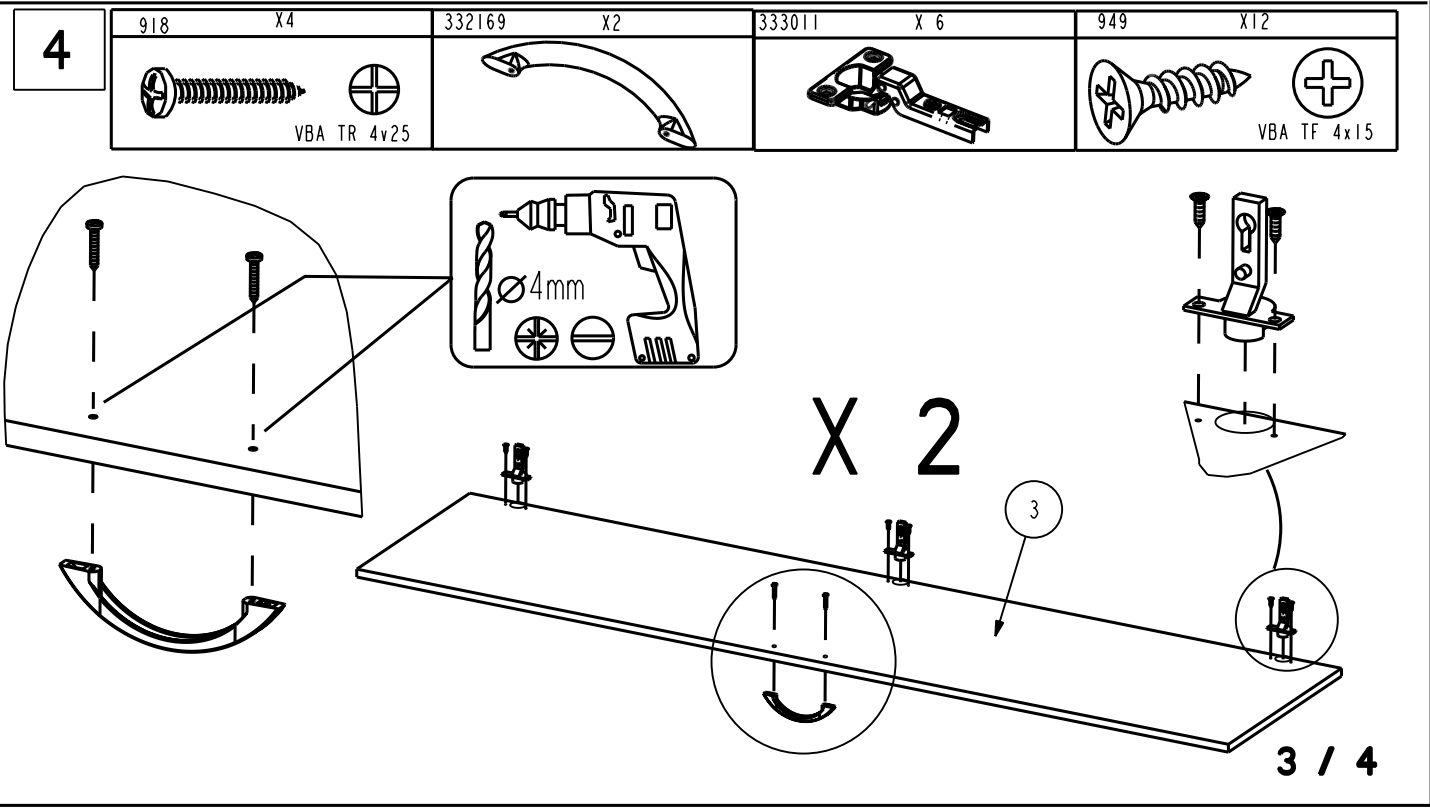
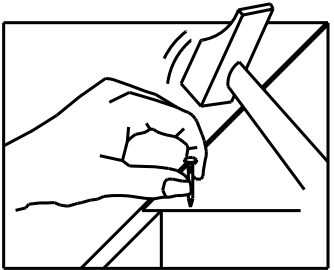
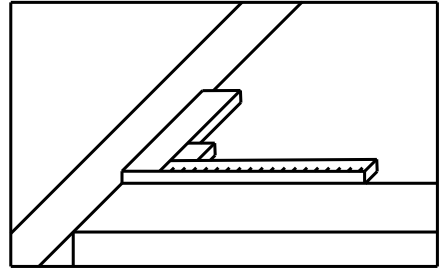
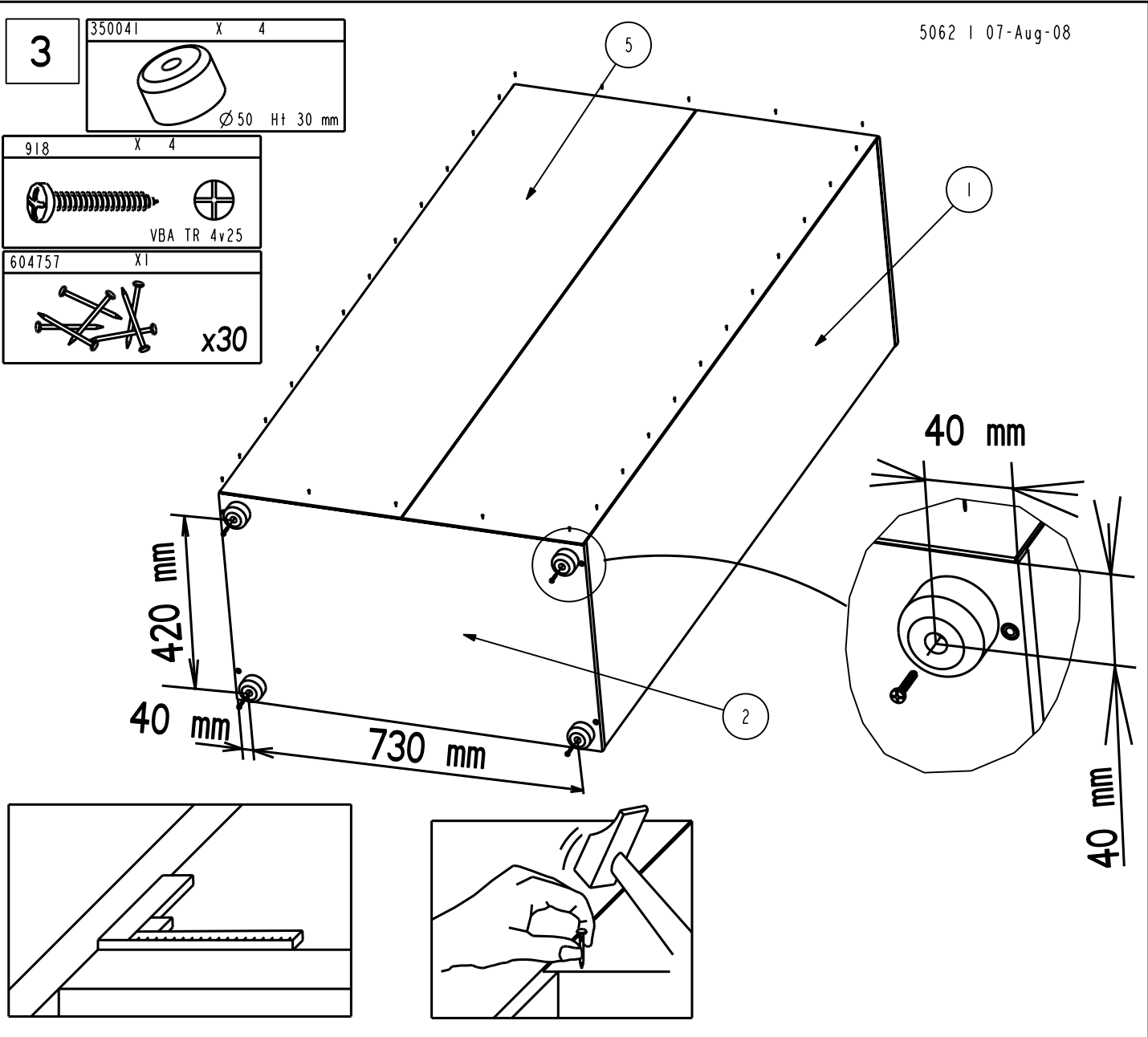

5

700 X 1

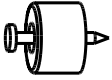

706 X 4

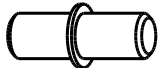

935 X 2



VBA SPAX TF 3x12

310040 X 2



310056 X1

L : 775 mm

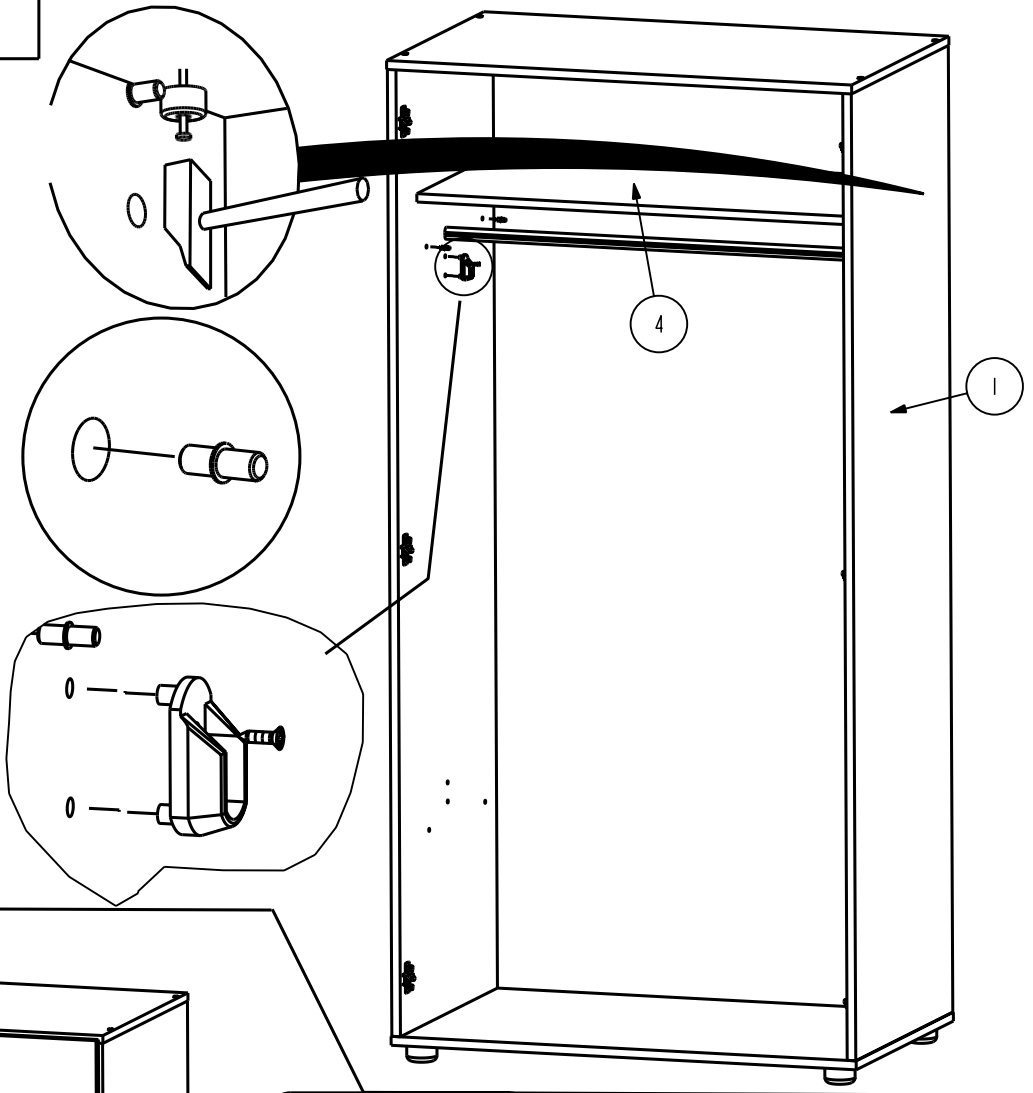
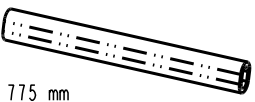

6

