

SAV  
SPAREPARTS  
KUNDEDIENST  
POST VENTAS  
SERVICE NA VERKOOP  
SERVIZIO POST-VENDITA  
SERVICO DEPOIS DE VENDA  
SERWIS POGWARANCYJNY

# 305676 0

**FR** MEUBLES A FIXER AU MUR:  
- FIXER LE MEUBLE AU MUR AVEC LES ATTACHES PREVUES A CET EFFET  
- VERIFIER QUE LES VIS ET LES CHEVILLES UTILISEES SONT ADAPTEES AU SUPPORT

**ES** MUEBLES A FIJAR EN LA PARED:  
- FIJAR EL MUEBLE EN LA PARED CON LAS GRAPAS PREVISTAS  
- COMPROBAR QUE LOS TORNILLOS Y LAS CLAVIJAS UTILIZADAS SON ADAPTADAS AL SOPORTE

**PT** MOVEIS A FIXAR NA PAREDE:  
- FIXAR O MOVEL NA PAREDE COM OS PRENDES PREVISTOS  
- VERIFICAR QUE OS PARAFUSOS E AS CAVILHAS UTILIZADOS SAO ADAPTADOS OA SUPORTE

**EN** FURNITURES TO BE HOLD ON THE WALL:  
- HOLD THE FURNITURE ON THE WALL WITH THE FASTENINGS PROVIDED FOR THIS PURPOSE  
- CHECK THAT THE SCREW AND PEGS FIT WITH THE SUPPORT

**IT** MOBILI DA FISSARE AL MURO:  
- FISSARE IL MOBILE AL MURO CON LE FLANGIE PREVISTE A TALE SCOPO  
- VERIFICARE CHE LE VITI ED I PERNI USATI SIANO ADATTI A QUEL TIPO DI SUPPORTO

**PL** MEBEL PRZEZNACZONY DO ZAINSTALOWANIA NA SCIANIE:

- NALEŻY ZAMONTOWAC TEN MEBEL NA SCIANIE PRZEZNACZONYMI DO TEGO CELU UCHWYTAMI  
- NALEŻY SPRAWDZIĆ CZY ŚRUBY I KOSZULKI SĄ ODPOWIEDNIEJ WIELKOŚCI W STOSUNKU DO UCHWYTÓW

**DE** MOEBEL AN DER MAUER ZU BEFESTIGEN:  
- BEFESTIGEN SIE DAS MOEBELSTUECK MIT DEN DAFUER VORGEGEHENEN BEFESTIGUNGSHAKEN  
- UEBERPRUEFEN SIE BITTE DASS DIE SCHRAUBEN UND DUEBEL MIT DEM MATERIAL DER MAUER UEBEREINSTIMMEN

**NL** MEUBELS DIE AAN DE MUUR GEFIXEERD MOETEN WORDEN:  
- FIXEER HET MEUBEL AAN DE MUUR MET DE DAARVOOR BESTEMDE HAKEN  
- VERFIEER OF DE GEBRUIKTE SCHROEVEN BIJ DE BEVESTIGINGSHAAK HOREN

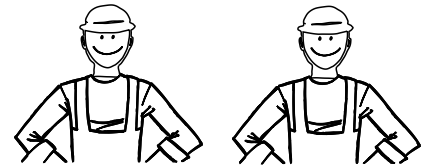

## 1H 30MN

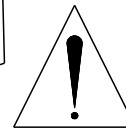
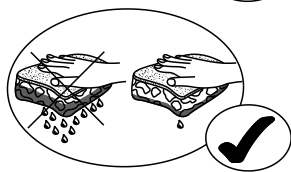
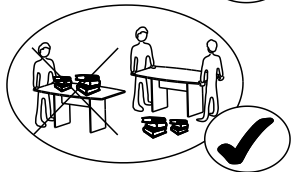
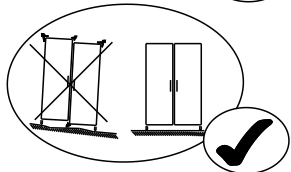
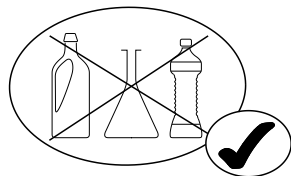

**FR** SECURITE  
RESPECTER LES INSTRUCTIONS DE MONTAGE DECRITES DANS LA NOTICE.

**EN** CAUTION  
FOLLOW CAREFULLY THE ASSEMBLING INSTRUCTIONS DESCRIBED IN THE DIRECTIONS.

**DE** SICHERHEITSVORSCHRIFTEN  
BEACHTEN SIE BITTE UNBEDINGT DIE ANGEGEBENEN AUFBAUVORSCHRIFTEN.

**ES** SEGURIDAD  
RESPECTAR LAS INSTRUCCIONES DE MONTAJE DESCRIBIDAS EN EL FOLLETO.

**NL** VEILIGHEID  
DE IN DE GEBRUIKSAANWIJZING BESCHREVEN INSTRUCTIES RESPECTEREN.

**IT** SICUREZZA  
RISPETTARE LE INSTRUZIONI DI MONTAGGIO DESCRITTE NEEL AVVERTENZA.

**PT** SEGURANCA  
RESPEITAR AS INSTURACOS, DE MONTAGEM DESCRVEDAS NA INSTRUCOES DE USO.

**PL** UWAGA  
PROSZE, PRZESTRZEGAC INSTRUKCJI MONTAZU.

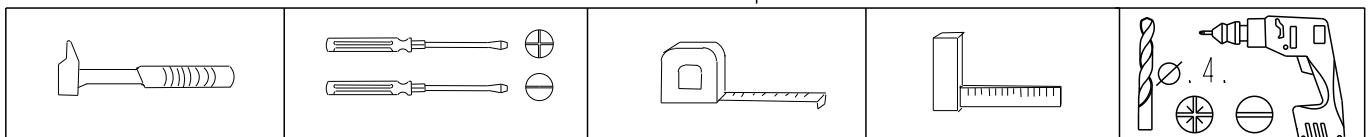

REP	DIM	QTE
1	2008 x 597	1
2	2008 x 597	1
3	1003 x 551	2
4	1003 x 59	2
5	1894 x 550	1
6	1915 x 500	1
7	494 x 549	2
8	1435 x 500	1
9	494 x 549	2
10	1003 x 59	1
11	500 x 155	3
12	440 x 486	3
13	471 x 438	3
14	1924 x 505	2

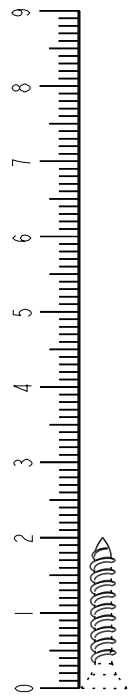
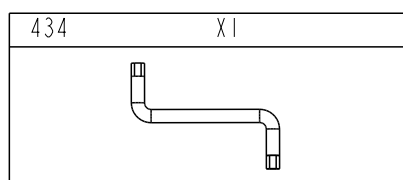
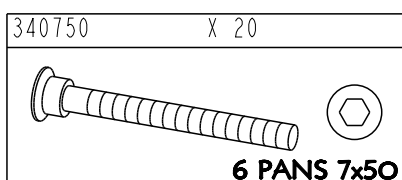
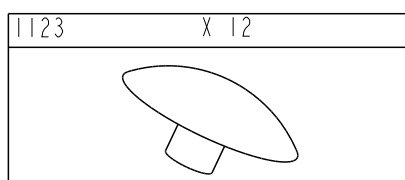
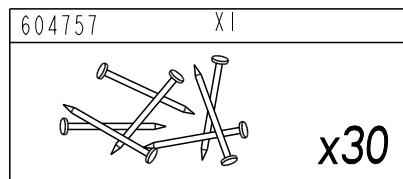
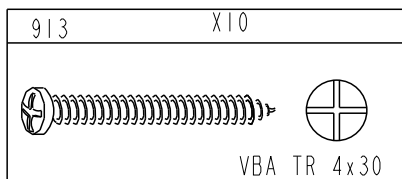
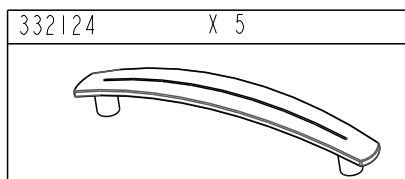
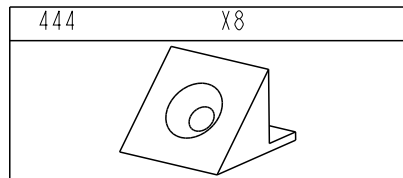
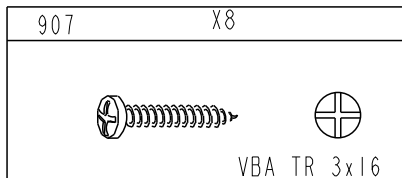
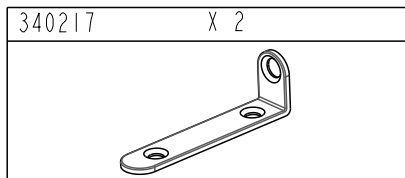
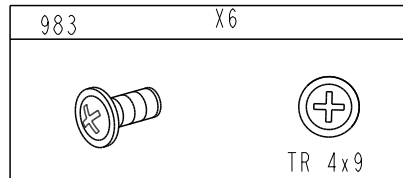
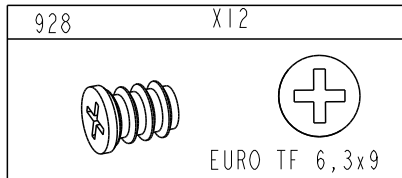
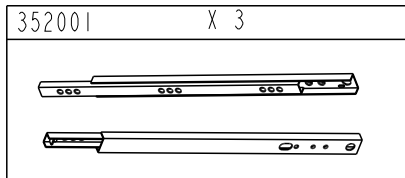
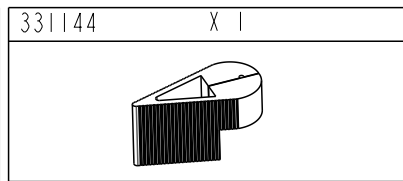
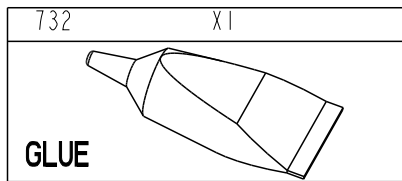
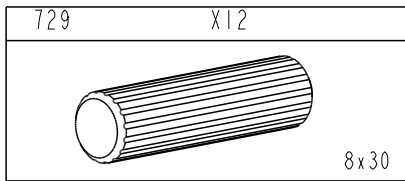
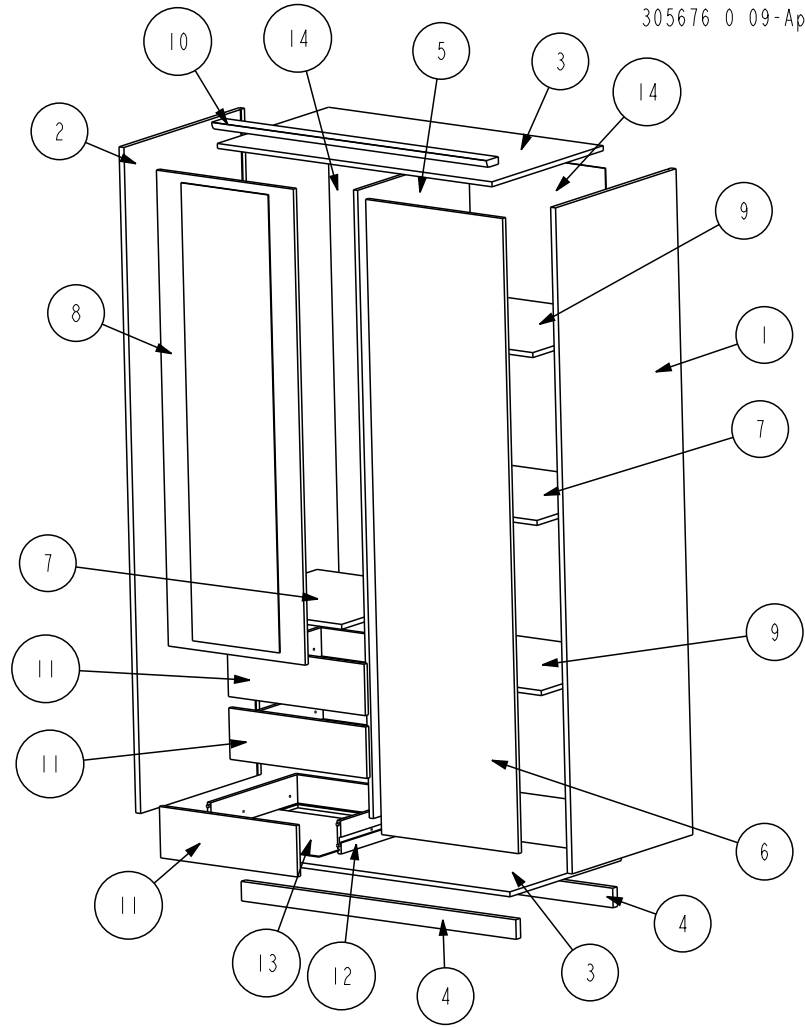

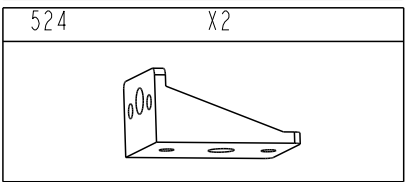
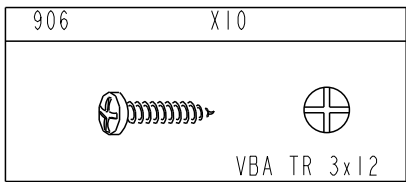
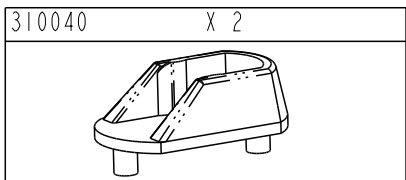
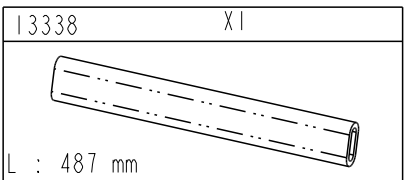
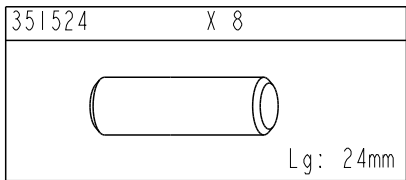
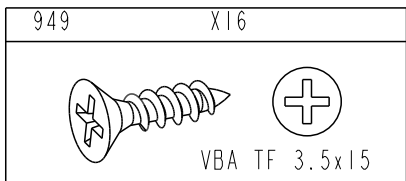
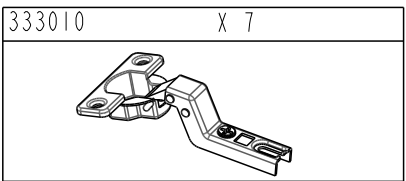
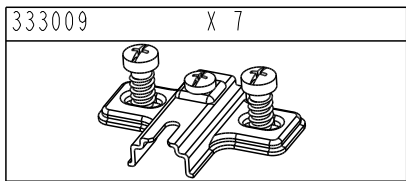
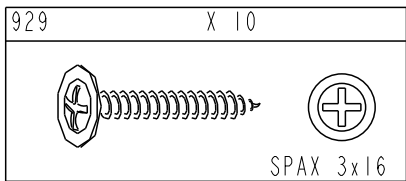
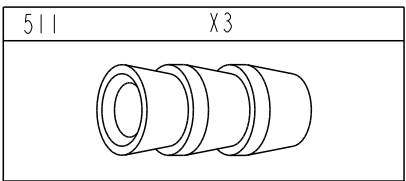
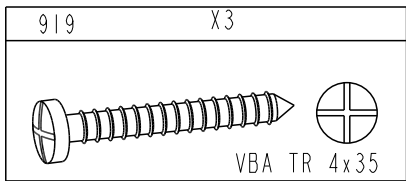

**1**

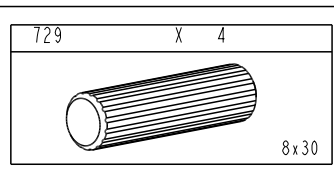
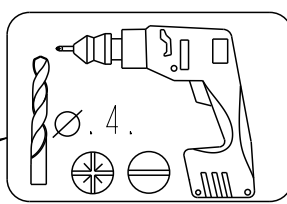
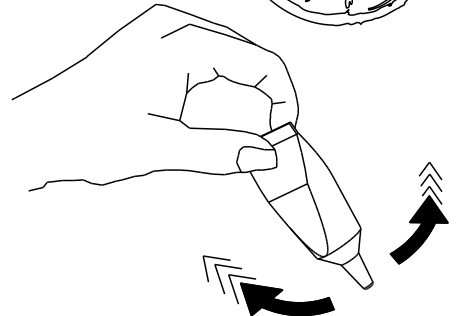
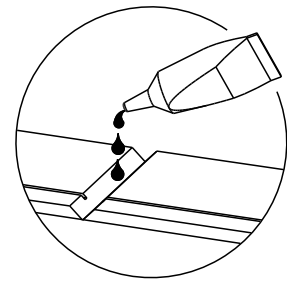
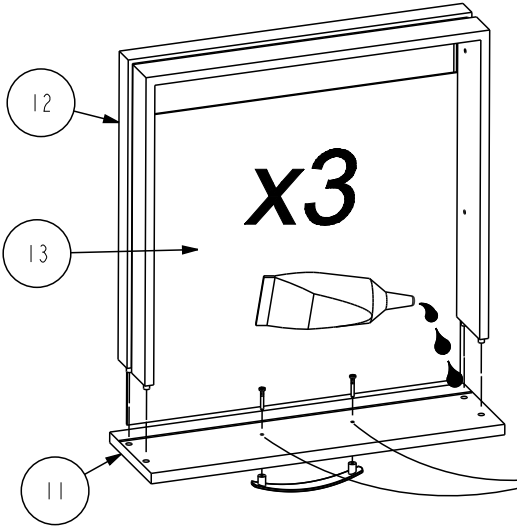
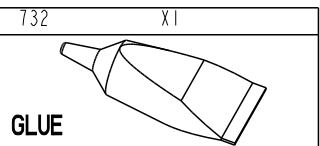
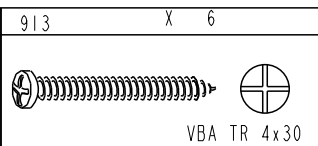
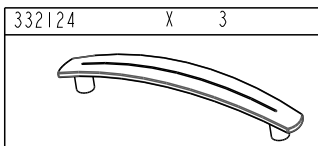

**2**

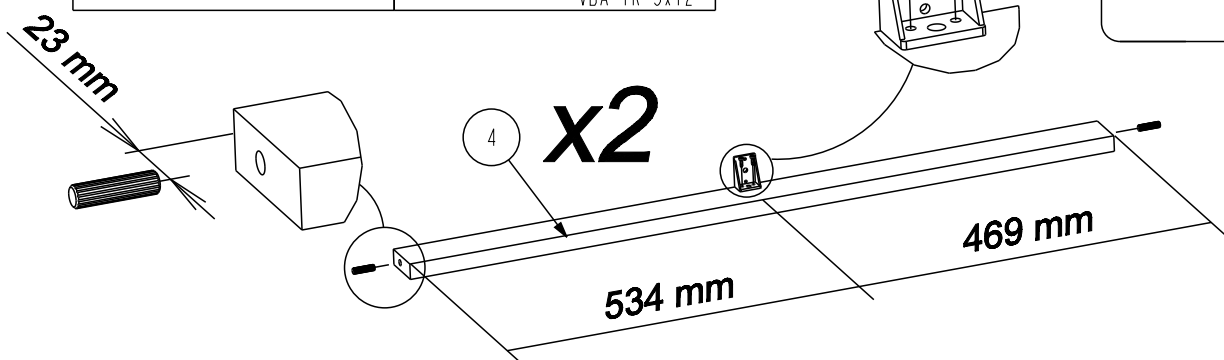
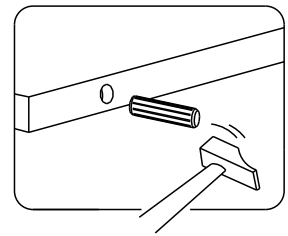
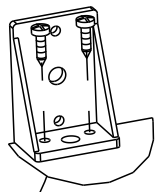
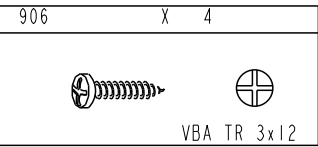
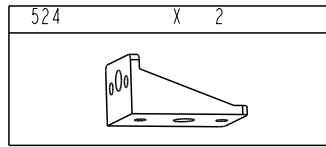

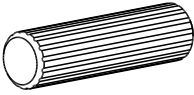
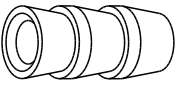
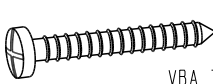

3

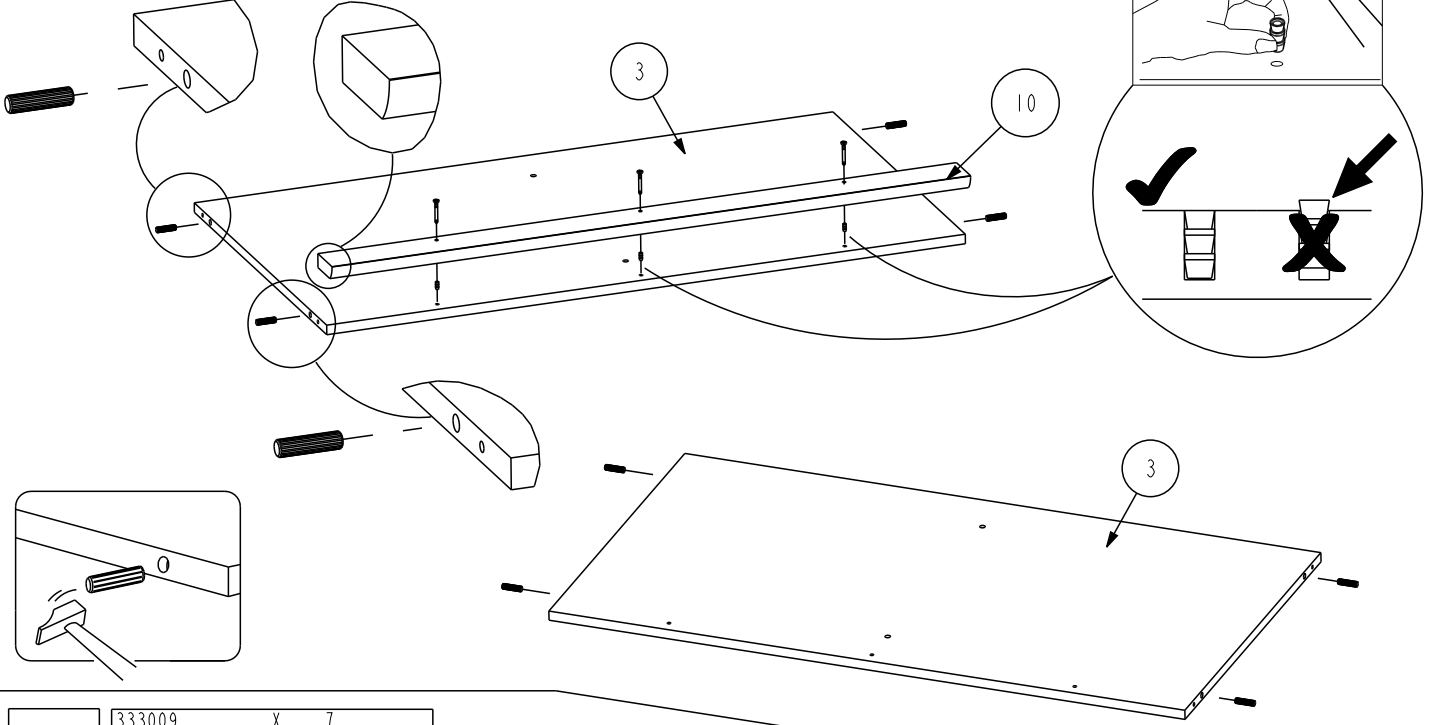
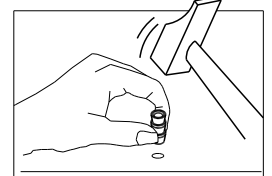
729 X 8	511 X 3	919 X 3
 8x30		 VBA TR 4x35

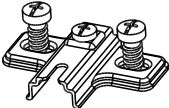

4

333009 X 7

352001 X 3
 

928 X 6
 EURO TF 6,3x9

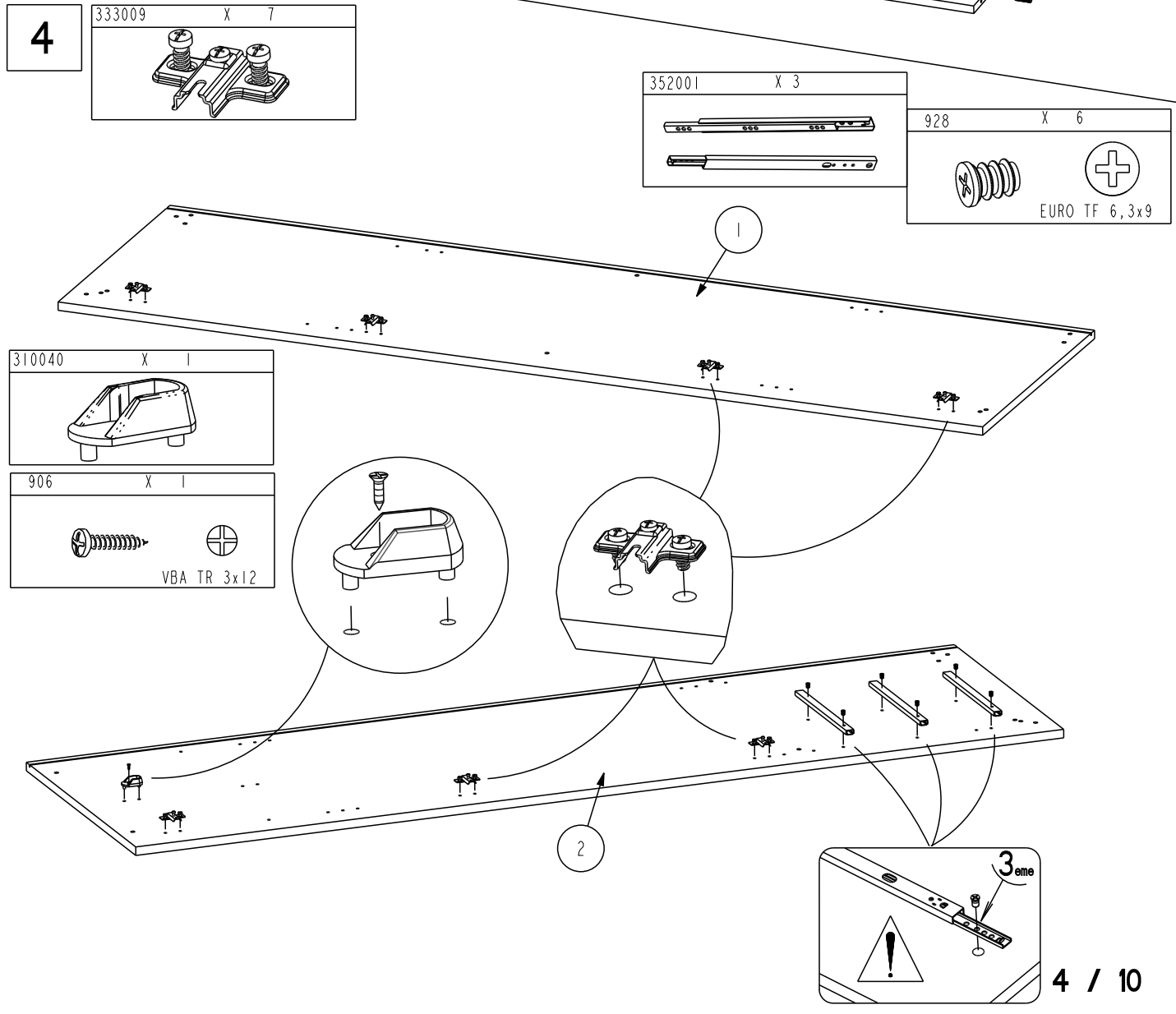

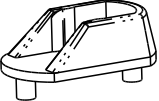
310040 X 1

906 X 1
 VBA TR 3x12

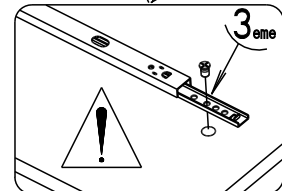

5

352001 X 3	928 X 6	310040 X 1
	 EURO TF 6,3x9	

305676 0 09-Apr-10
906 X 1
 VBA TR 3x12

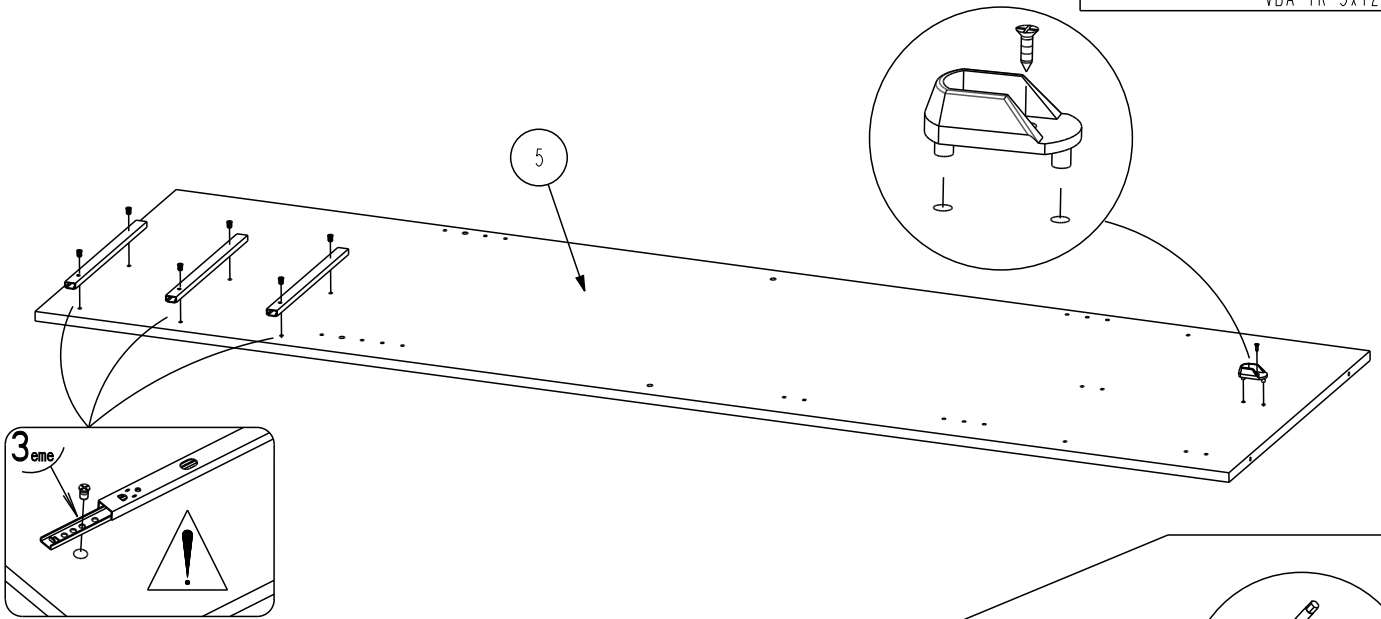

6

Face papier Paper Side Papierseite Lado papel	Papier zijde Lato nobilitato Lado papel Strona z papieru
--	---

434 X 1

340750 X 4
 6 PANS 7x50

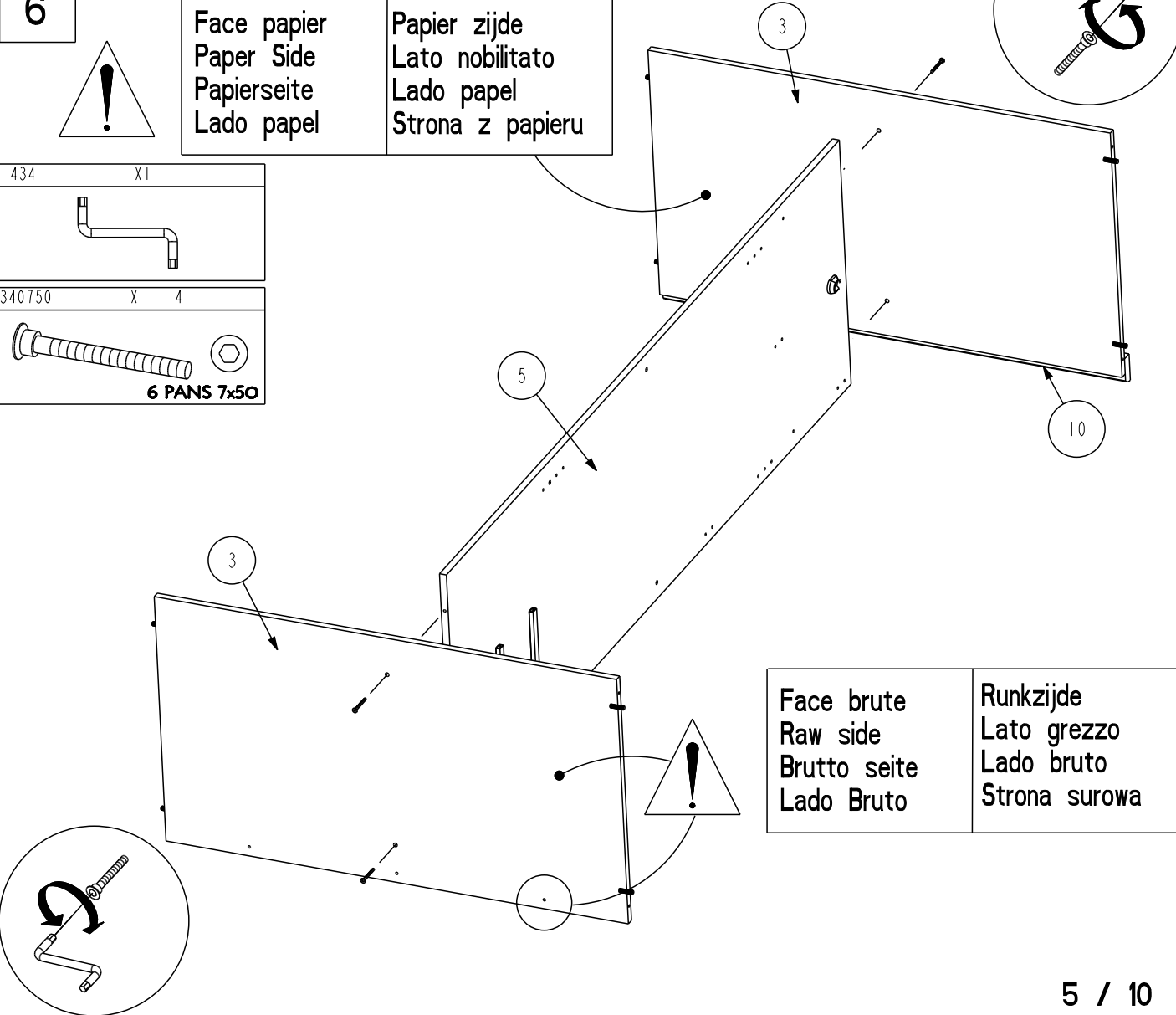

Face brute Raw side Brutto seite Lado Bruto	Runkzijde Lato grezzo Lado brutto Strona surowa
--	--

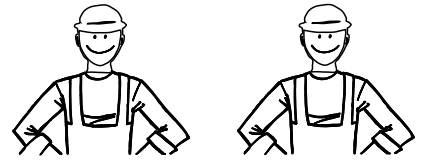
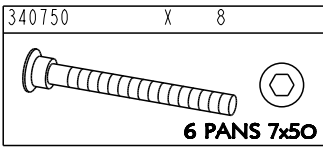
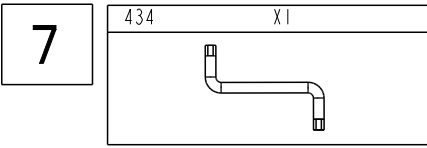

! Face brute  
Raw side  
Brutto seite  
Lado Bruto

Runkzijde  
Lato grezzo  
Lado bruto  
Strona surowa

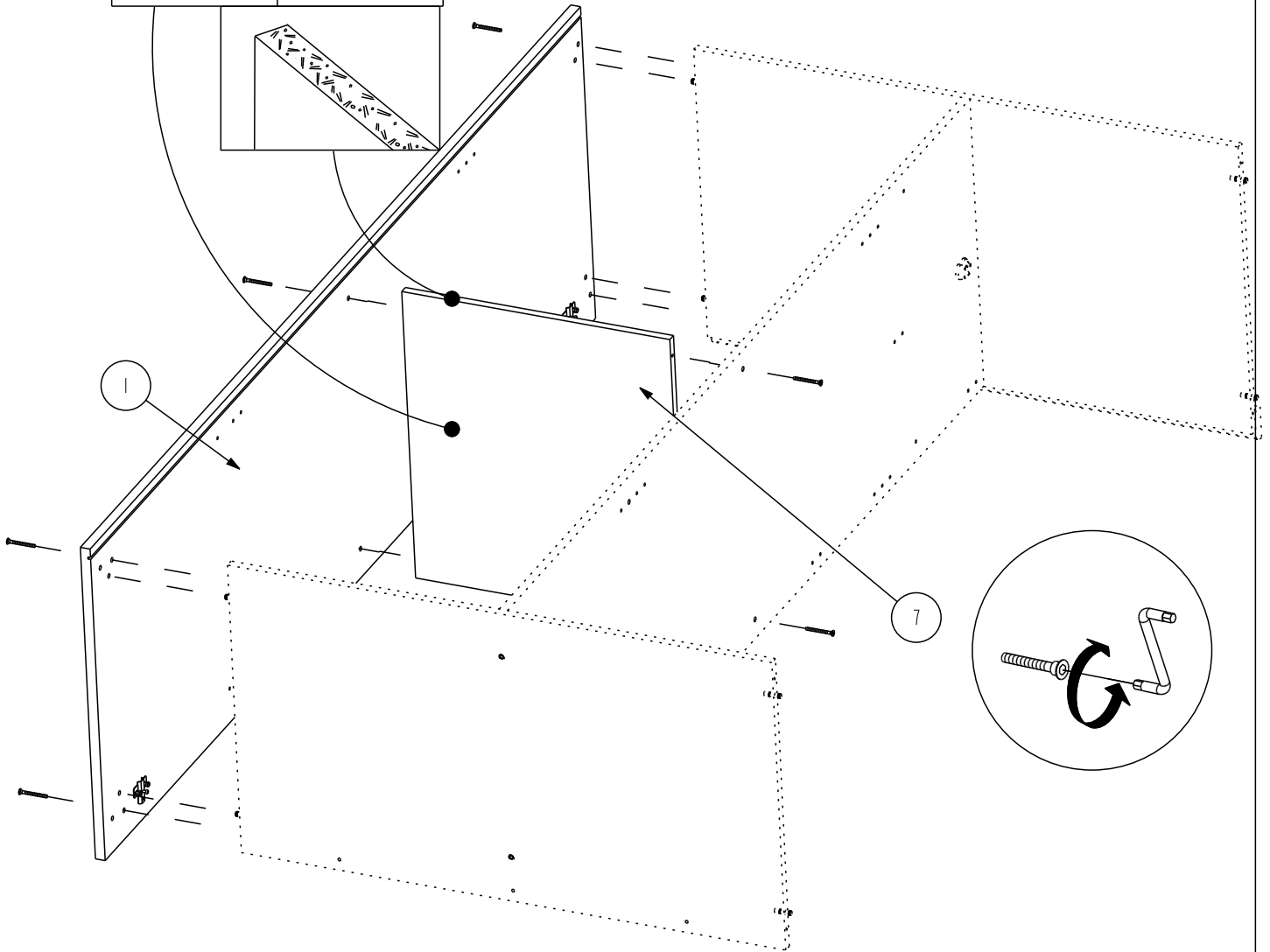

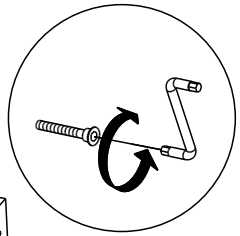
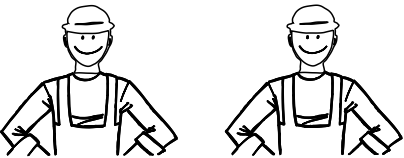

**8**

434 X1

340750 X 8

**6 PANS 7x50**

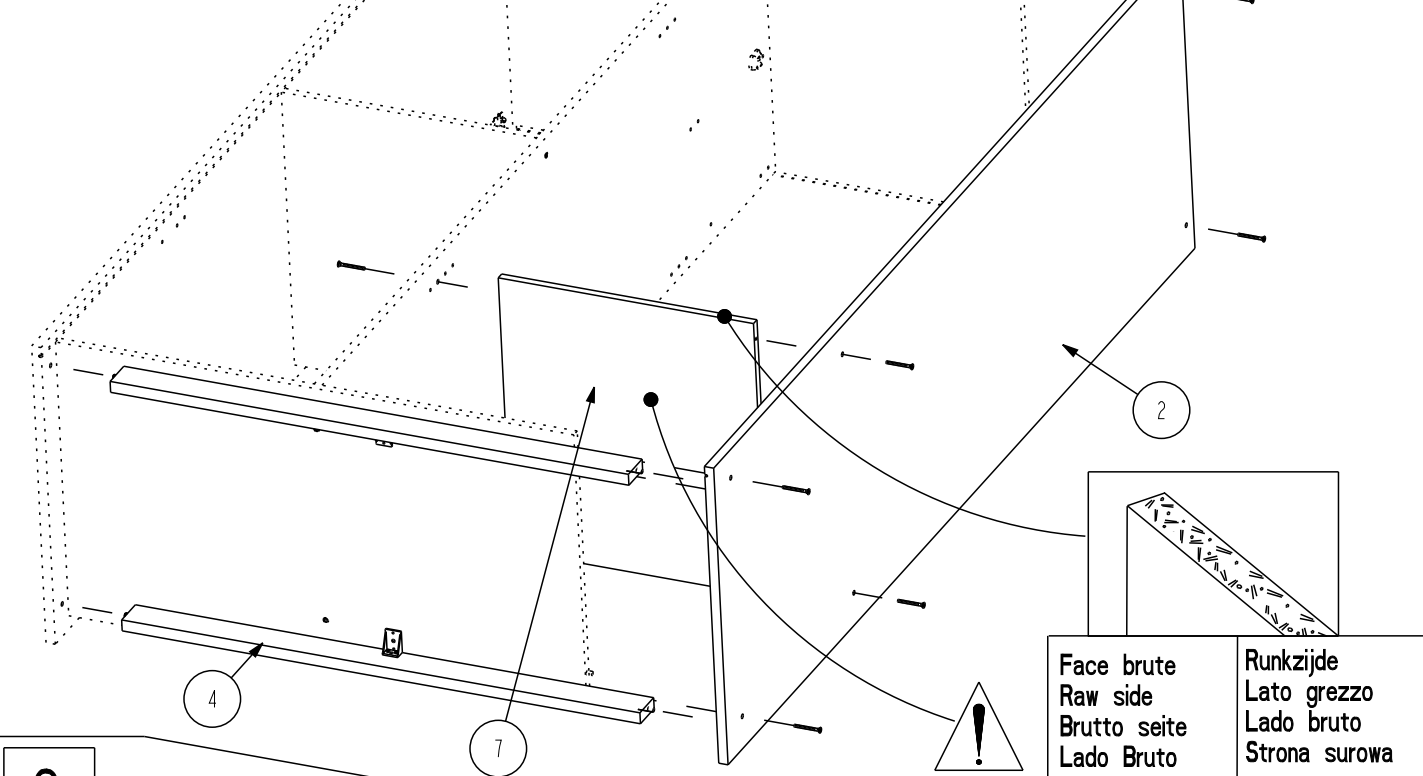

**9**

90°

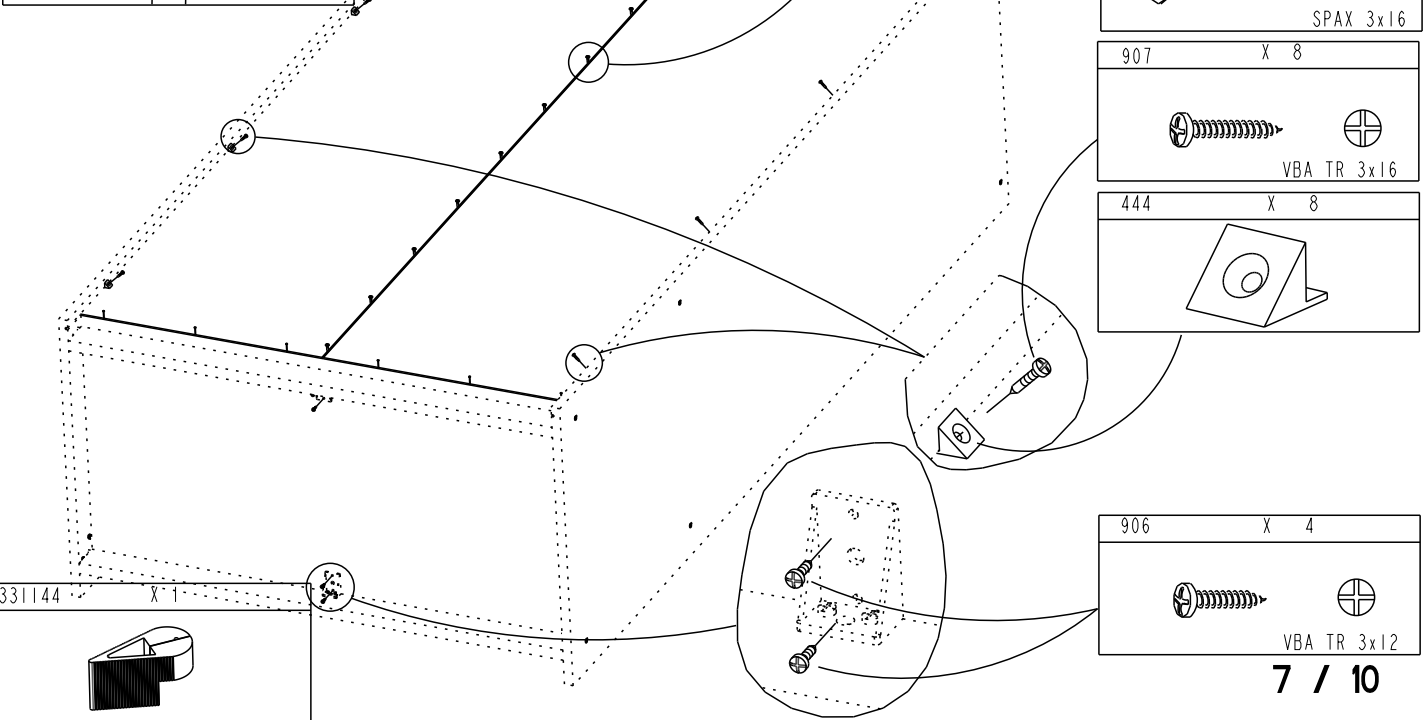

331144 X 1

10

340217

X 2

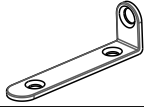

949

X2

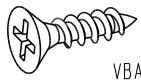

VBA TF 3.5x15



305676 0 09-Apr-10

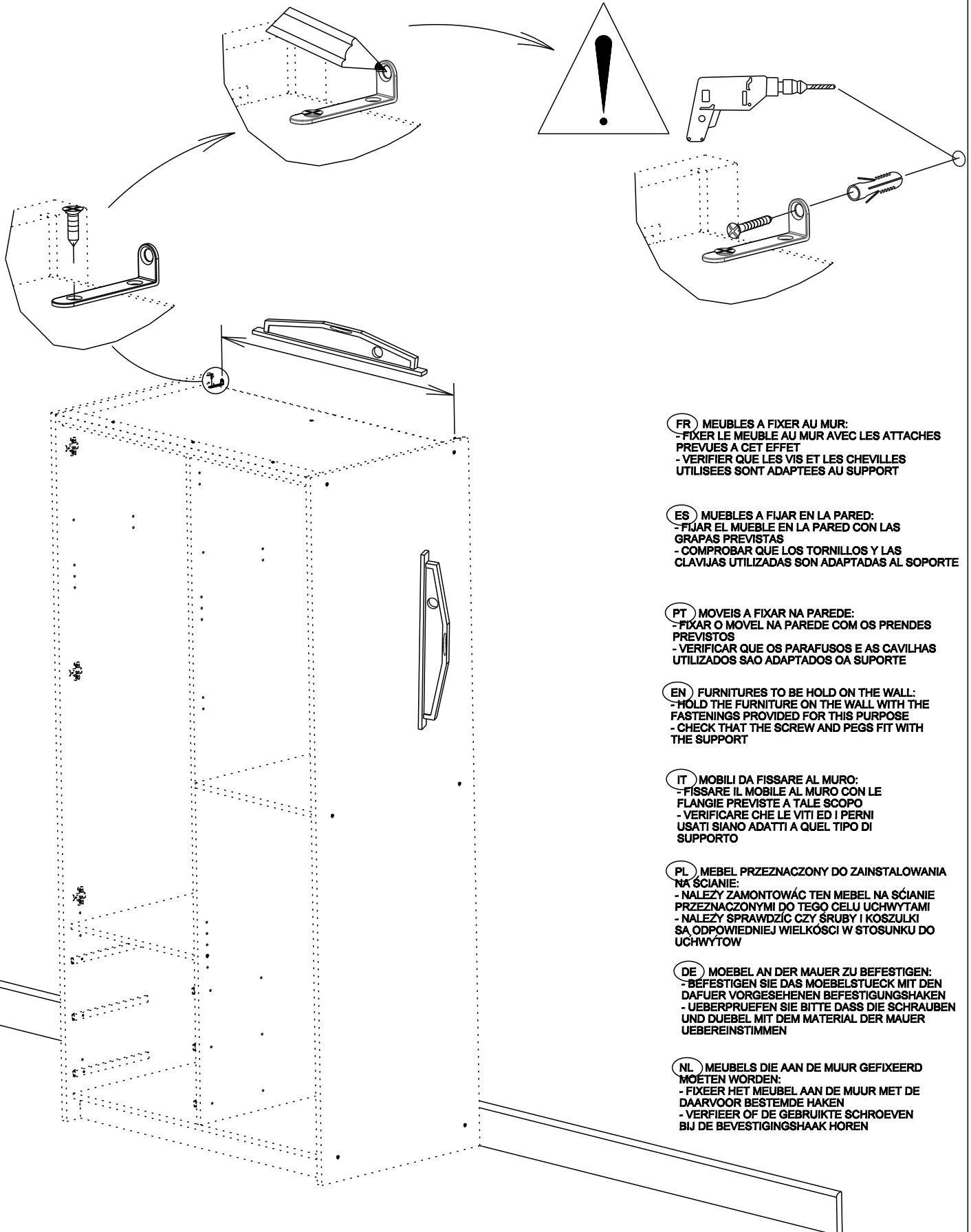

**FR** MEUBLES A FIXER AU MUR:  
 - FIXER LE MEUBLE AU MUR AVEC LES ATTACHES PREVUES A CET EFFET  
 - VERIFIER QUE LES VIS ET LES CHEVILLES UTILISEES SONT ADAPTEES AU SUPPORT

**ES** MUEBLES A FIJAR EN LA PARED:  
 - FIJAR EL MUEBLE EN LA PARED CON LAS GRAPAS PREVISTAS  
 - COMPROBAR QUE LOS TORNILLOS Y LAS CLAVIJAS UTILIZADAS SON ADAPTADAS AL SOPORTE

**PT** MOVEIS A FIXAR NA PAREDE:  
 - FIXAR O MÓVEL NA PAREDE COM OS PRENDES PREVISTOS  
 - VERIFICAR QUE OS PARAFUSOS E AS CAVILHAS UTILIZADOS SAO ADAPTADOS OA SUPORTE

**EN** FURNITURES TO BE HOLD ON THE WALL:  
 - HOLD THE FURNITURE ON THE WALL WITH THE FASTENINGS PROVIDED FOR THIS PURPOSE  
 - CHECK THAT THE SCREW AND PEGS FIT WITH THE SUPPORT



**IT** MOBILI DA FISSARE AL MURO:  
 - FISSARE IL MOBILE AL MURO CON LE FLANGIE PREVISTE A TALE SCOPO  
 - VERIFICARE CHE LE VITI ED I PERNI USATI SIANO ADATTI A QUEL TIPO DI SUPPORTO

**PL** MEBEL PRZEZNACZONY DO ZAINSTALOWANIA NA ŚCIANIE:  
 - NALEŻY ZAMONTOWAĆ TEN MEBEL NA ŚCIANIE PRZEZNACZONYMI DO TEGO CELU UCHWYTAMI  
 - NALEŻY SPRAWDZIĆ CZY ŚRUBY I KOSZULKI SA ODPOWIEDNIEJ WIELKOŚCI W STOSUNKU DO UCHWYTÓW

**DE** MOEBEL AN DER MAUER ZU BEFESTIGEN:  
 - BEFESTIGEN SIE DAS MOEBELSTUECK MIT DEN DAFUER VORGESEHENEN BEFESTIGUNGSHAKEN  
 - UEBERPRUEFEN SIE BITTE DASS DIE SCHRAUBEN UND DUEBEL MIT DEM MATERIAL DER MAUER UEBEREINSTIMMEN

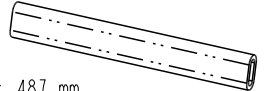

**NL** MEUBELS DIE AAN DE MUUR GEFIXEERD MOETEN WORDEN:  
 - FIXEER HET MEUBEL AAN DE MUUR MET DE DAARVOOR BESTEMDE HAKEN  
 - VERFIEER OF DE GEBRUIKTE SCHROEVEN BIJ DE BEVESTIGINGSHAAK HOREN

11

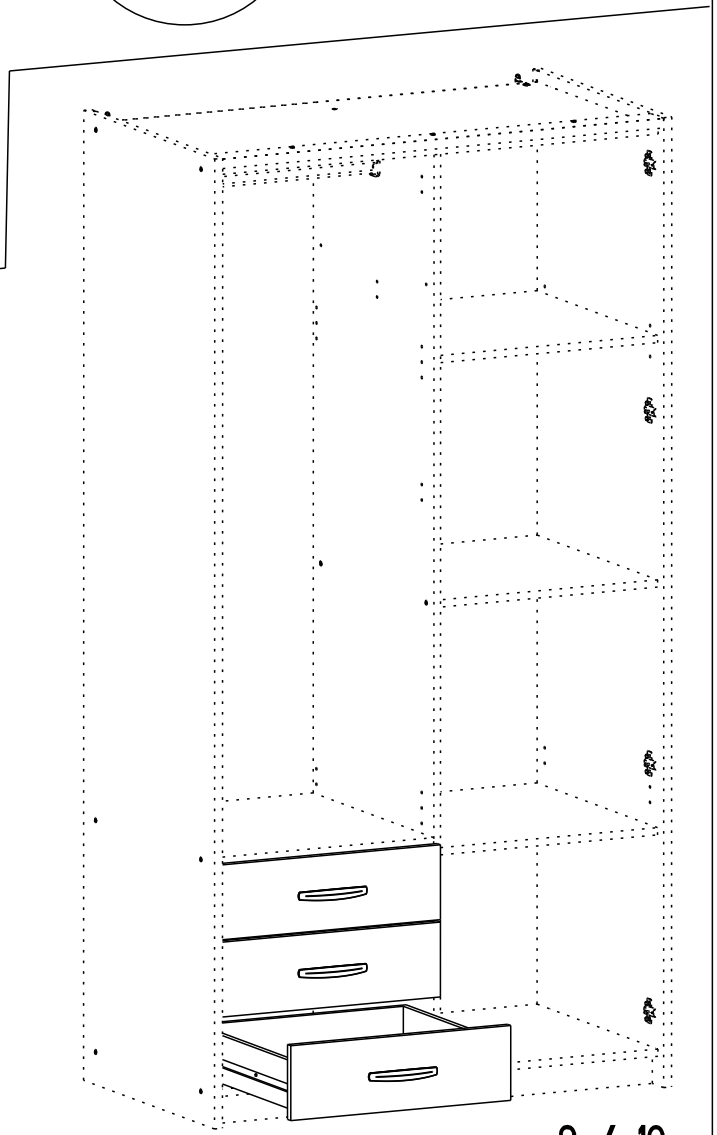
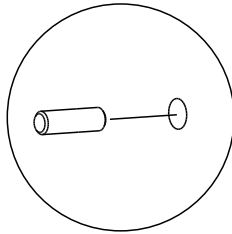
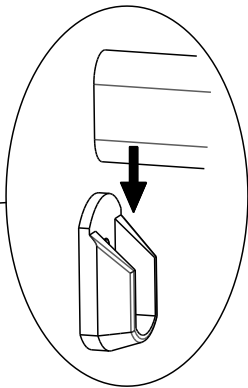
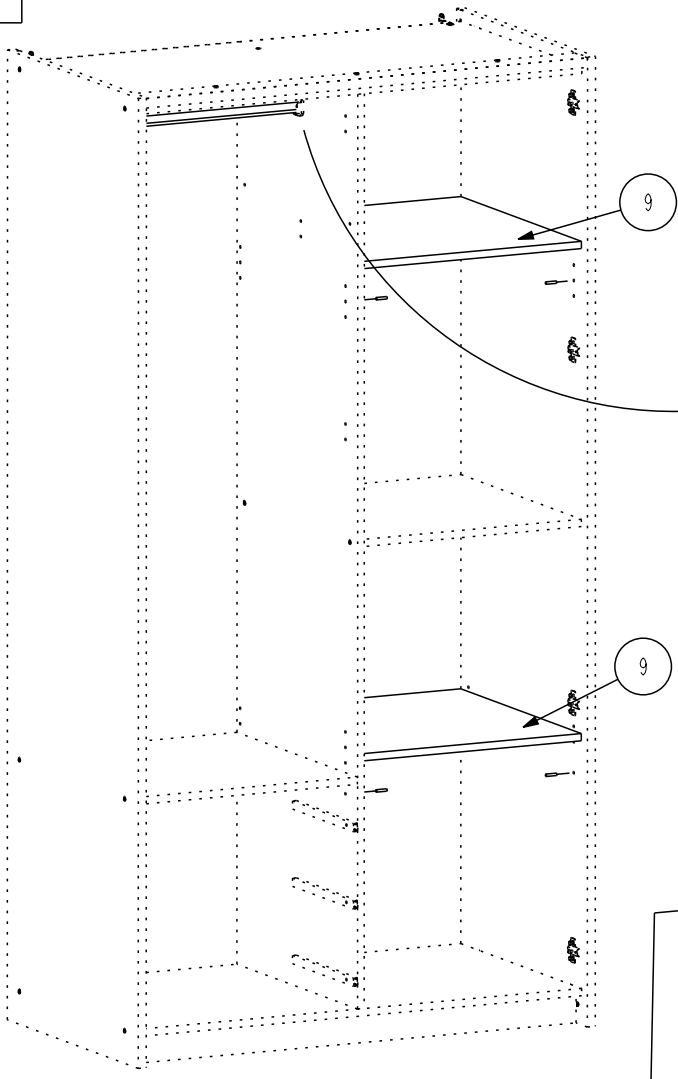
13338	X1
	
L : 487 mm	
351524	X 8
	
Lg: 24mm	



12

983	X 6
	
TR 4x9	

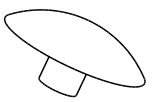
1123	X 12
	

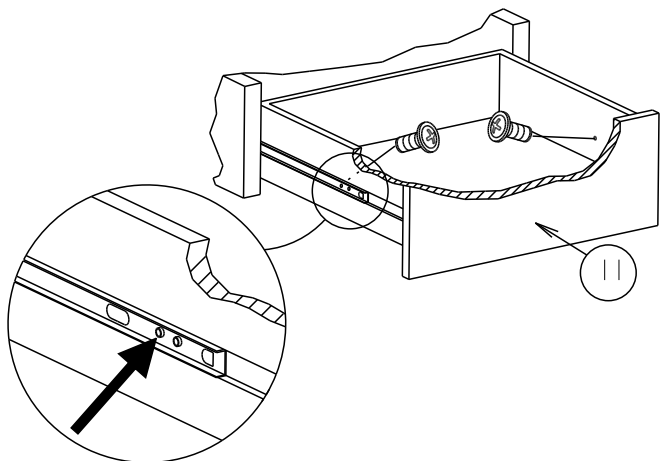

13

333010	X 7	949	X 14
		 VBA TF 3.5x15	

305676 0 09-Apr-10

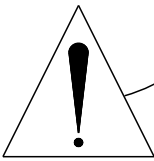
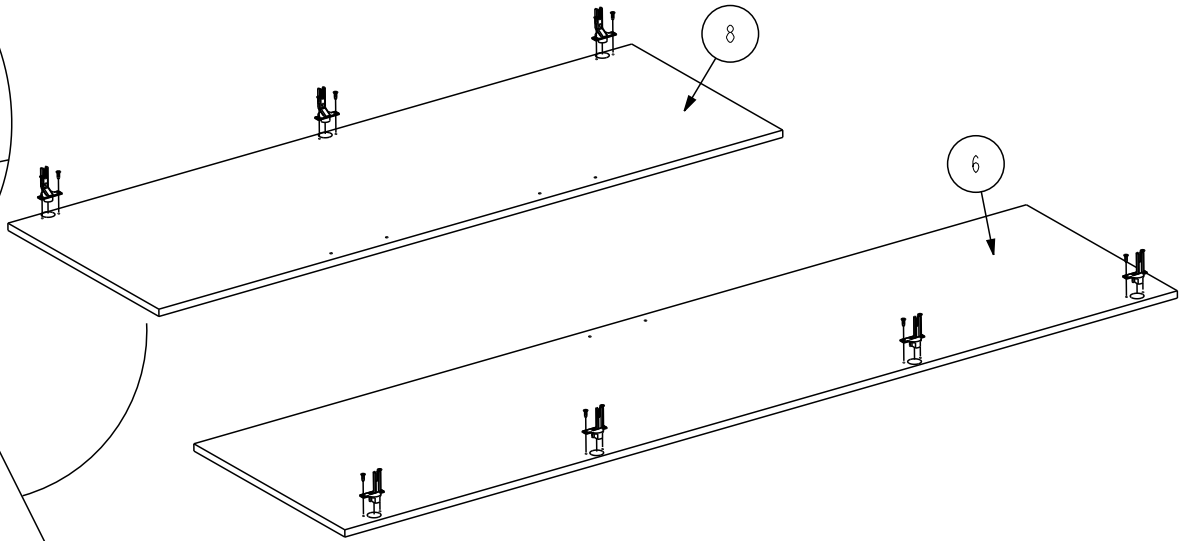
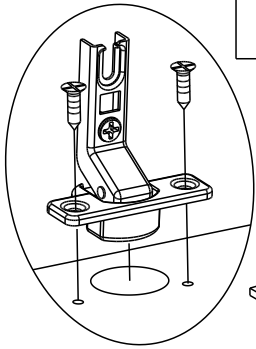

14

332124	X 2	913	X 4
		 VBA TR 4x30	

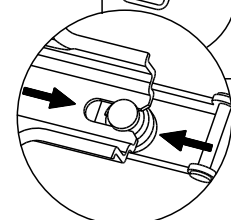
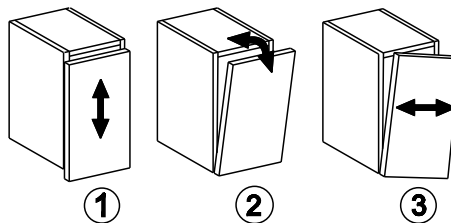
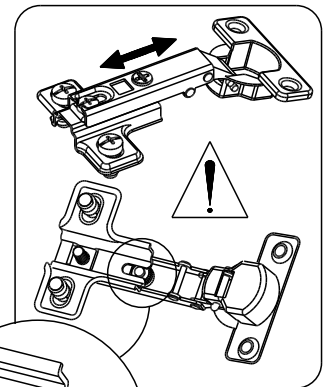
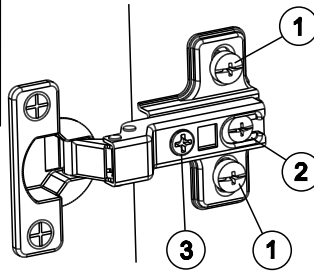
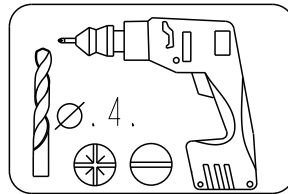
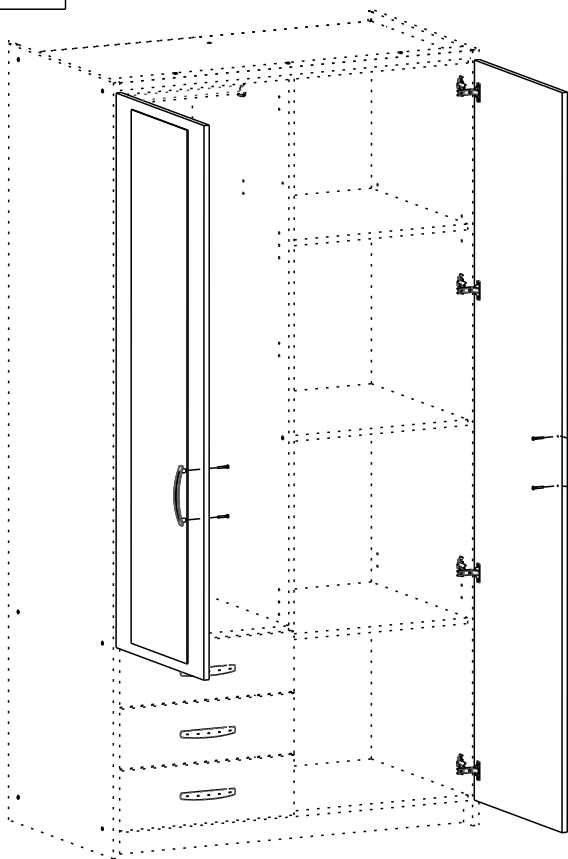

10 / 10