

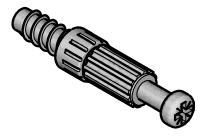

**A** x12



**B** x12



**C** x16

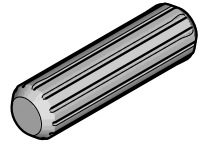

**D** x4

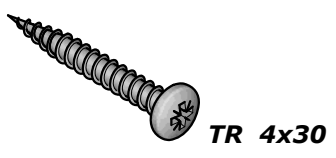

**E** x16



**F** x8

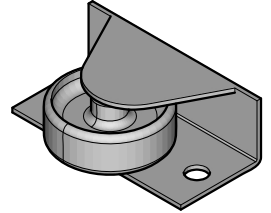

**G** x2

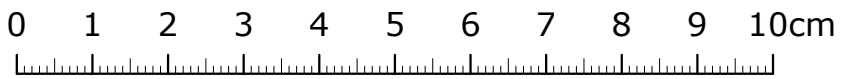
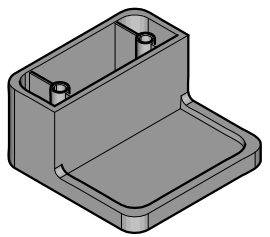

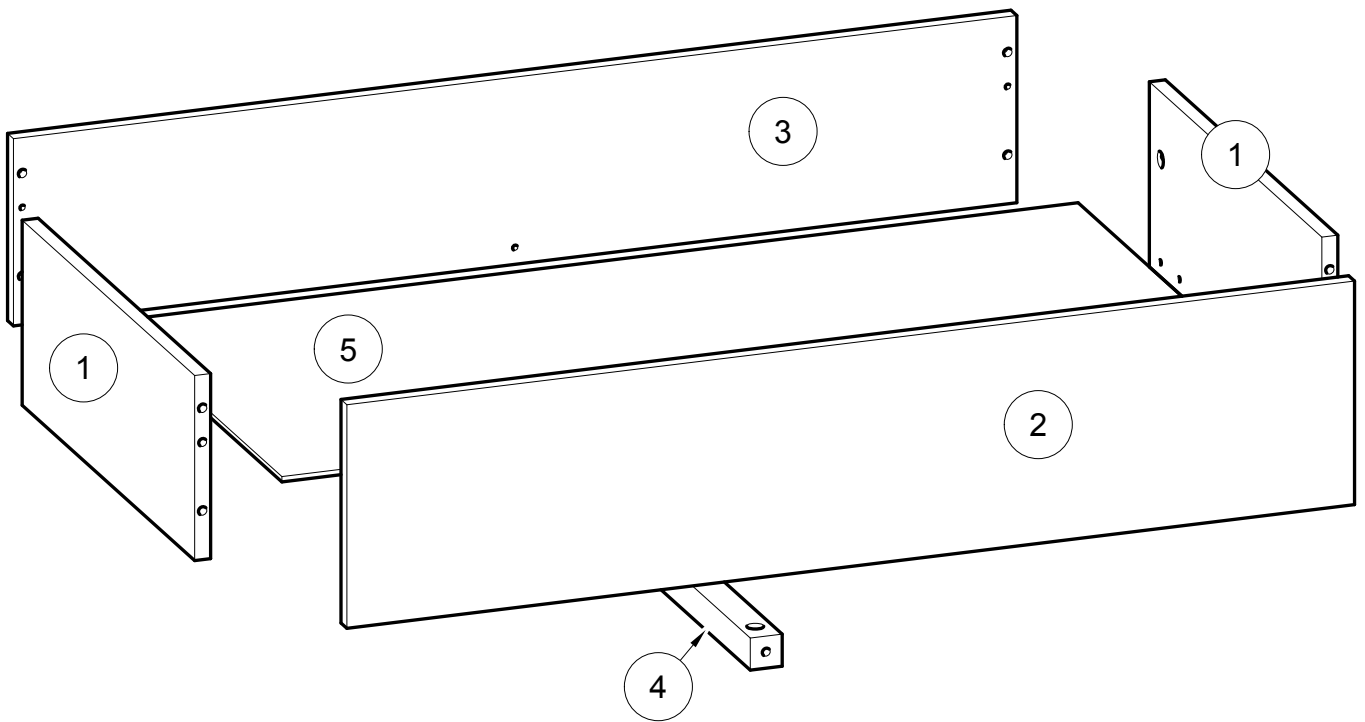

N°	Dim. (mm)	Qty.
1	439 x 173	x4
2	947 x 209	x2
3	943 x 175	x2
4	439 x 30	x2
5	910 x 438	x2

