

Sehr geehrter Kunde, sollte ein Teil fehlen oder beschädigt sein, kreuzen Sie bitte dieses deutlich auf der Montageanleitung an und schicken Sie die Montageanleitung zu.

Cher client, Lorsque vous constatez qu'une pièce est manquante ou abîmée, nous vous prions de bien vouloir la marquer d'une croix sur les instructions d'assemblage et de nous retourner ces instructions d'assemblage.

Dear customer, Should there be any place missing or damaged, kindly mark this place clearly on the attached assembly instructions and return it to us.

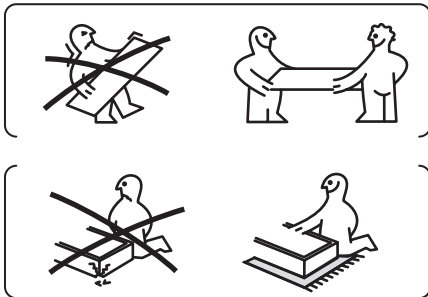
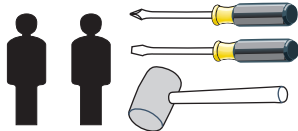

Szanowny Kliencie, gdyby brakowało jakiejś części lub byłaby uszkodzona proszę to oznaczyć krzyżykiem na instrukcji montażowej i przesłać instrukcję razem z reklamacją.







Modellname: **KOMODY**
 Nazwa modelu: **KOMODY**

Modellreihe: **02 -- 34**
 Numer modelu: **02 -- 34**





Type: **KK X**
 Typ: **KK X**



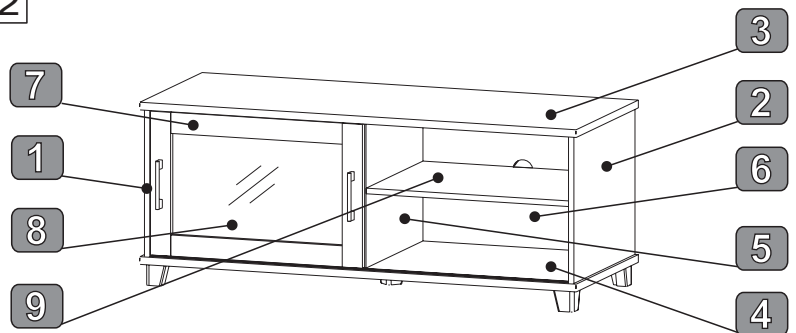

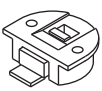
2			
	a X18	b X12	c X12

3		
	c X8	e X15

4		
	g x5	h x15

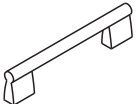

7				
	a x2	b x2	c x4	d x4

9				
	a x2	d x4	j x6	k x6

1

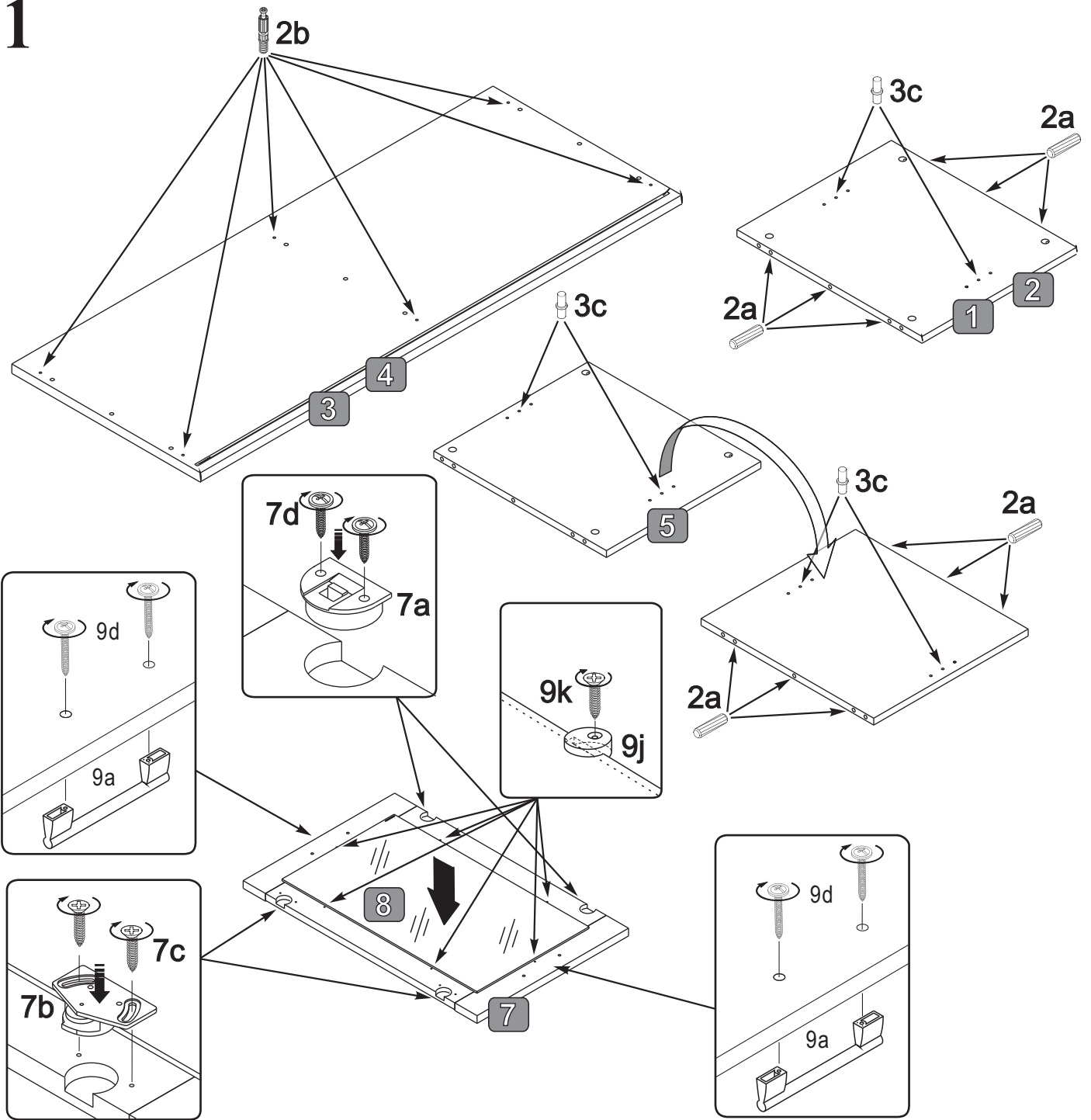

2

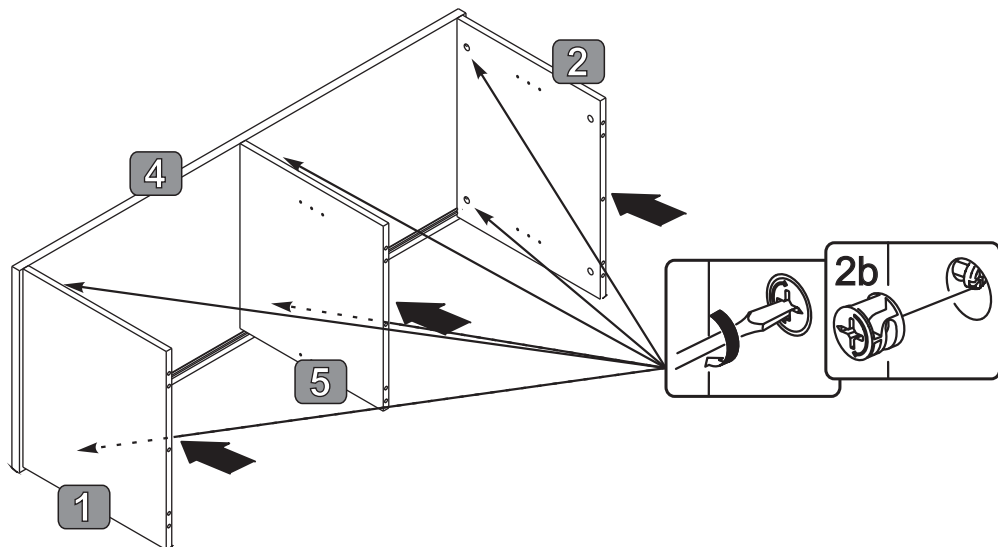

3

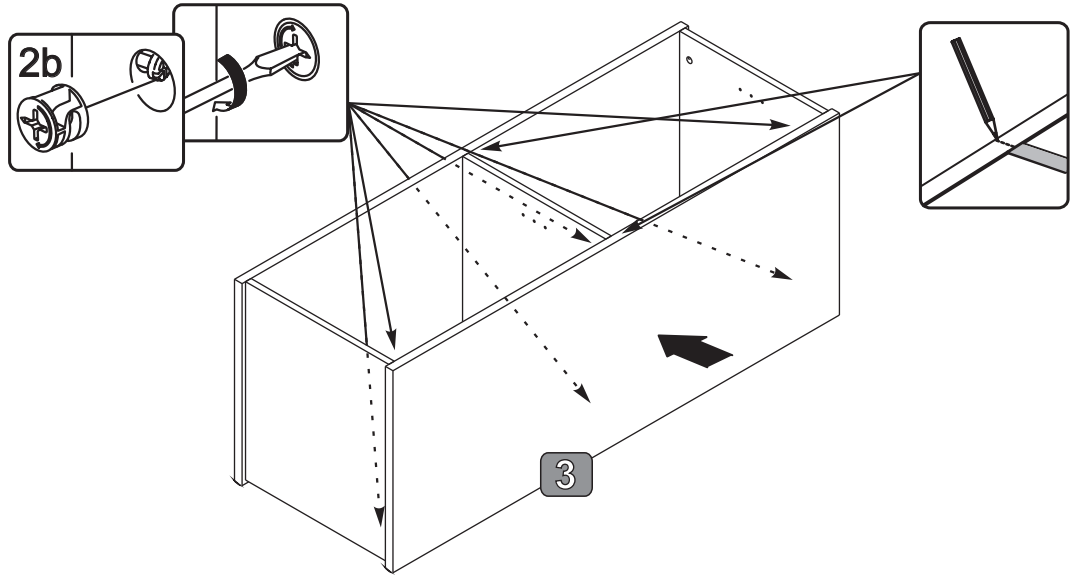

4

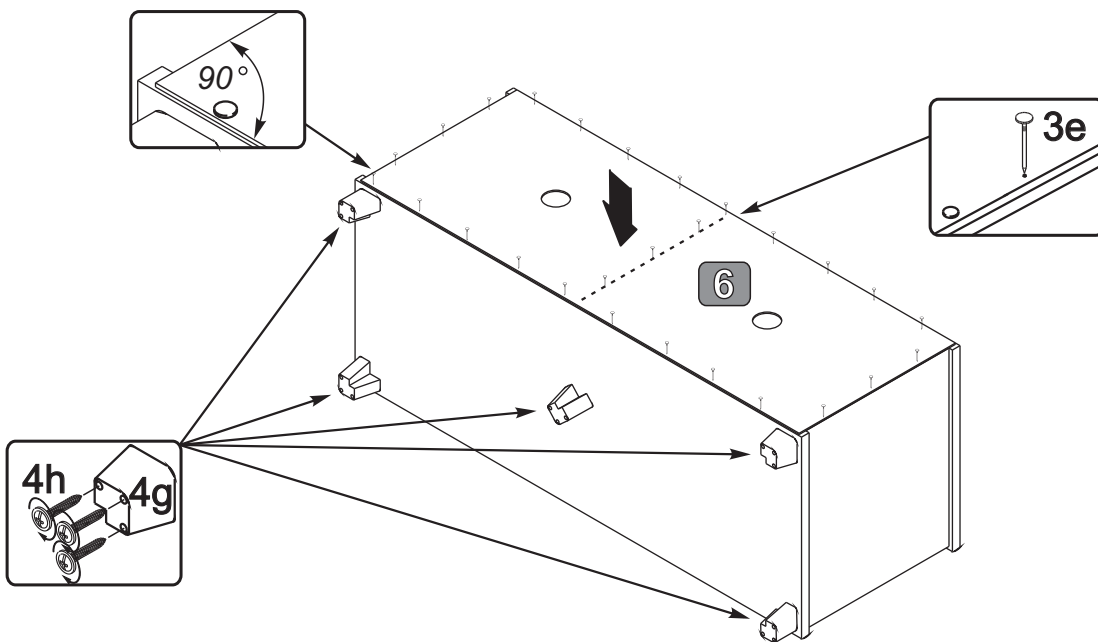

5

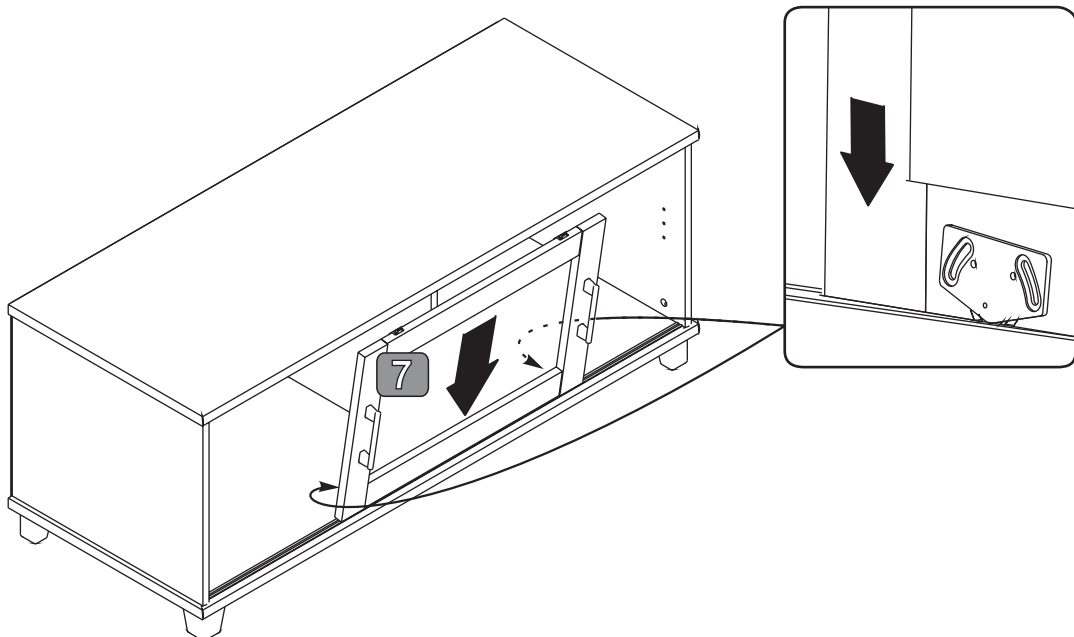

6

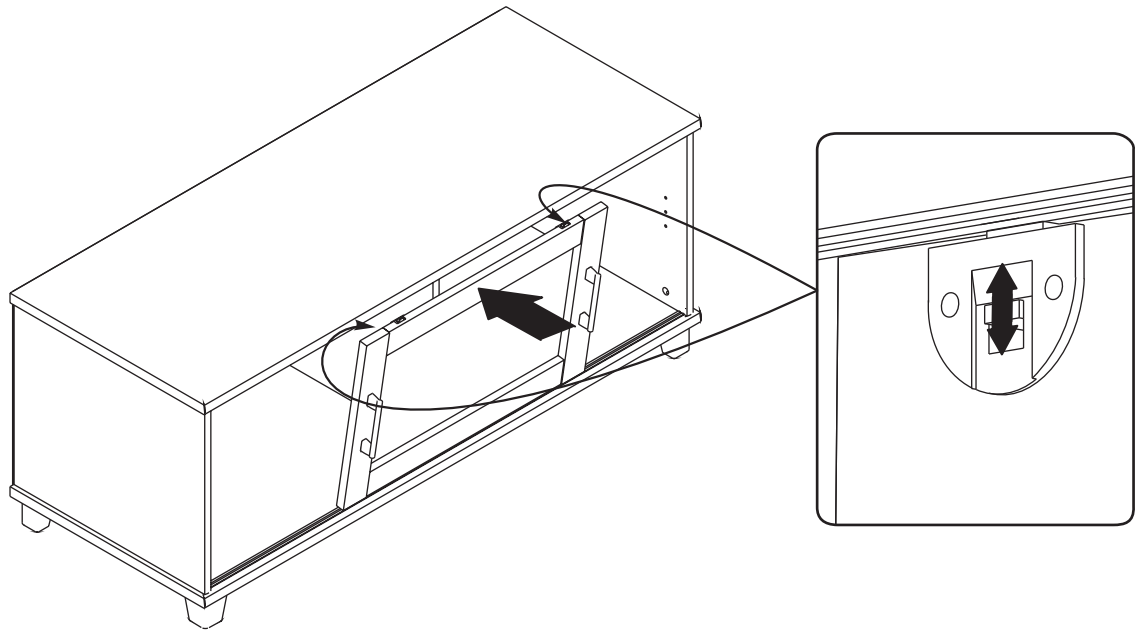

7

