

Sehr geehrter Kunde, sollte ein Teil fehlen oder beschädigt sein, kreuzen Sie bitte dieses deutlich auf der Montageanleitung an und schicken Sie die Montageanleitung zu.

Cher client, Lorsque vous constatez qu'une pièce est manquante ou abîmée, nous vous prions de bien vouloir la marquer d'une croix sur les instructions d'assemblage et de nous retourner ces instructions d'assemblage.

Dear customer, Should there be any place missing or damaged, kindly mark this place clearly on the attached assembly instructions and return it to us.

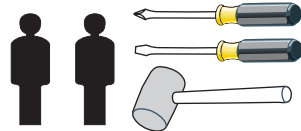









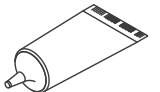

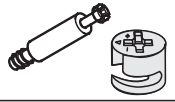





Szanowny Kliencie, gdyby brakowało jakiejś części lub byłaby uszkodzona proszę to oznaczyć krzyżykiem na instrukcji montażowej i przesłać instrukcję razem z reklamacją.

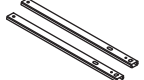

Modellname: **KOMODY**  
Nazwa modelu: **KOMODY**

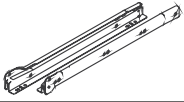
Modellreihe: **02 -- 34**  
Numer modelu: **02 -- 34**

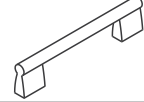
Type: **KK K**  
Typ: **KK K**

<b>1</b>			
	a	X1	
<b>2</b>			
	a	X23	b X14 c X2
<b>3</b>			
	a	X4	b X2 c X4
<b>4</b>			
	c	x4	g x2 h 3,5x35 x6
<b>5</b>			
	a	x2	b x2 c 6,3x13 x8
<b>6.1</b>			
	b	x1	c M4x9 x2 d 3x13 x4
<b>6.2</b>			
	a	x1	b 3,5x13 x10
<b>9</b>			
	a	x2	b 4x30 x4 L 3x16 x8

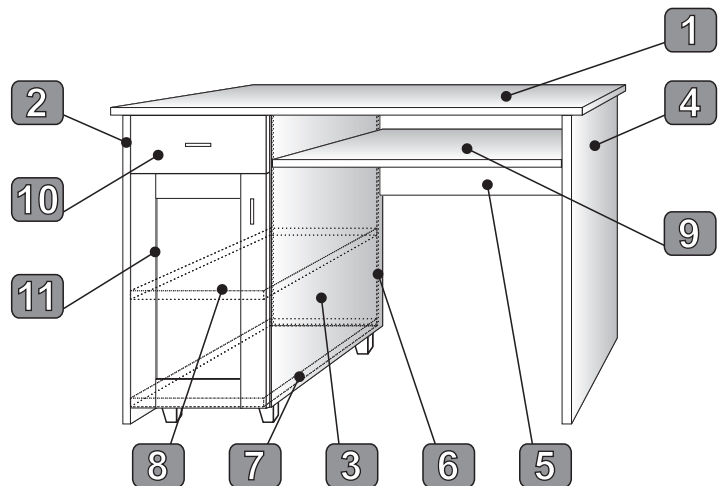
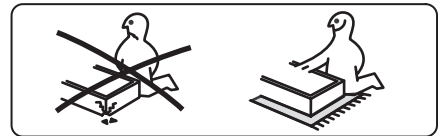

# 1

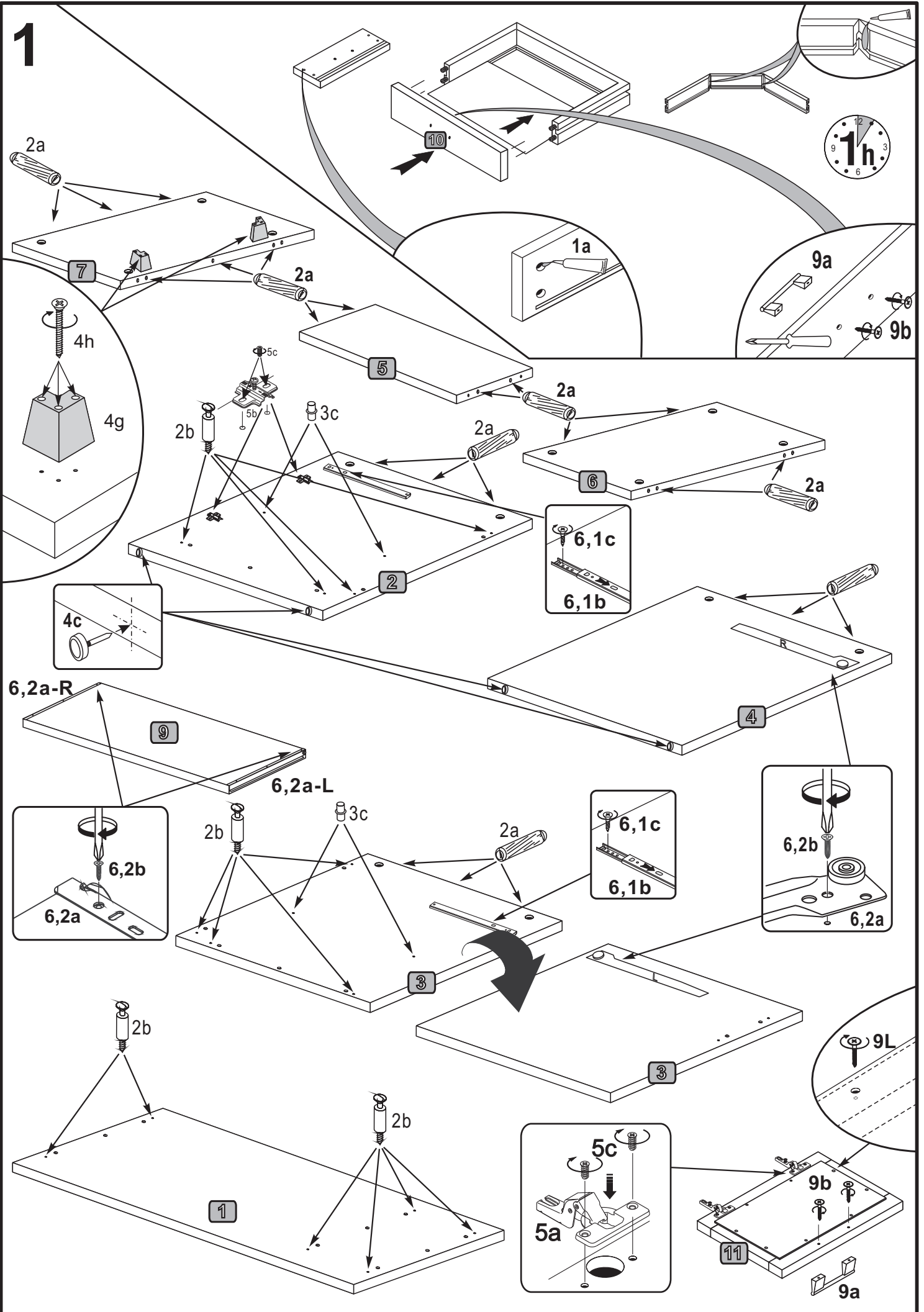

2

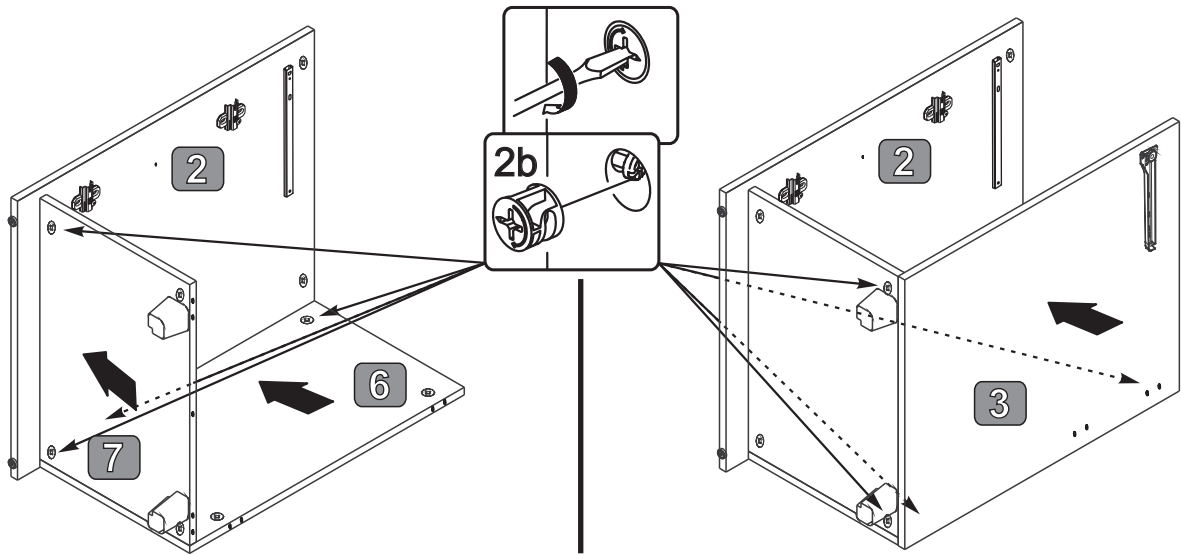

3

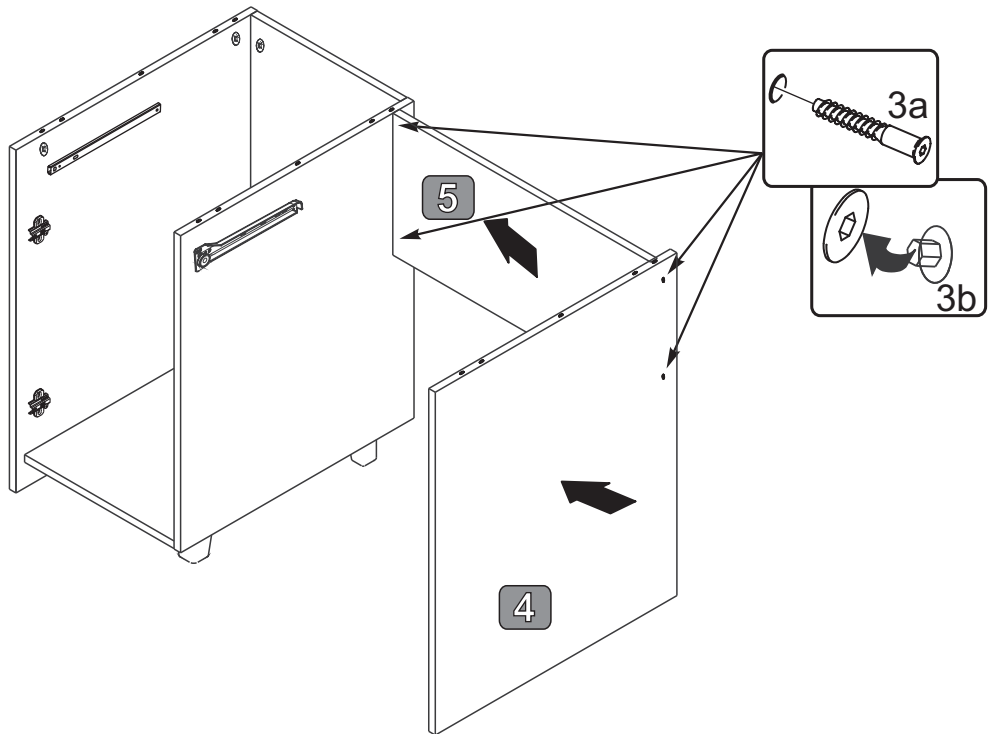

4

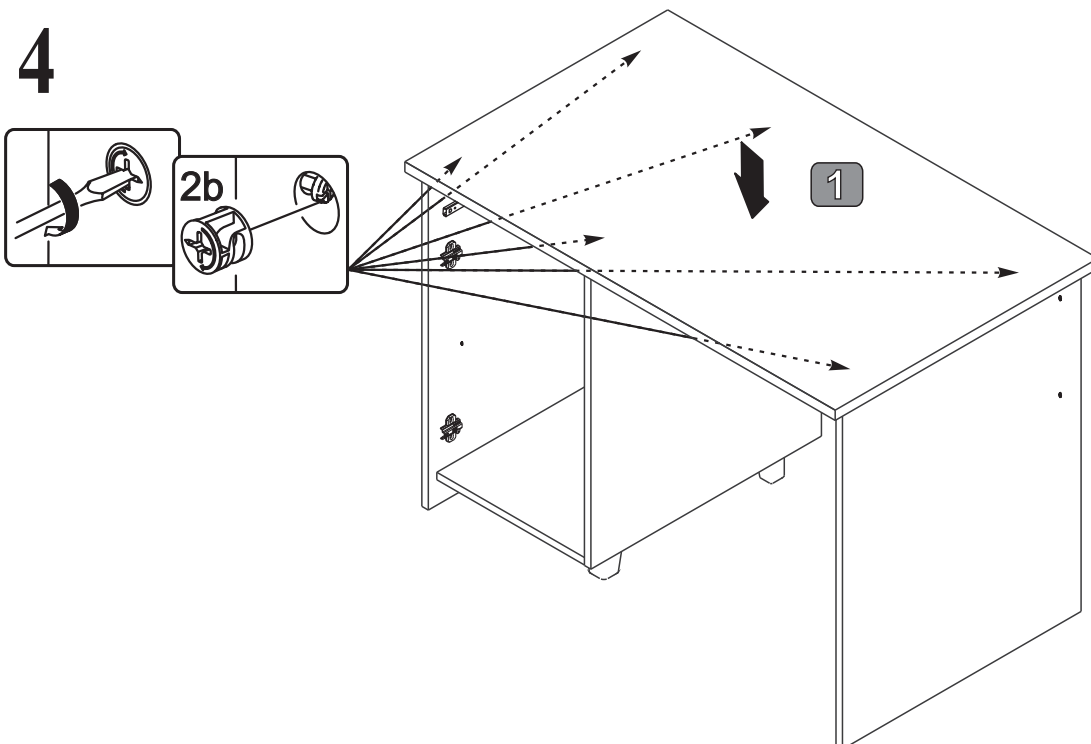

5

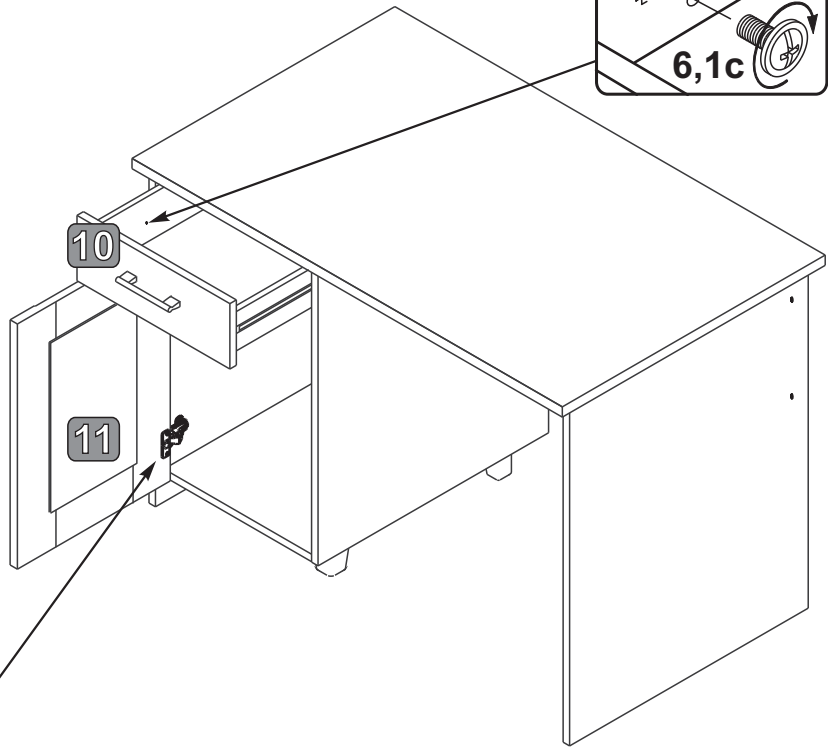
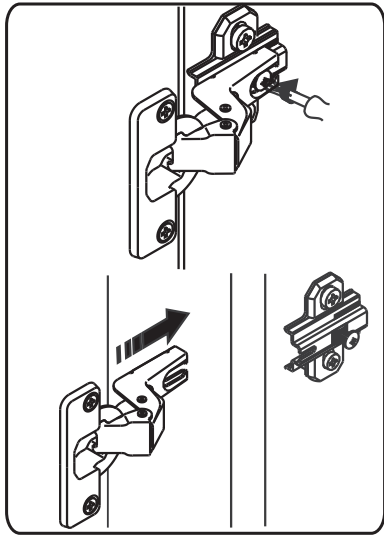
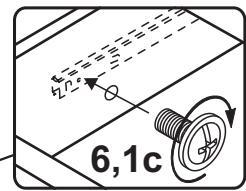

6

