

METALLIST AIAKUUR

KASUTUSJUHEND /
kokkupanekujuhend

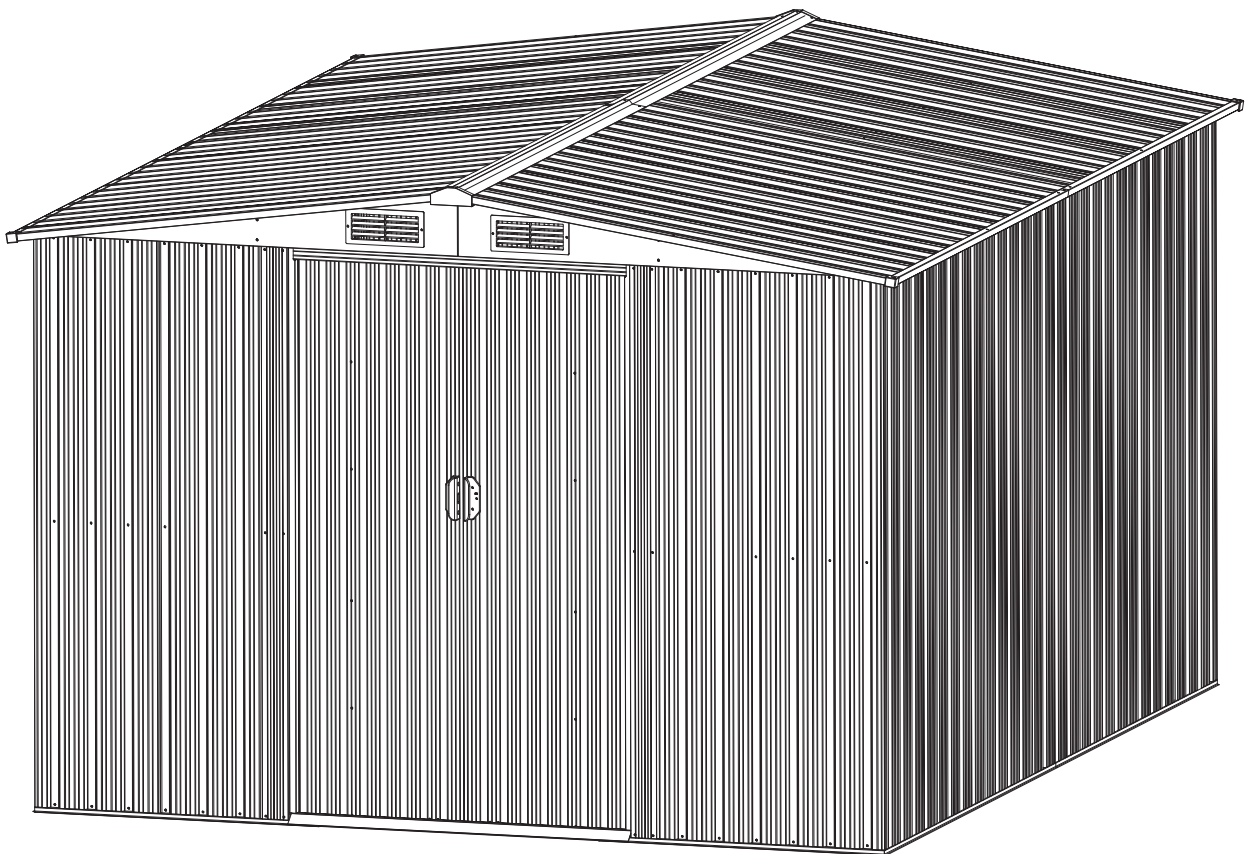

ENNE ALUSTAMIST

Kasutusjuhend

Enne aiakuuri kokkupanekut kontrollige ehitusseaduses sätestatud nõudeid vundamentidele, asukohale jms. Lugege läbi kasutusjuhend ja tehke selle sisu endale selgeks. Olulise teabe järgimine ja praktiliste nõuannete kasutamine hõlbustavad aiakuuri kokkupanekut ja muudavad töö nauditavamaks.

Kokkupaneku juhised

Käesolev kasutusjuhend sisaldab kõiki vajalikke juhiseid teie aiakuuri mudeli kokkupanekuks. Enne kokkupanekut ja kokkupaneku ajal vaadake uuesti üle kõik juhised ning pidage hoolikalt kinni tööde teostamise järjekorrast, et saavutada õiged tulemused.

Detailid ja detailide nimekiri

Kontrollige, et teil oleksid olemas kõik aiakuuri monteerimiseks vajalikud detailid. Võtke detailid pakendist välja ning kontrollige neid vastavalt detailide nimekirjale ja detailide numbritele.

Esimestes sammudes näidatakse, kuidas üksikuid detaile omavahel kokku monteerida.

Tutvuge karpi pakitud kinnitusvahenditega, et teil oleks hõlpsam neid kasutada kokkupaneku ajal. Täiendavad kinnitusvahendid on lisatud teie mugavuse otstarbel.

VAJALIKUD TÖÖRIISTAD

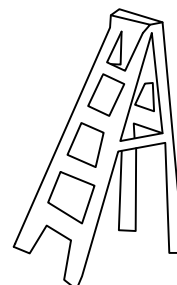
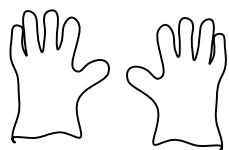

KASUTAGE KINDAID METALLPLAATIDE KOKKUPANEMISEL

KAVANDAGE OMA TEGEVUST



Paigaldamiseks on vaja kahte inimest ja ühte tervet tööpäeva.



















Jälgige ilma:



















Valige aiakuuri paigaldamiseks kuiv ja tuulevaikne ilm. Ärge üritage aiakuuri monteerida tuulise ilmaga. Olge ettevaatlik, kui maapind on märg ja mudane.















Meeskonnatöö:

Võimaluse korral peaks aiakuuri kokku panema kahekesi. üks isik võiks paigaldada detaile või paneele ning teine saaks samal ajal käsitseda kinnitusvahendeid ja tööriistu.

DETAILIDE NIMEKIRI

DETAIL	NUMBER	KOGUS
	1	2
	2	2
	3L	1
	3R	1
	4L	1
	4R	1
	5	1
	6	1
	7	1
	8	1
	9	2
	10L	1
	10R	1
	11	2
	13	4
	14	4
	15	4
	16	2
	17	2

DETAIL	NUMBER	KOGUS
	18	2
	19	2
	20	6
	21L	2
	21R	2
	22	2
	23	2
	24L	1
	24R	1
	25L	1
	25R	1
	P1	2
	P2	4
	P3	16
	P4	2
	P5	6
	P6	6
	P7	1
	19-1	1

DETAIL	NUMBER	KOGUS
	P8	1
	P9	2
	D1	1
	D2	1
	B1	8
	G2	4
	GB	2
	GC	4
	GD	4
	GE	2
	GF	4
	F1	469
	F2	70
	F3	8

KORRASHOID JA HOOLDUS

Pinnakate

- Pinnakatte välimuse pikaajaliseks säilimiseks puhastage ja vahatage välispinda regulaarselt. Kõrvaldage aiakuuril esinevad kriimustused kohe, kui te neid märkate.
- Puhastage kriimustatud piirkonda traatharjaga, seejärel peske seda ja katke viimistlusvärviga vastavalt tootja juhistele.

Katus

- Hoidke katus lehtedest ja lumest puhas, kasutades pika varre ja pehmete harjastega luuda (harja). Katusele kuhjunud lumi võib hoonet kahjustada, muutes sellesse sisenemise ohtlikuks. Lumiste talvedega riikide jaoks on saadaval katuse tugevduskomplektid, mis kaitsevad katust raske lume kuhjumise eest.

Uksed

- Hoidke ukseini alati puhas mustusest ja muust prahist, mis võib takistada uste sujuvat liikumist. Määrige ukseini igal aastal mööbli poleerimisvahendiga või silikoonpihustiga. Hoidke ukсед kinni ja lukus, et vältida tuulest tingitud kahjustusi.

Kinnitusvahendid

- Kasutage kõiki komplekti kuuluvaid tihendeid, et kaitsta metalli ilmastikutingimuste toime ja kruvide põhjustatud kriimustuste eest. Kontrollige regulaarselt aiakuuri kruve, polte, mutreid jt kinnitusvahendeid ning vajaduse korral keerake need tugevamini kinni.

Niiskus

- Plastplaat (aurutõke), mis paigaldatakse hea ventilatsiooniga põranda alla, vähendab kondensaadi tekkimist.

Muud nõuanded:

- Peske kattega paneelidele tindiga märgitud numbrid maha seebi ja veega.
- Kogu hoone ulatuses võib veekindla tihendina kasutada silikoonhermeetikut.
- Ärge hoidke hoones basseini kemikaale.
- Tuleohtlikke ja korrodeerivaid aineid tuleb hoida selleks otstarbeks ettenähtud hermeetilistes mahutites.

Aiakuuri mõõdud

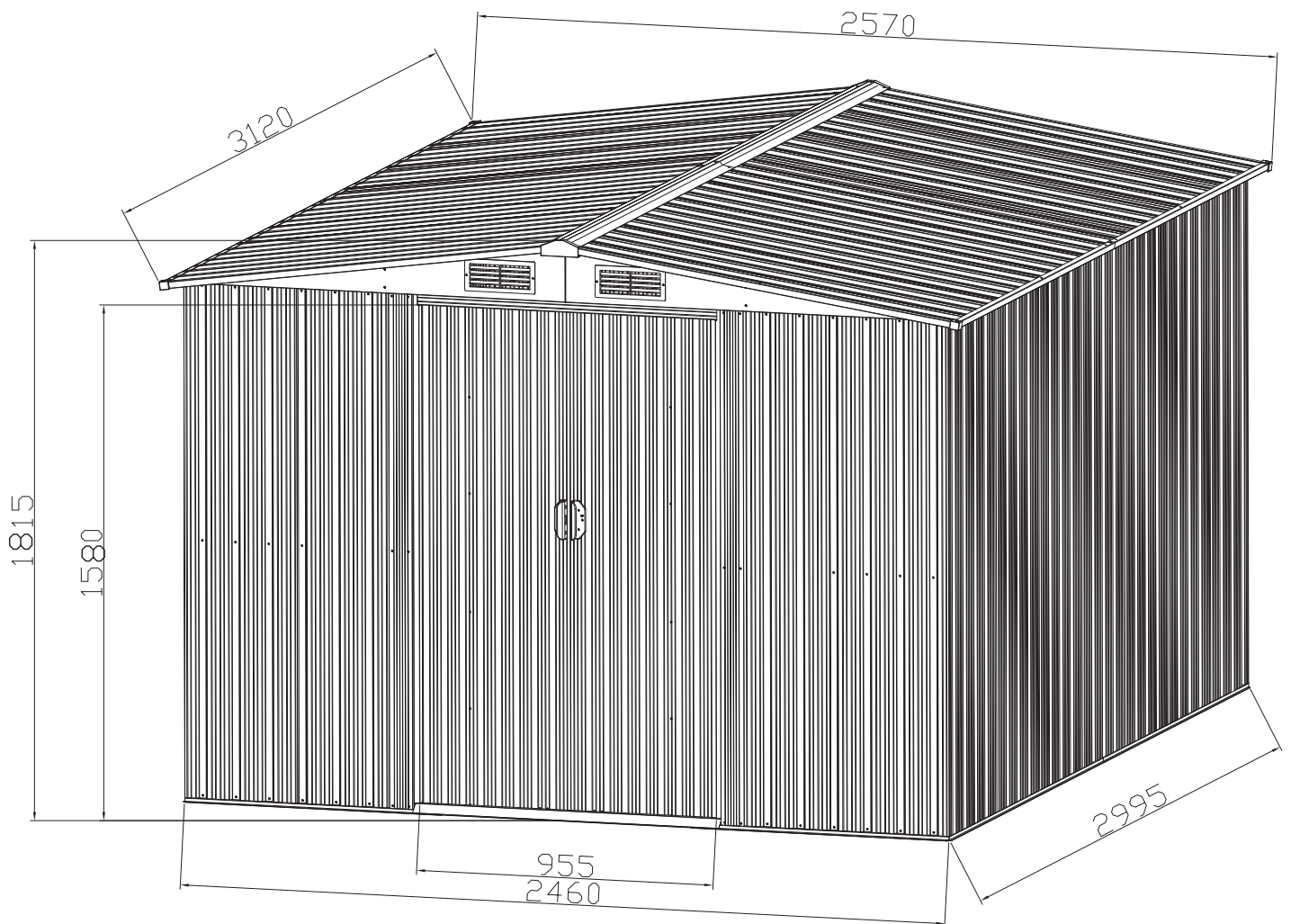

Üldine ülevaade

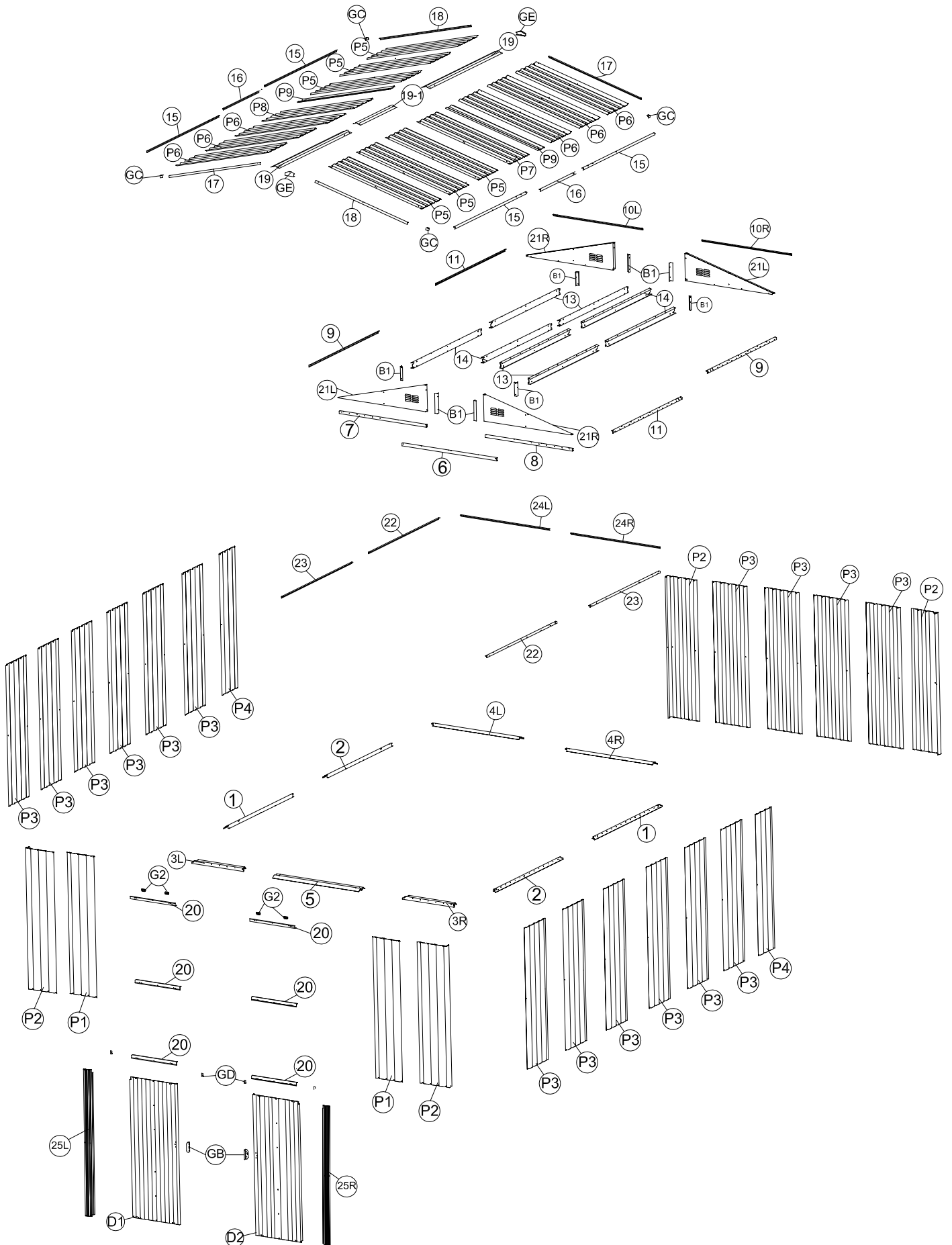

Aluse paigaldamine

Märkus: olge ettevaatlikud teravate ääretega.

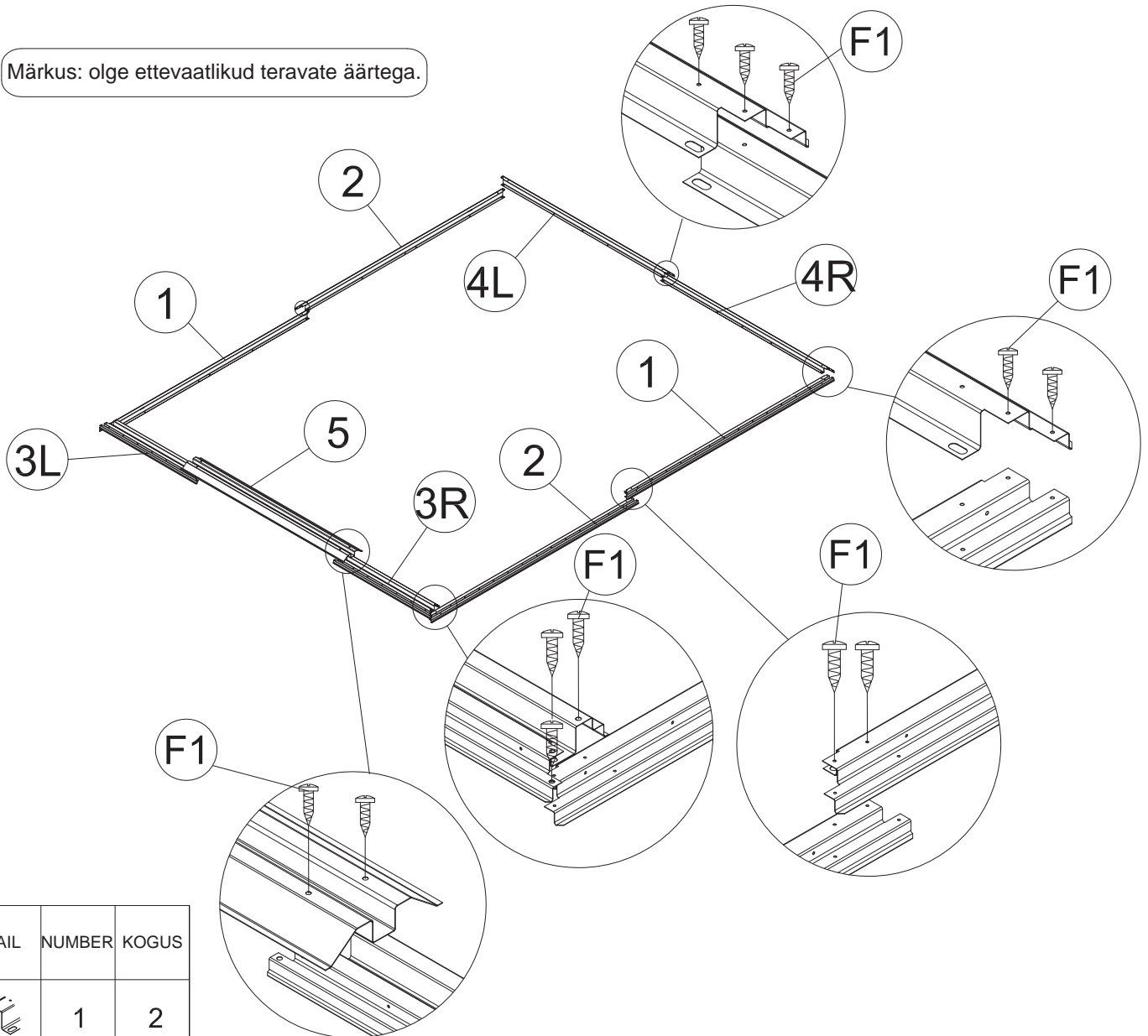

DETAIL	NUMBER	KOGUS
	1	2
	2	2
	3L	1
	3R	1
	4L	1
	4R	1
	5	1
	F1	24

Paigaldamise ajal tuleb kanda kaitsekindaid ja pikkade varrukatega rõivaid, et vältida tsingitud või värvitud terasplaadi teravate servade põhjustatud sisselõikamisi.

Vältige paigaldamise ajal teravate kruvide torkeid ning kaitske käsi selle eest.

Alla 10-aastaste laste ja lemmikloomade viibimine paigalduskohas on keelatud, et vältida mis tahes õnnetusjuhtumeid.

Tuulise ilma korral lõpetage paigaldamine ja pakkige kõik detailid kasti.

Redelil seistes olge ettevaatlik ning kaitske ennast libisemise ja kukkumise eest.



Ärge tõstke värvilist paneeli ühe käega, sest värviline paneel hakkab värisema ja võib hõlpsasti kehasse lõigata.

Hooldus

Ebatasasele maapinnale või lahtisele pinnasekihile paigaldatud garaaž võib jääda kaldu. Palun seadke garaaž kindlasti horisontaalsesse asendisse, et vältida selle deformeerumist.

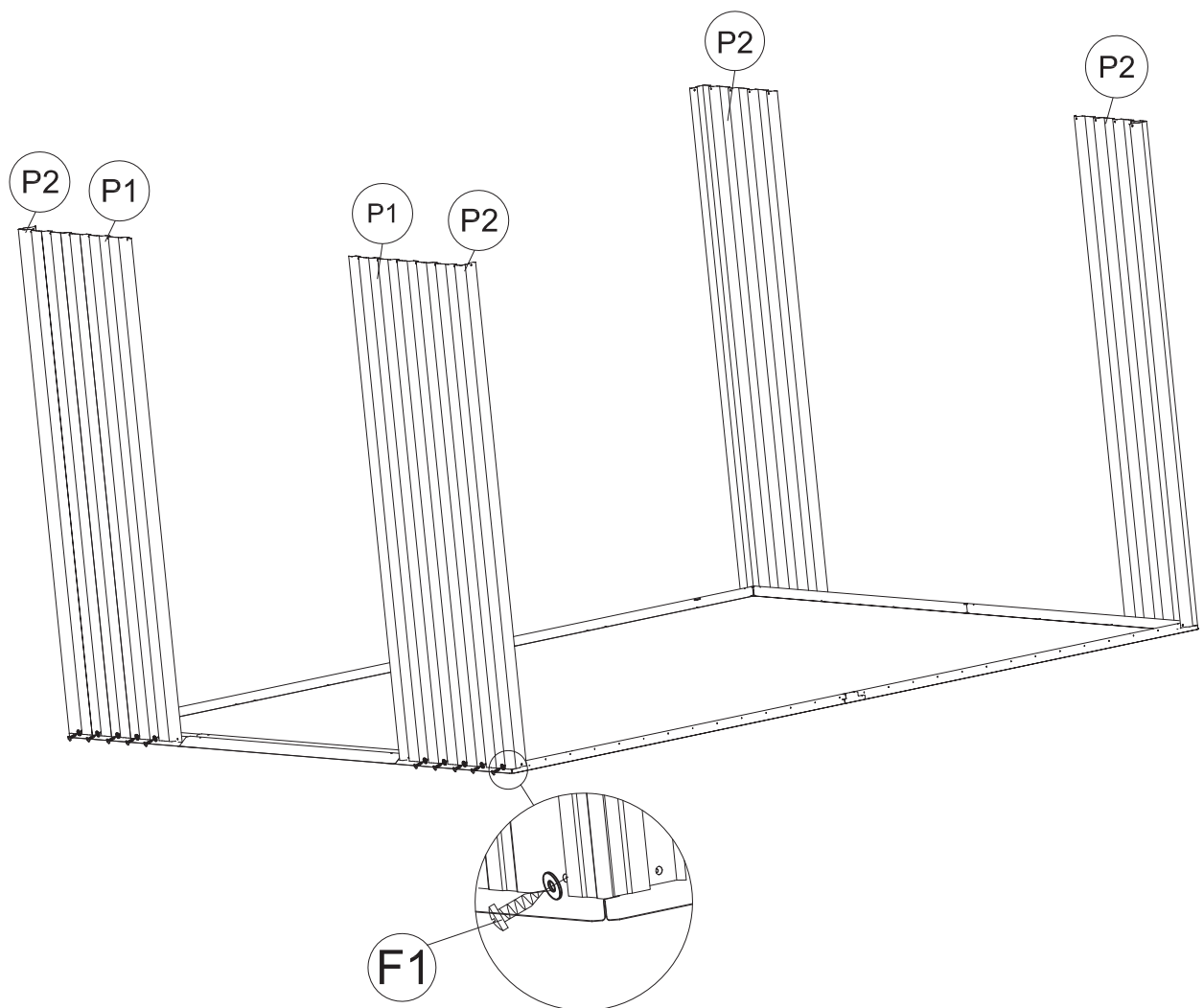
Seina paigaldamine









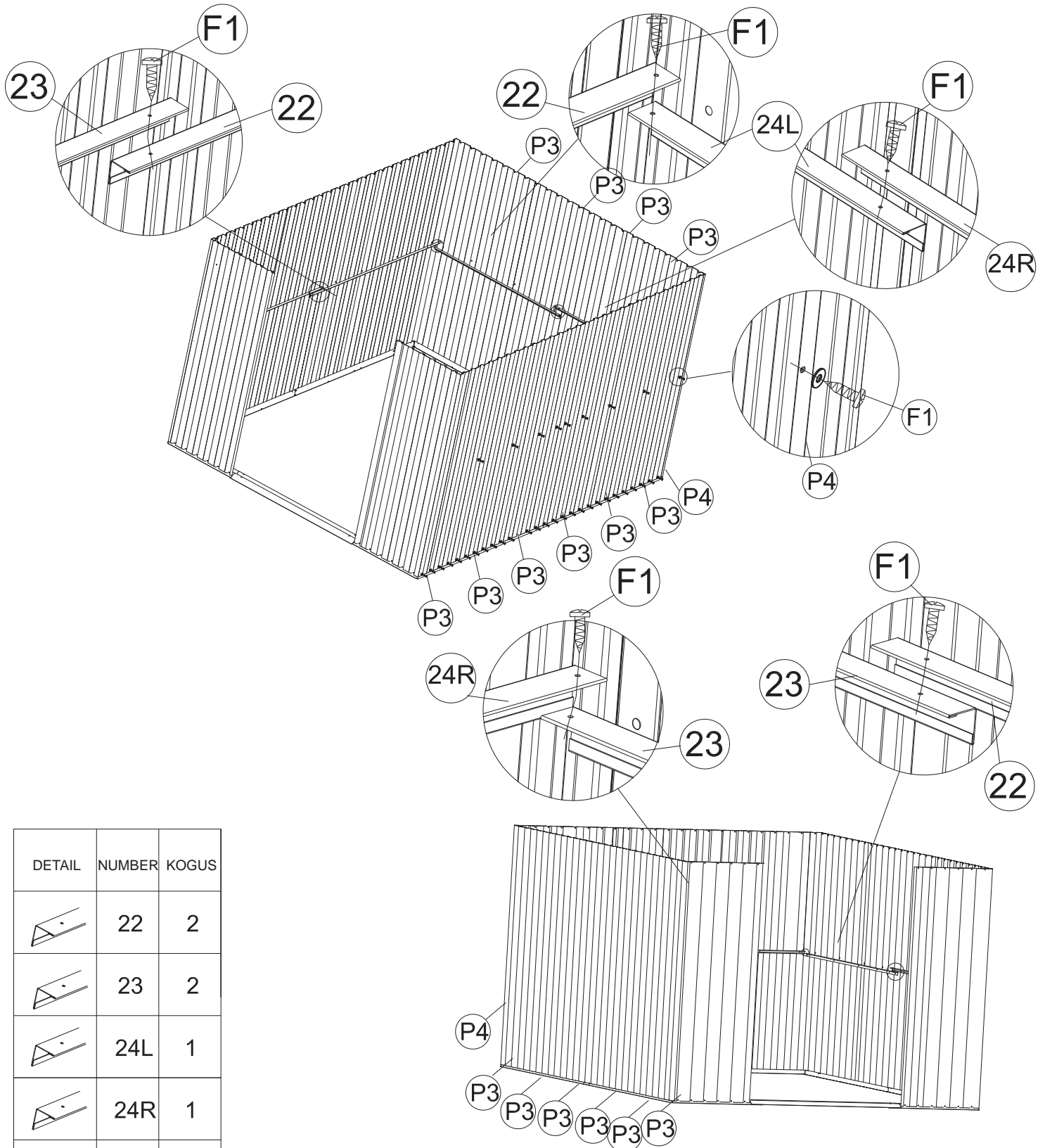

DETAIL	NUMBER	KOGUS
	P1	2
	P2	4
	F1	26

Monteerige seinapaneelid (P1) ja (P2) Kinnitage see kruvidega (F1) aluslattide külge.
Vt allpool antud jooniseid.

Veenduge, et kokkumonteeritud aluslatid moodustavad täisnurkse nelinurga.

Seina paigaldamine



DETAIL	NUMBER	KOGUS
	22	2
	23	2
	24L	1
	24R	1
	P3	16
	P4	2
	F1	150

Monteerige tugevdus latid (22), (23), (24L) ja (24R) ümber paneelide seest poolt, kasutades kruve (F1).

Ukseraami paigaldus

Märkus: Paigaldamisel jälgige, et detaili (G2) eenduv osa jääks sissepoole.

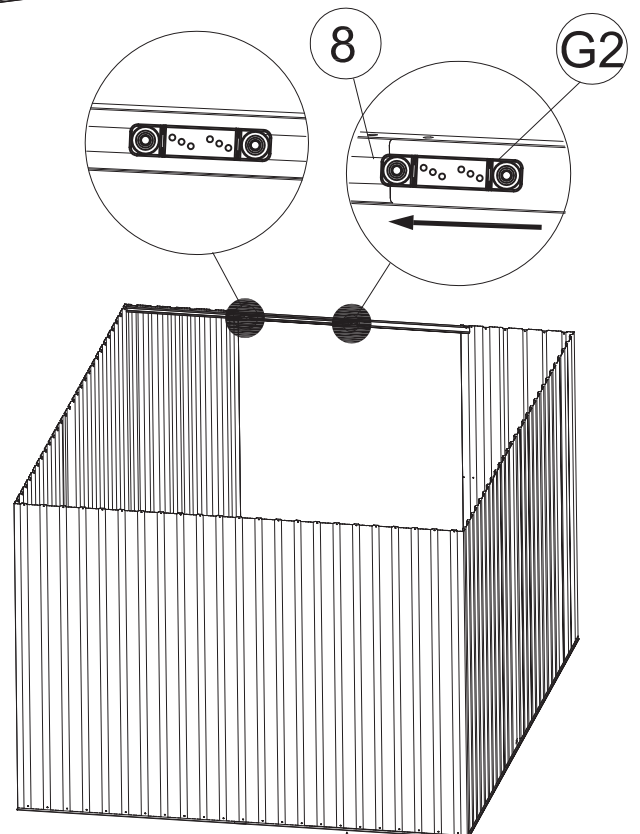
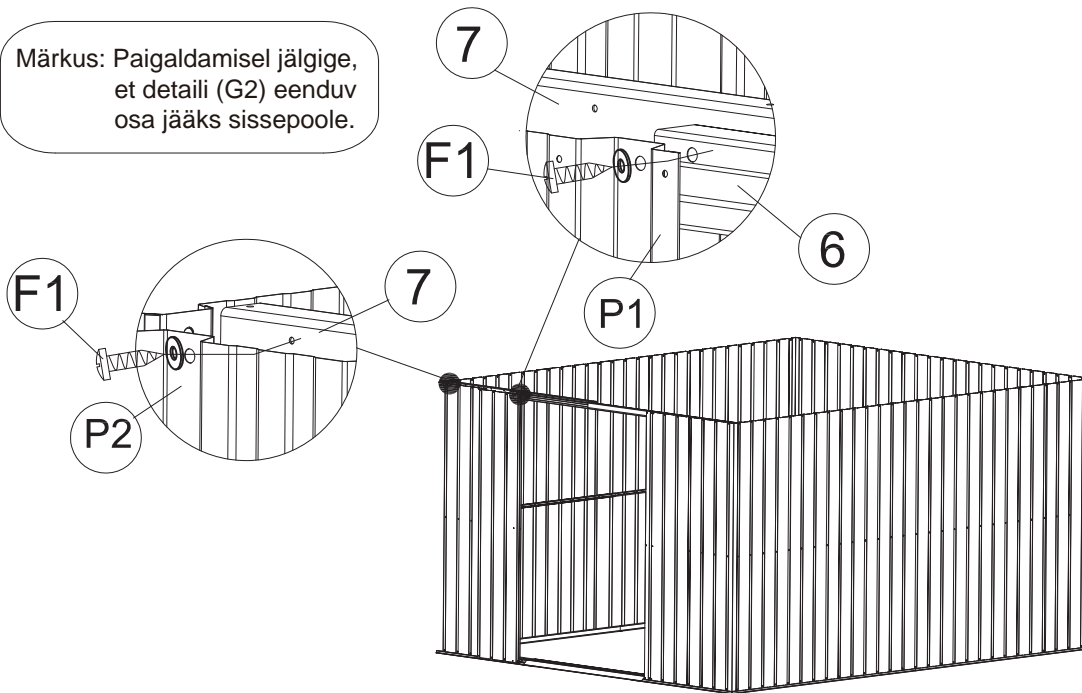

DETAIL	NUMBER	KOGUS
	6	1
	7	1
	8	1
	G2	4
	F1	12

Paigaldage 2 detaili (G2). Lükake detail kanalisse (8). Vt suurendatud joonist.
 Paigaldage ukselatt (6) esiseina paneeli (P1) ja (P2) vahele. Seejärel paigaldage kanalid aukudega. Kasutage kinnitamiseks kruve koos seibidega (F1). Vt allpool antud paigaldusjooniseid.

ülemise raami paigaldus

Note: Make sure the overlapping Position .

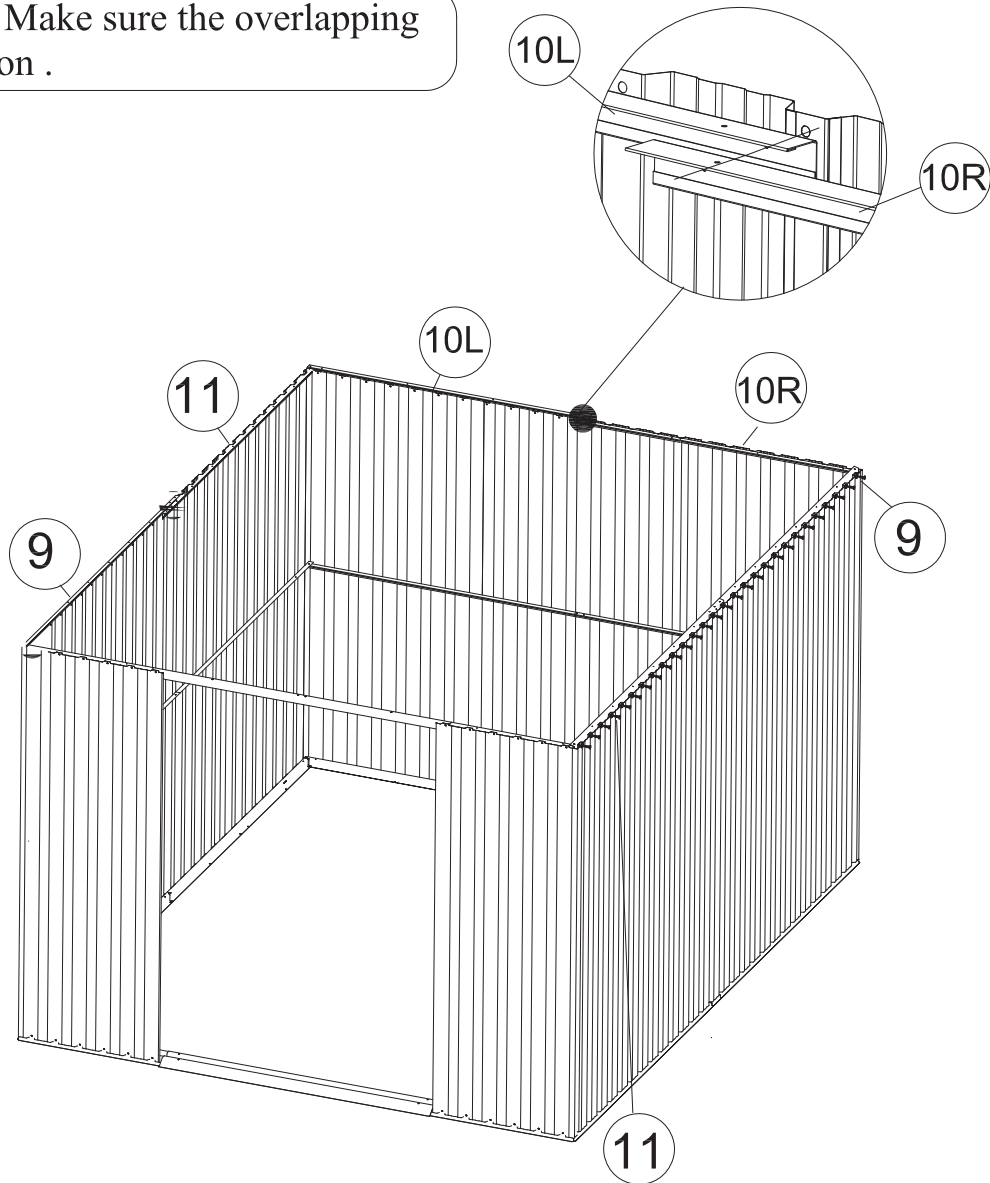

DETAIL	NUMBER	KOGUS
	9	2
	10L	1
	10R	1
	11	2
	F1	87

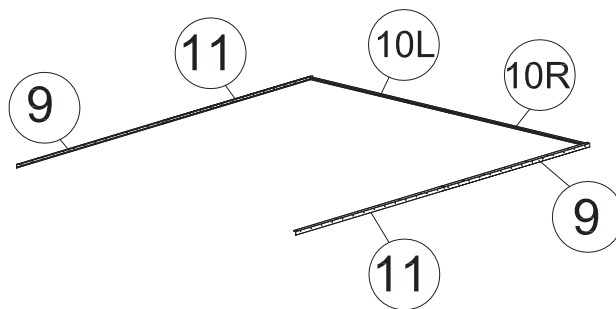

Paigaldage ülemised nurklatid (9), (10L) ja (10R), (11) seinapaneeli peale. Kinnitage kruvidega (F1).

Ukseraami paigaldus

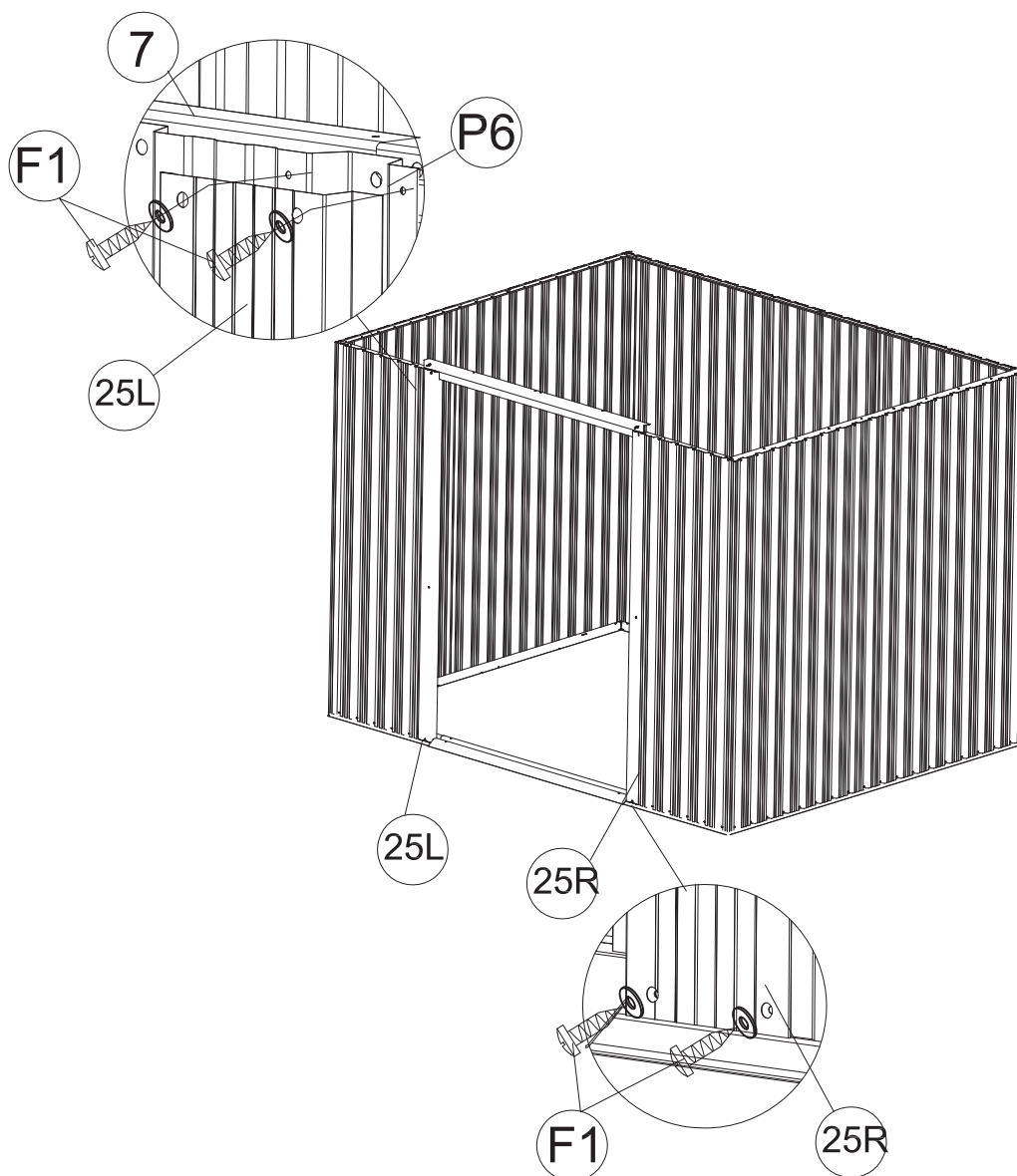





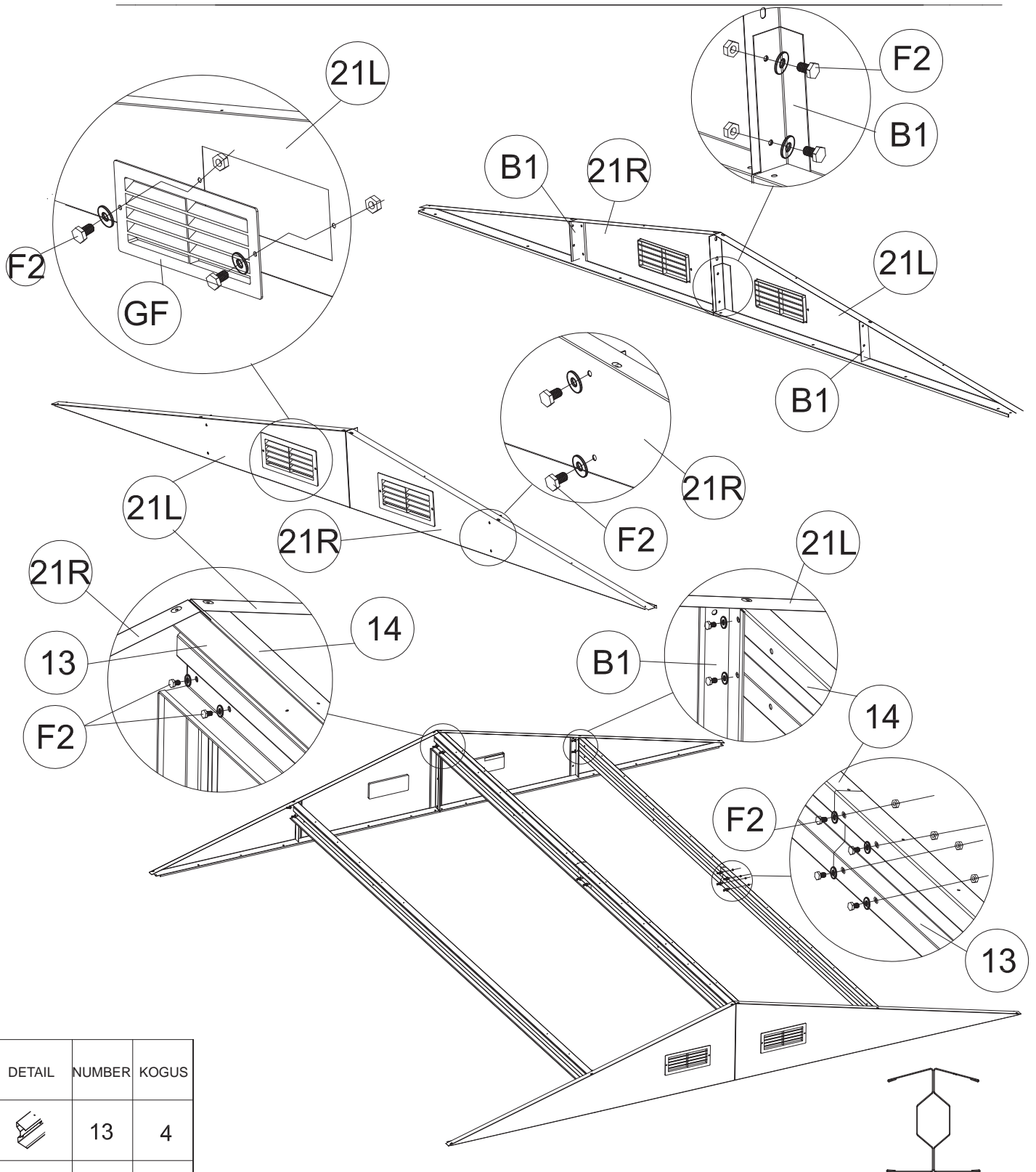

DETAIL	NUMBER	KOGUS
	25L	1
	25R	1
	F1	12

Paigaldage vasakpoolne uksepost (25L) aluslati (3L) peale. Lükake uksepost seinapaneeli sisse. Seejärel kinnitage uksepost (25L) kruvidega (F1). Korrake sama toimingut parempoolse uksepostiga (25R).

Katuse viilu paigaldus



DETAIL	NUMBER	KOGUS			
	13	4			
	14	4			
	B1	8			
	21L	2		GF	4
	21R	2		F2	44

Aiakuuril on kolm katuse latti. keskmine latt vajab 4 kinnitust. Lattide kinnitamiseks on ettenähtud augud, kasutage neid. Kaks küljelatti vajavad ainult 2 kinnitust. Asetage 4 auku üksteise peale ja kinnitage kruvidega.

Katuse struktuuri paigaldus

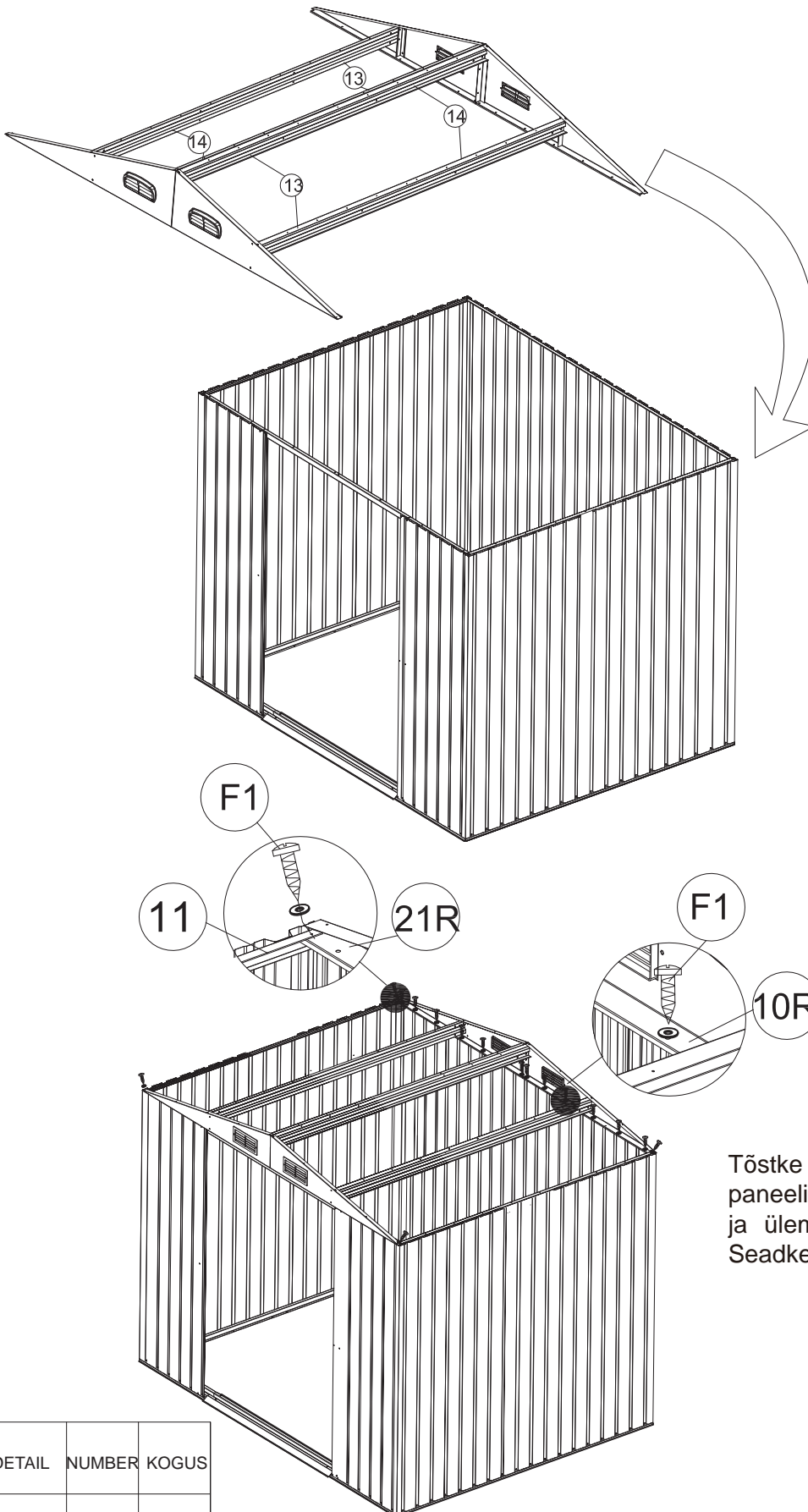

Peale 3 lattide monteerimist, seadke need kohakuti, enne katusele paigaldamist.

Kui kokkupandud on õiges järjekorras, peaksid ülemised avad olema hajutatud samal kaugusel. See on tähtis, sest muidu ei saa katusepaneeli järgmises etapis kinnitada.

Ühendage 2 tugipaneeliga (21L ja 21R) koos tugilattidega (B1), üks mõlemal küljel.

Paigaldage toetuslatid (B1) mõlemad keskkoha poole. Pange need kinni (F2) kruviga





Seejärel ühendage lõpetatud talad lattidele. Keskmise latt fikseeritakse (B1), kasutades F2 kruve. Külglatid kinnitatakse (B1).

Tõstke katuseraam küljepaneelide peale. 4 paneeli (7 and 8) istuvad siini (7 and 8) peale ja ülemiste lattide (10L and 10R) peale. Seadke augud kohakuti (F1) kruvidega

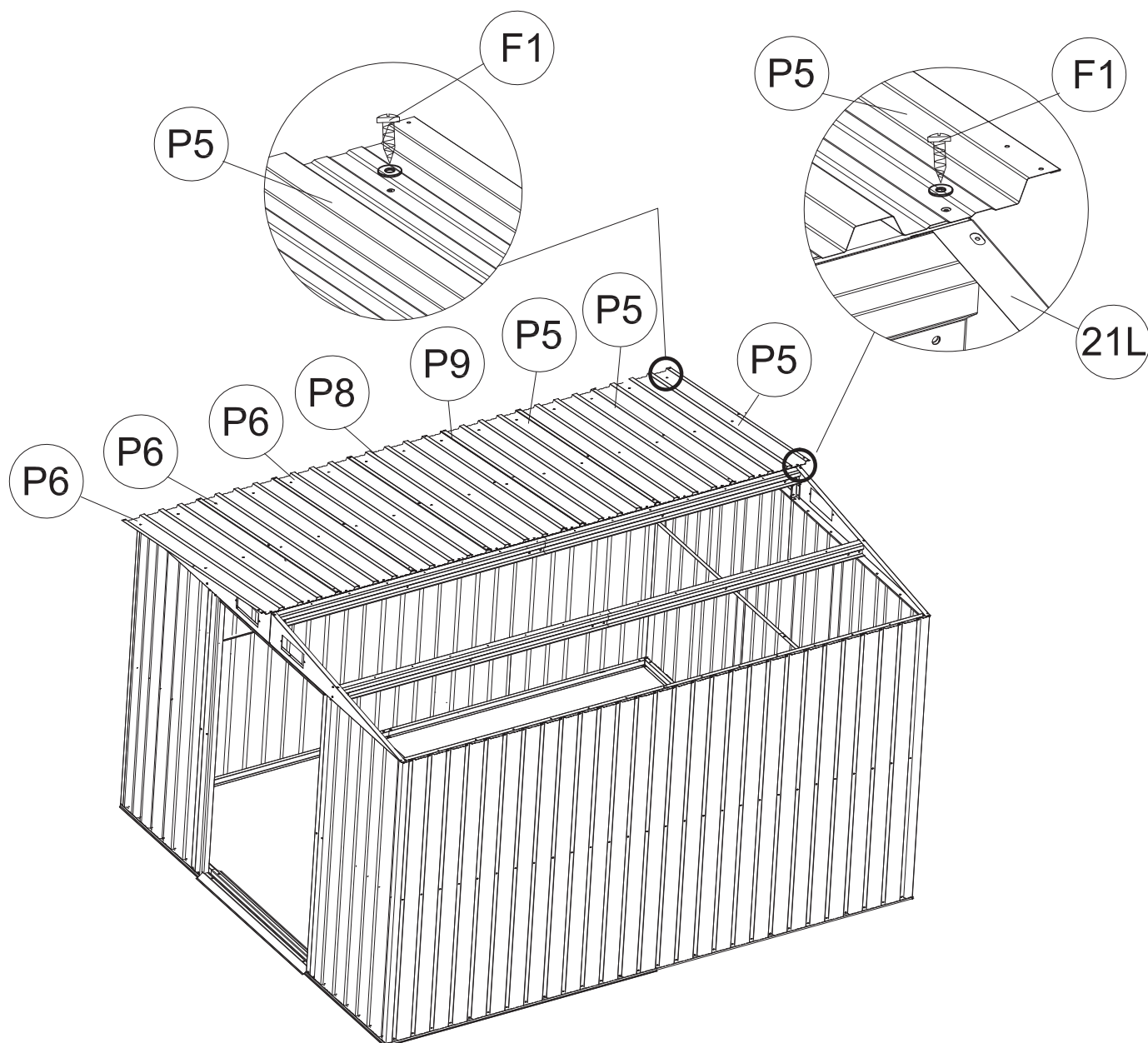
DETAIL	NUMBER	KOGUS
	F1	28

Katuse paigaldus -1





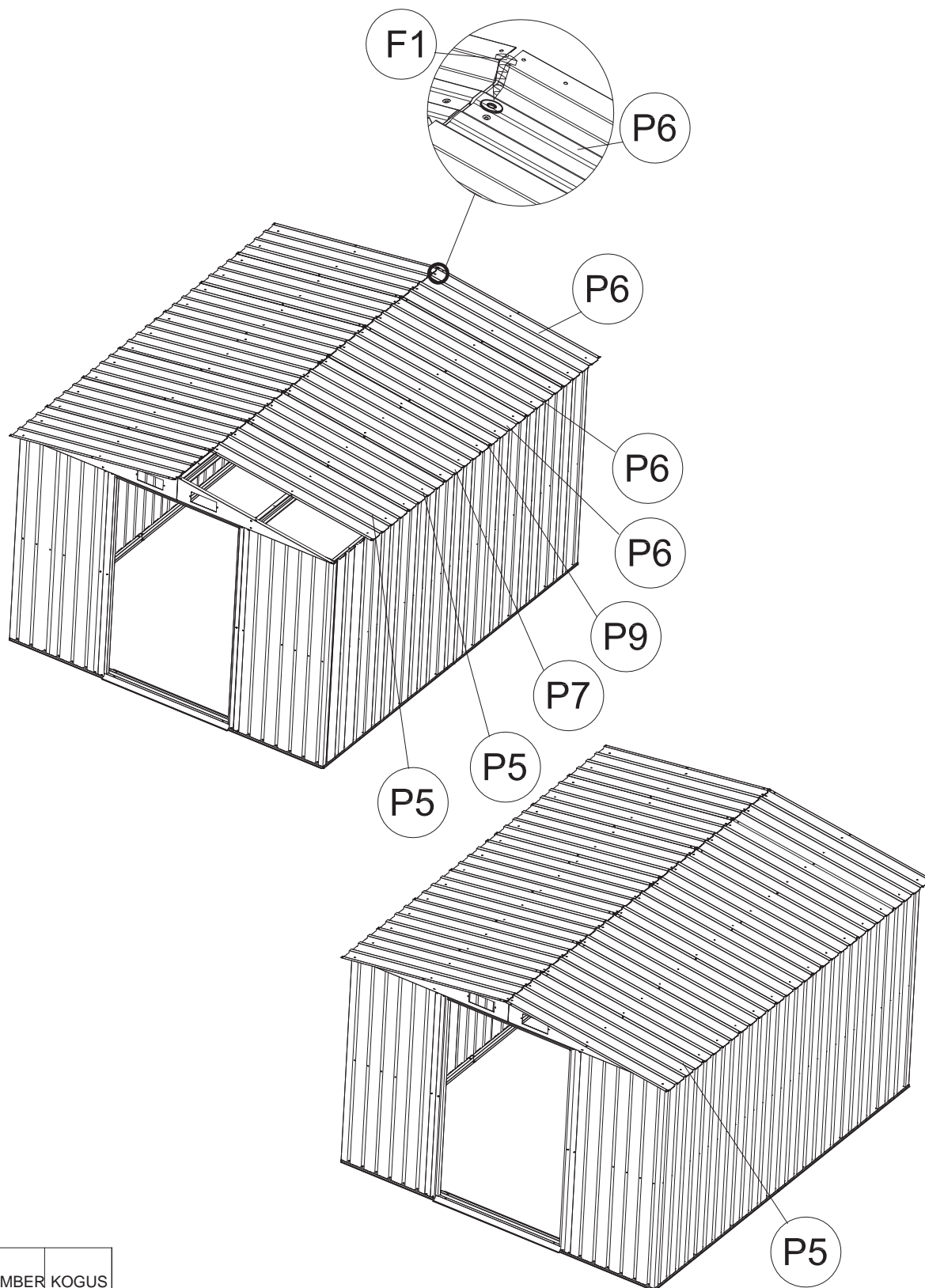

DETAIL	NUMBER	KOGUS			
	P5	3			
	P6	3		P9	1
	P8	1		F1	45

Paigaldage katusepaneelid (P5),(P6),(P8) ja (P9) viilupaneeli peale. Seadke augud kohakuti (F1) kruvidega.

Katuse paigaldus -2



DETAIL	NUMBER	KOGUS			
	P5	3			
	P6	3		P9	1
	P7	1		F1	45

Paigaldage katusepaneelid (P5),(P6),(P8) ja (P9) viilupaneeli peale. Seadke augud kohakuti (F1) kruvidega.

Katuse servalattide paigaldus

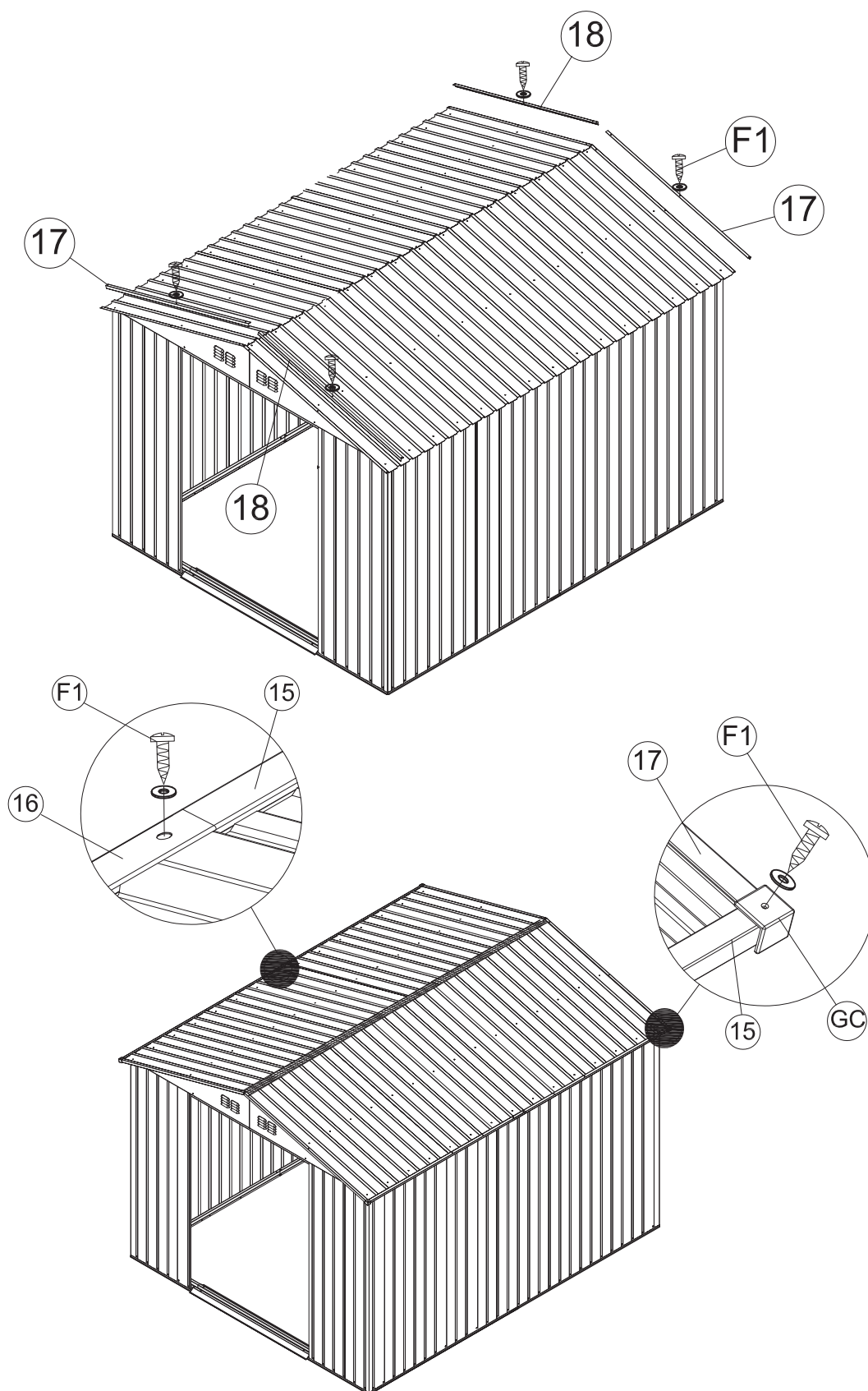



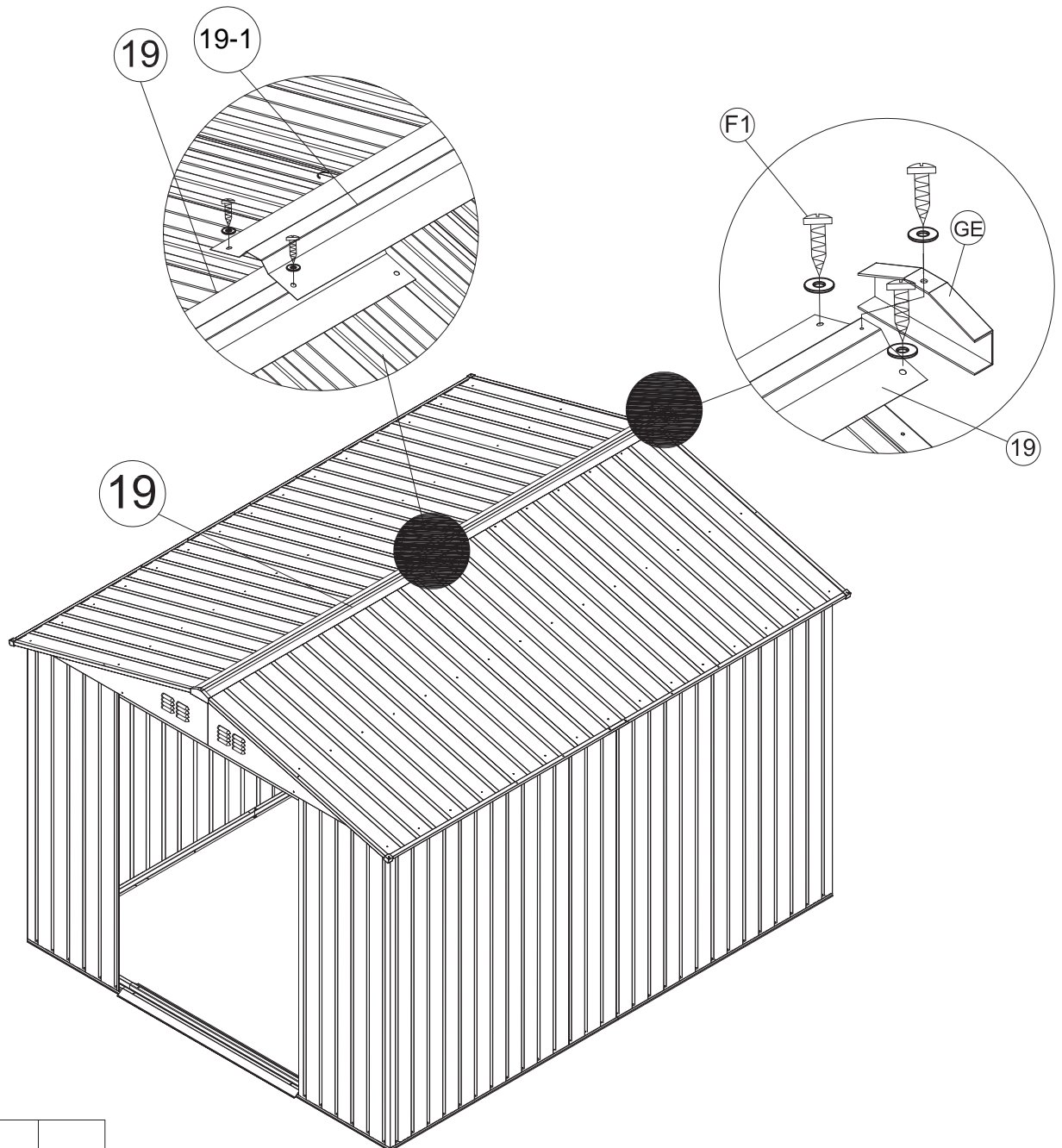

DETAIL	NUMBER	KOGUS
	15	4
	16	2
	17	2
	18	2
	GC	4
	F1	12

Asetage katuse servalattid (15),(16) and (17),(18) katusepaneelide külge kruvidega. Seejärel kinnitage 4 nurka servalattide külge (GC) kruvidega.

Katuseharja paigaldus



DETAIL	NUMBER	KOGUS
	19	2
	GE	2
	F1	10
	19-1	1

Asetage kaks katuse servalatti katusepaneelide külge kruvidega. Seejärel kinnitage servlatt (GE) katuse paneeli külge kruvidega.

Ukse paigaldus - 1

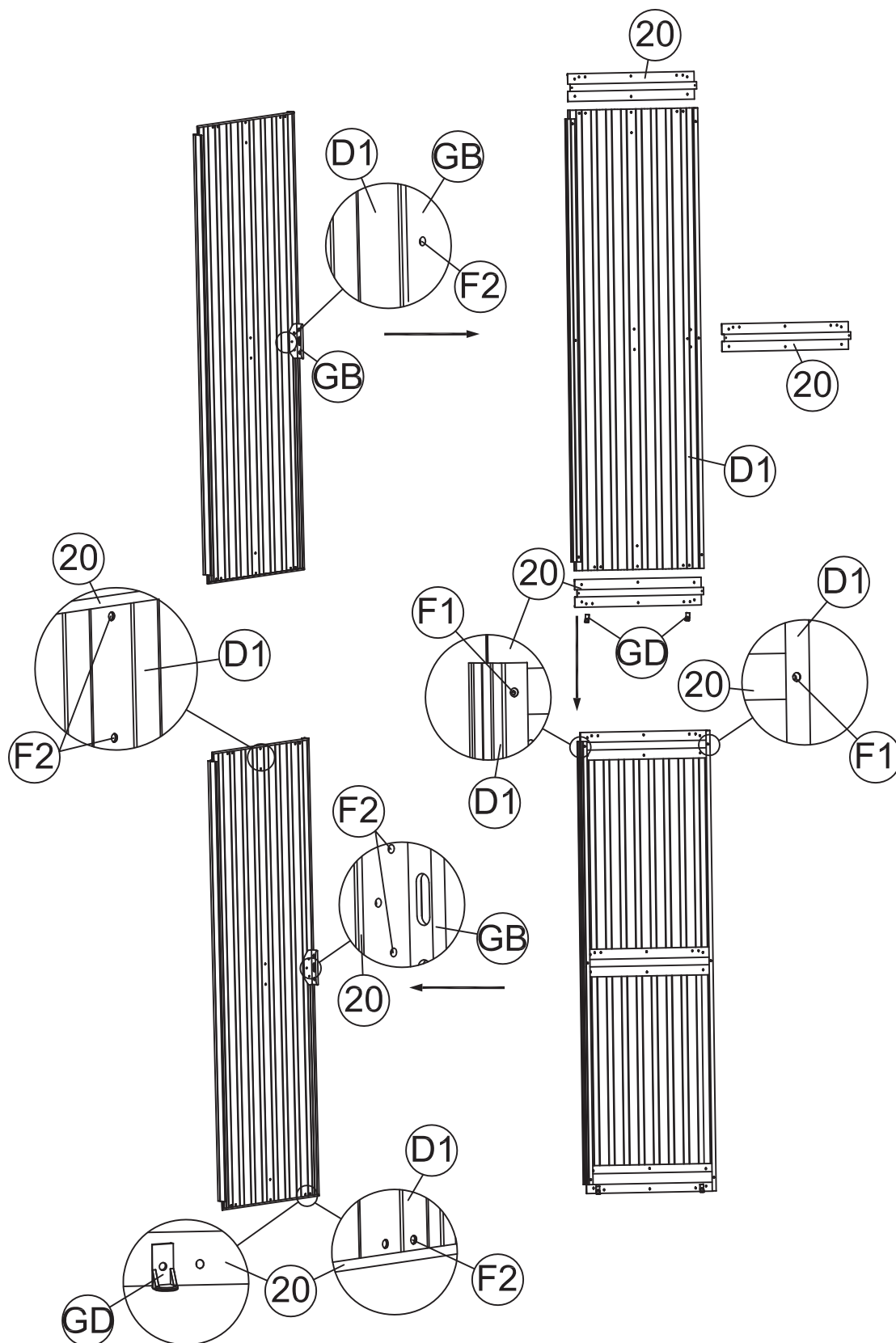

DETAIL	NUMBER	KOGUS
	20	3
	D1	1
	GB	1
	GD	2
	F1	6
	F2	11

Monteerige ukse latt (20) uksepaneelide (D1) külge. Seejärel paigaldage alumine liugur (GD) (GD) ukse latti (20) külge mõlemas alumises servas.

Ukse paigaldus - 2

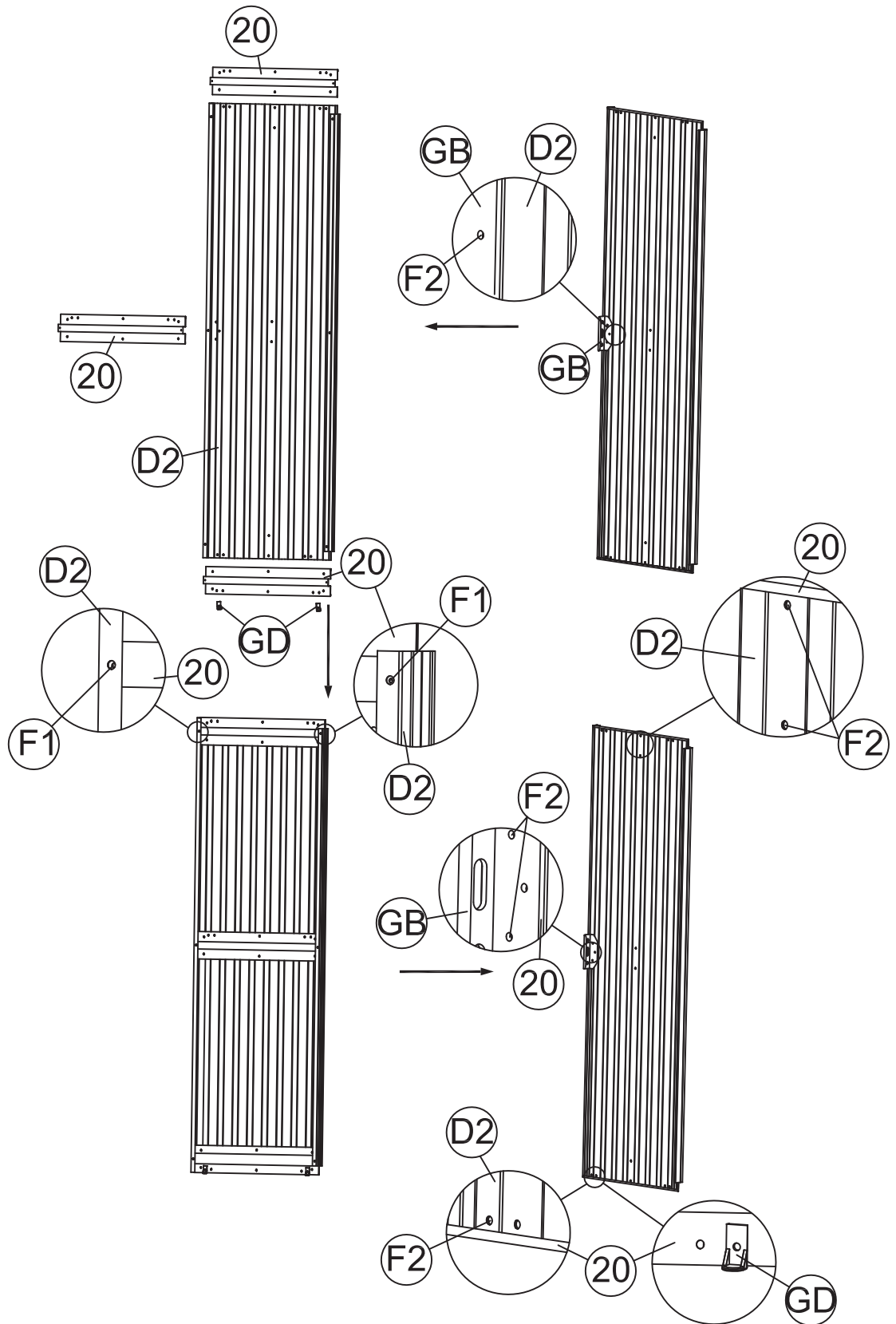



DETAIL	NUMBER	KOGUS
	20	3
	D2	1
	GB	1
	GD	2
	F1	6
	F2	11

Asetage ukselist (20) uksepaneeli külge (D2). Seejärel kinnitage alumine ligur (GB) (GD) ukselistu (20) mõlemalt küljest. Kinnitage kruvidega.

Katusepaneeli paigaldus

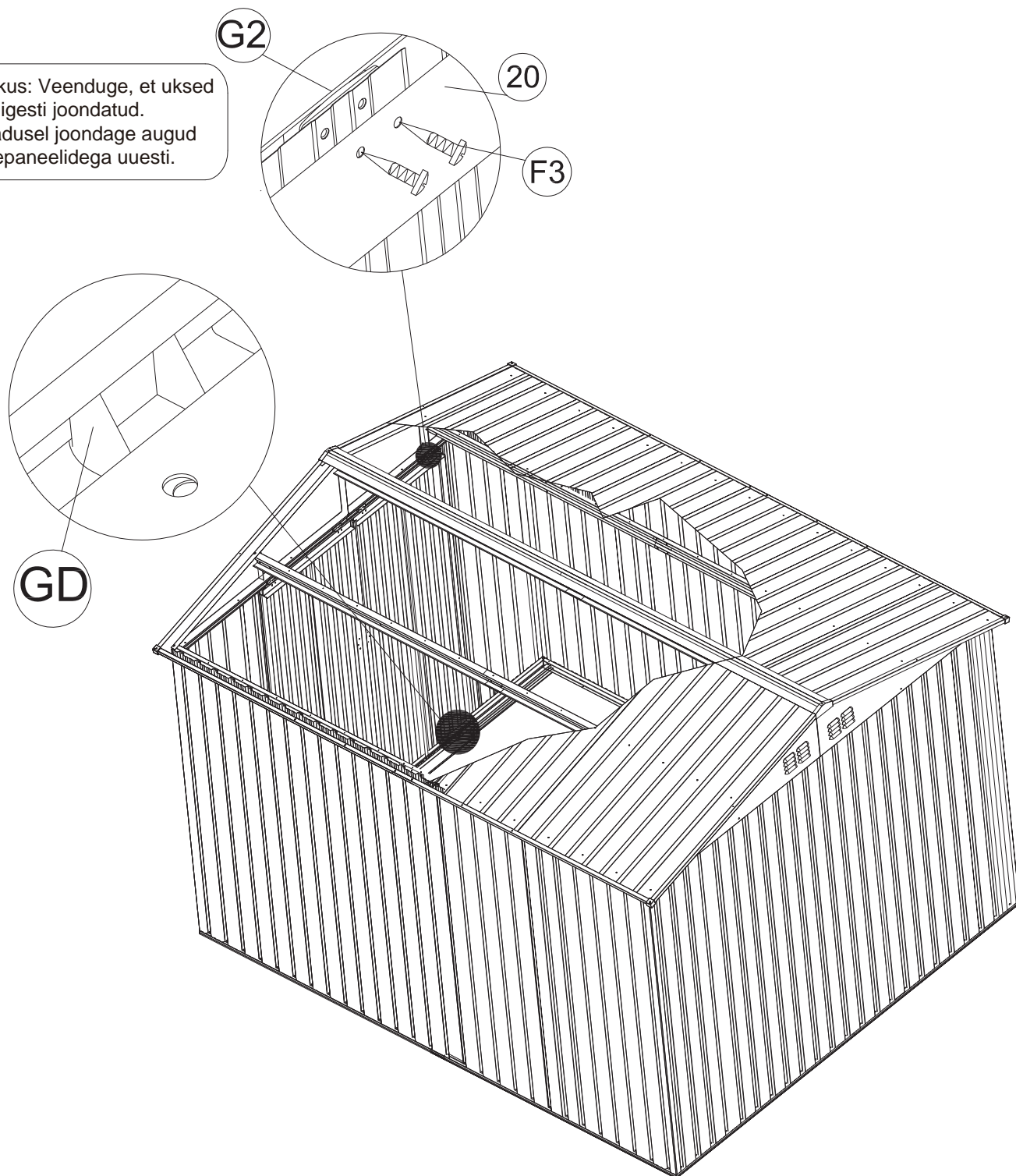
Märkus: Veenduge, et ukсед on õigesti joondatud.
Vajadusel joondage augud uksepaneelidega uuesti.



DETAIL	NUMBER	KOGUS
	F3	8

Lükake uksepaneel aluslati (3L) sisse. Veenduge, et põhjaliugur (GD) libiseb aluslati (3L) sees. Seejärel kinnitage uksepaneeli ülaosa ülemise liuguriga (G2), kasutades kruve (F3). Vt jooniseid

Karkassi hooldus

1. Karkass on valmistatud tsingitud lehtmaterjalist. Kui kõrgel temperatuuril ja niiskes keskkonnas tekib terase pinnale valgeid plekke, siis pühkige terase pinda lapiga.
2. Igasuguse deformatsiooni esinemisel tuleb viga kohe ära parandada, et vältida edasist deformeerumist.
3. Selleks, et vältida katusele kogunenud lumest tingitud kokkuvarisemist, peate lume alati eemaldama õigeaegselt.

Aiakuuri hooldus

1. Vältige aiakuuri kasutamise ajal teravaid esemeid, mis võivad põhjustada aiakuuri kahjustumist.
2. Värvitud terasplaadid on soovitatav välja vahetada pärast 6–10 aasta pikkust kasutamist.
3. Äikese ajal ärge jääge aiakuuri, sest tegemist on metallist toodetega, mis juhivad hästi elektrit ning võivad põhjustada tõsiseid tagajärgi. Ärge jääge äikese ajal aiakuuri, sest metallist tooted toimivad äikese ajal elektrijuhina, põhjustades raskeid tagajärgi.
4. Tugeva tuule (umbes 70 km/h) korral tuleb rakendada asjakohaseid kaitsemeetmeid ning kinnitada aiakuuri maa külge.