

FOREVER

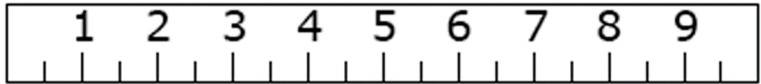

60min

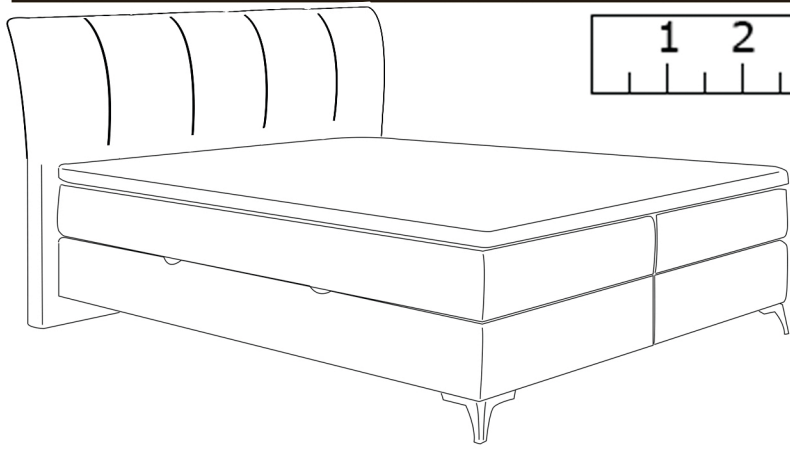
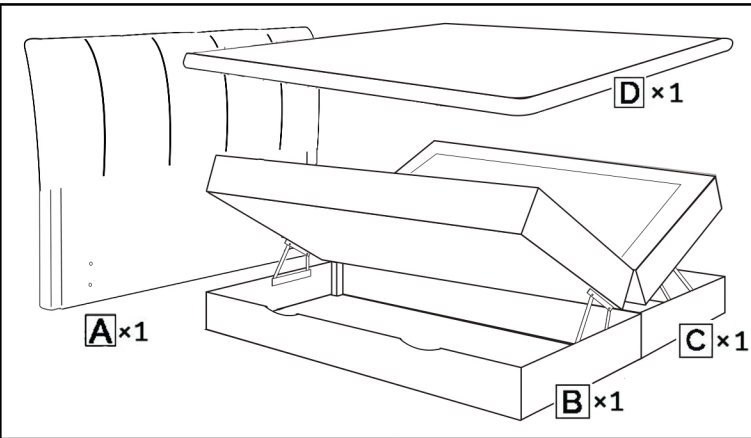
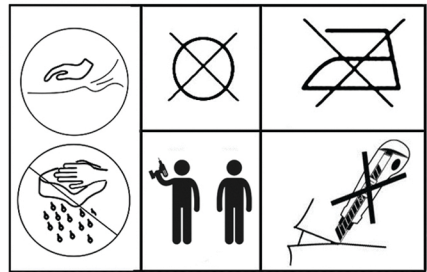
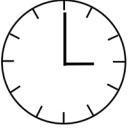

N x 2

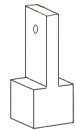

O x 2



P x 8



F x 4



H x 4



K x 2



L x 2

1

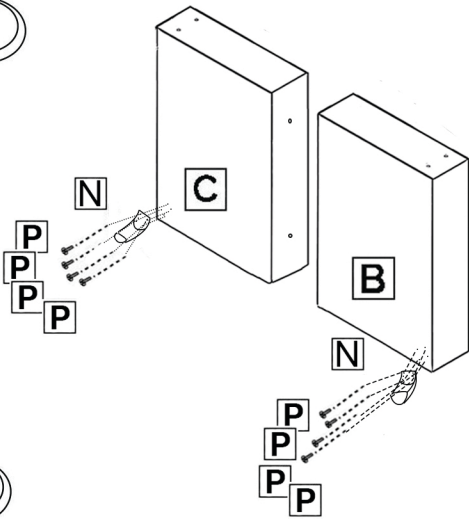

2

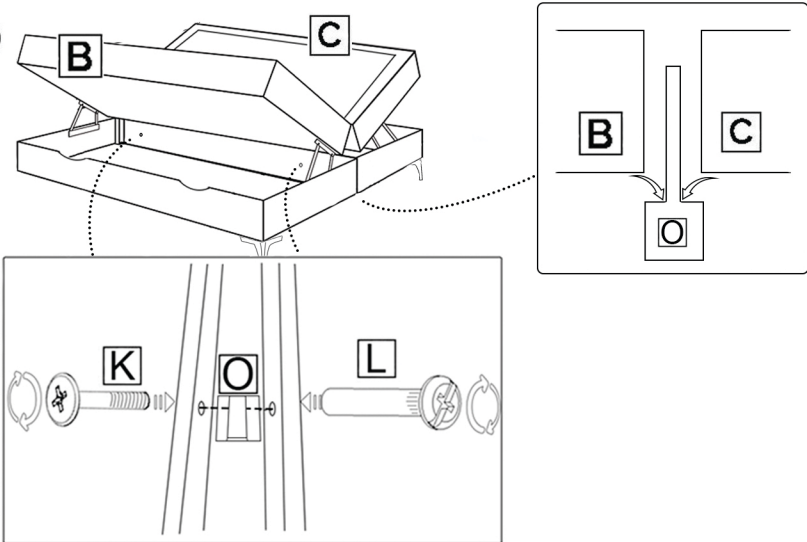

3

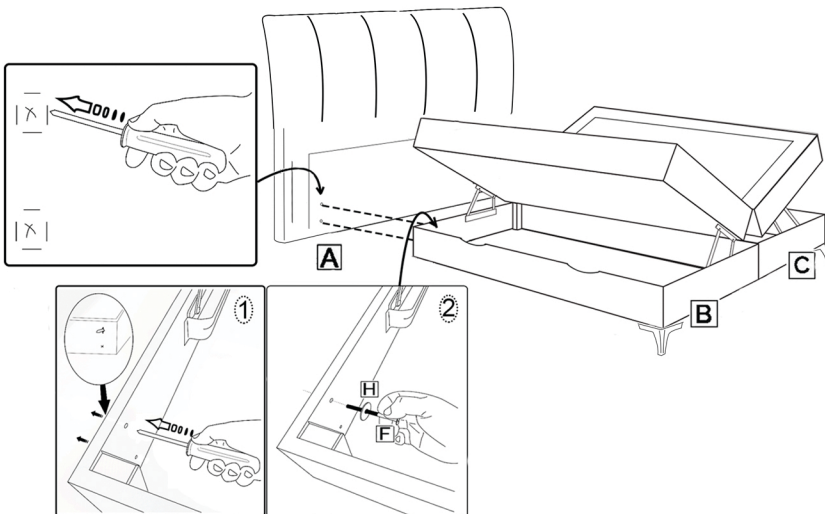

4

