

19/07/2021

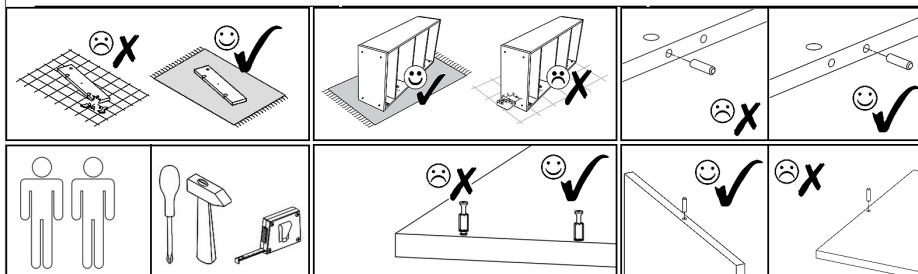

# MARBELA

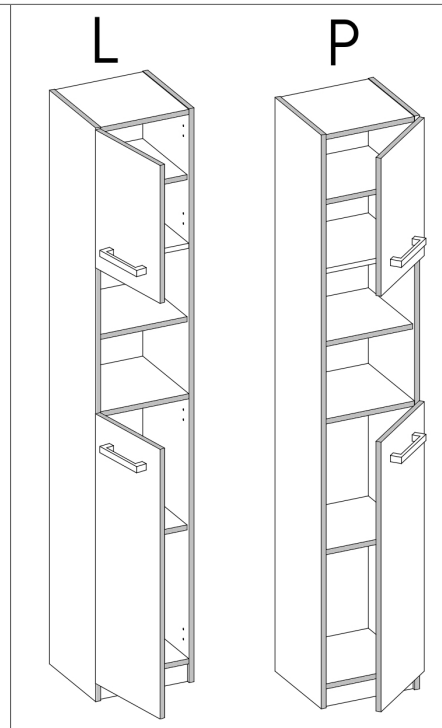

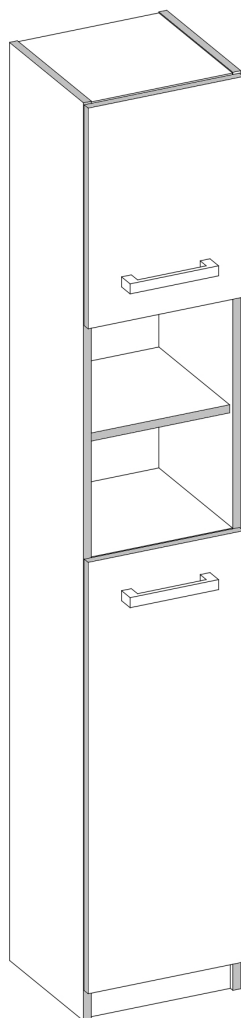
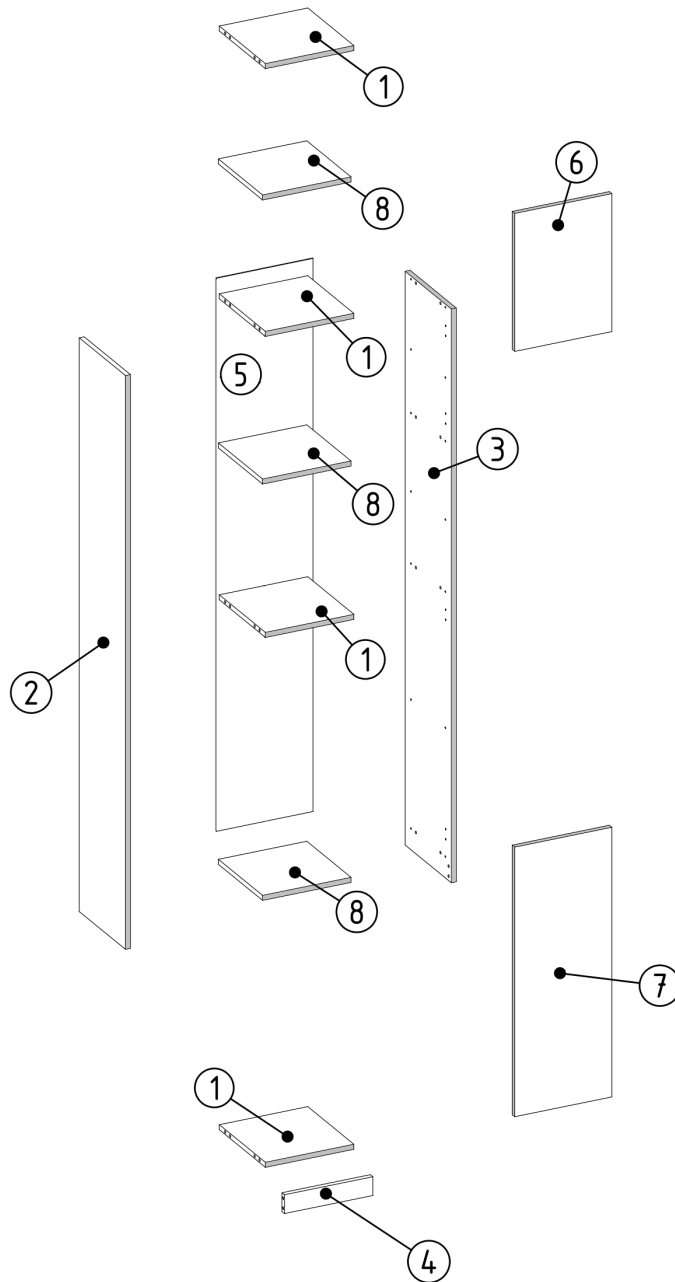

|                                    |                                     |                                    |                                     |                                    |                                   |
|------------------------------------|-------------------------------------|------------------------------------|-------------------------------------|------------------------------------|-----------------------------------|
| <b>N1</b><br><br>L=35mm <b>x16</b> | <b>M1</b><br><br>12x15mm <b>x16</b> | <b>U1</b><br><br>L=180mm <b>x2</b> | <b>S1</b><br><br>3.5x16mm <b>x8</b> | <b>E1</b><br><br>8x30mm <b>x20</b> | <b>S5</b><br><br>4x27mm <b>x4</b> |
| <b>T1</b><br><br><b>x4</b>         | <b>Z1</b><br><br><b>x50</b>         | <b>A1</b><br><br>ZP <b>x4</b>      | <b>K7</b><br><br>L=16mm <b>x12</b>  | <b>M2</b><br><br>ø16mm <b>x8</b>   | <b>K2</b><br><br><b>x1</b>        |

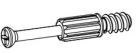

|          |   |   |
|----------|---|---|
| <b>1</b> | x | 4 |
| <b>2</b> | x | 1 |
| <b>3</b> | x | 1 |
| <b>4</b> | x | 1 |
| <b>5</b> | x | 1 |
| <b>6</b> | x | 1 |
| <b>7</b> | x | 1 |
| <b>8</b> | x | 3 |

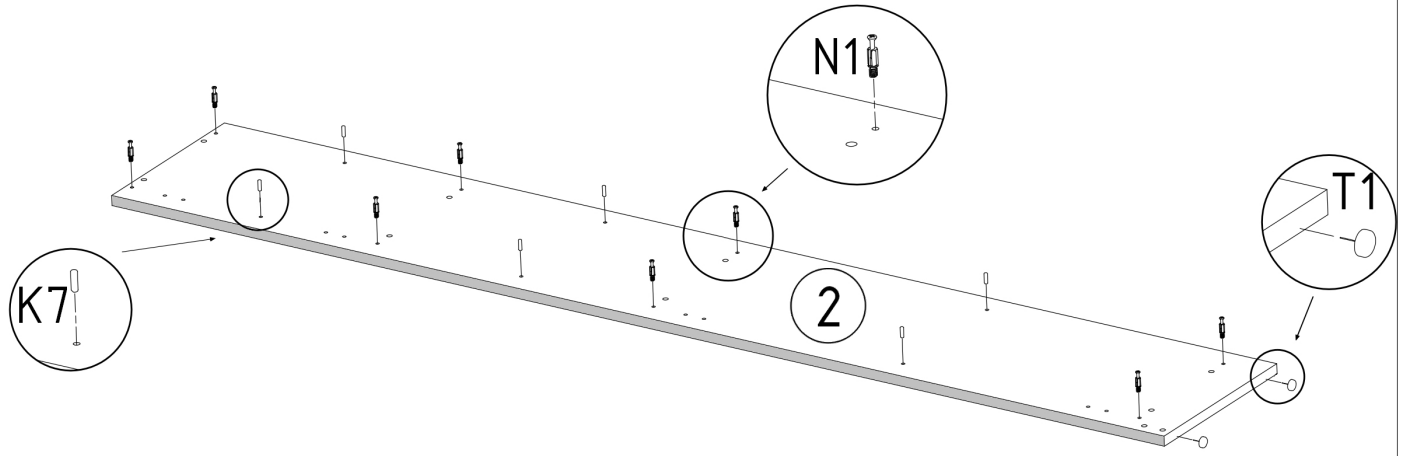
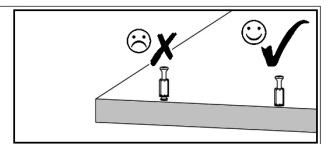
|  |  |   |
|--|--|---|
| <b>N1</b><br><br>L=35mm x8 | <b>K7</b><br><br>L=16mm x6 | <b>T1</b><br><br>x2 |
|--|--|---|

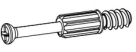

|   |   |  |
|---|---|--|
| <b>N1</b><br><br>L=35mm x8 | <b>K7</b><br><br>L=16mm x6 | <b>T1</b><br><br>x2 |
|---|---|--|

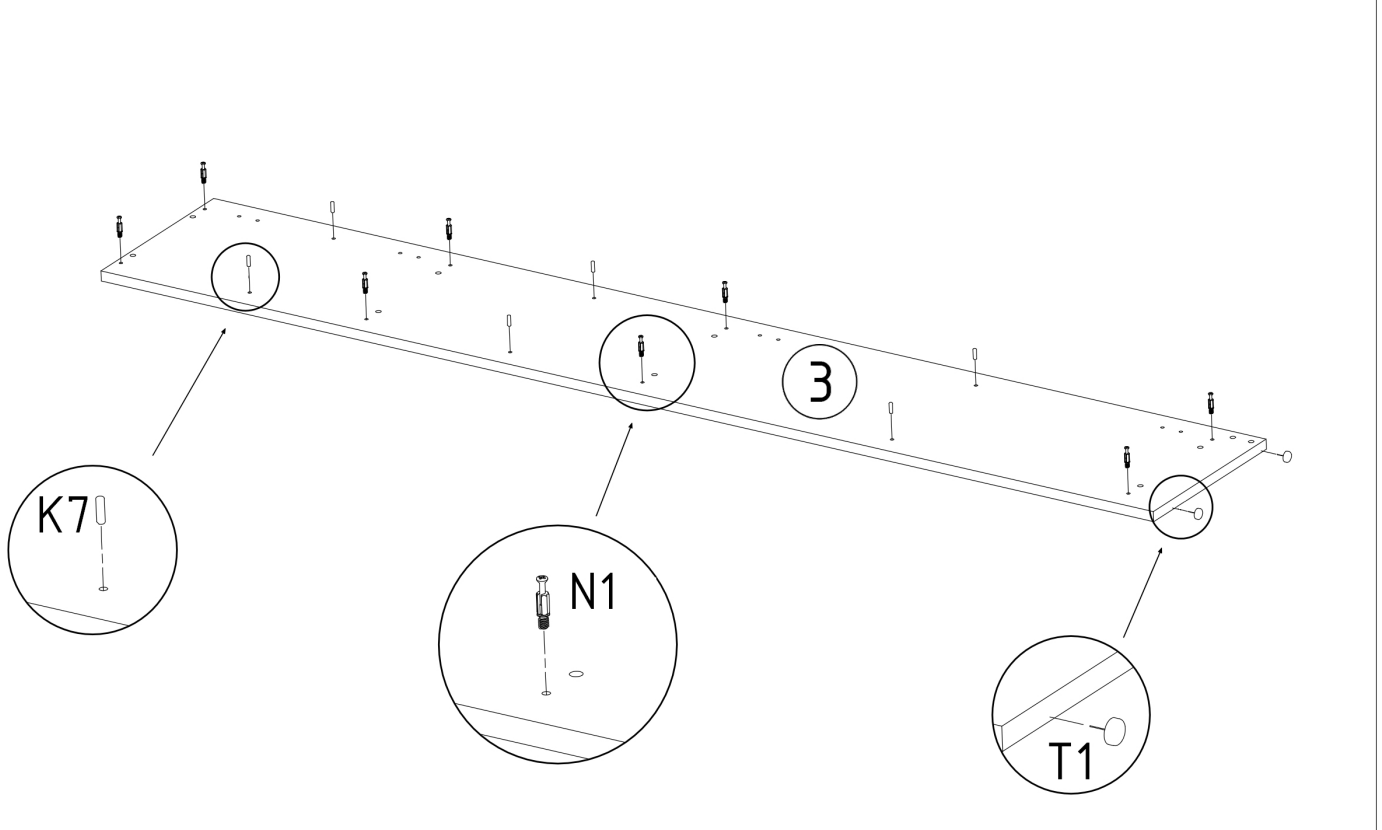
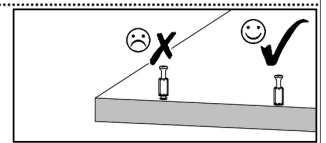

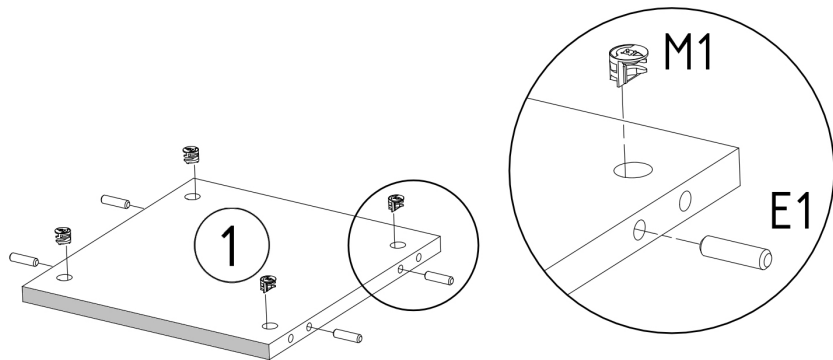
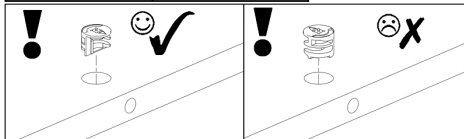
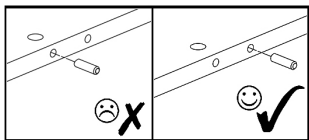
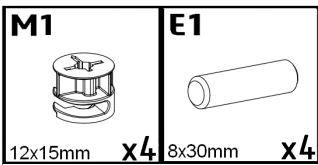

**x4**

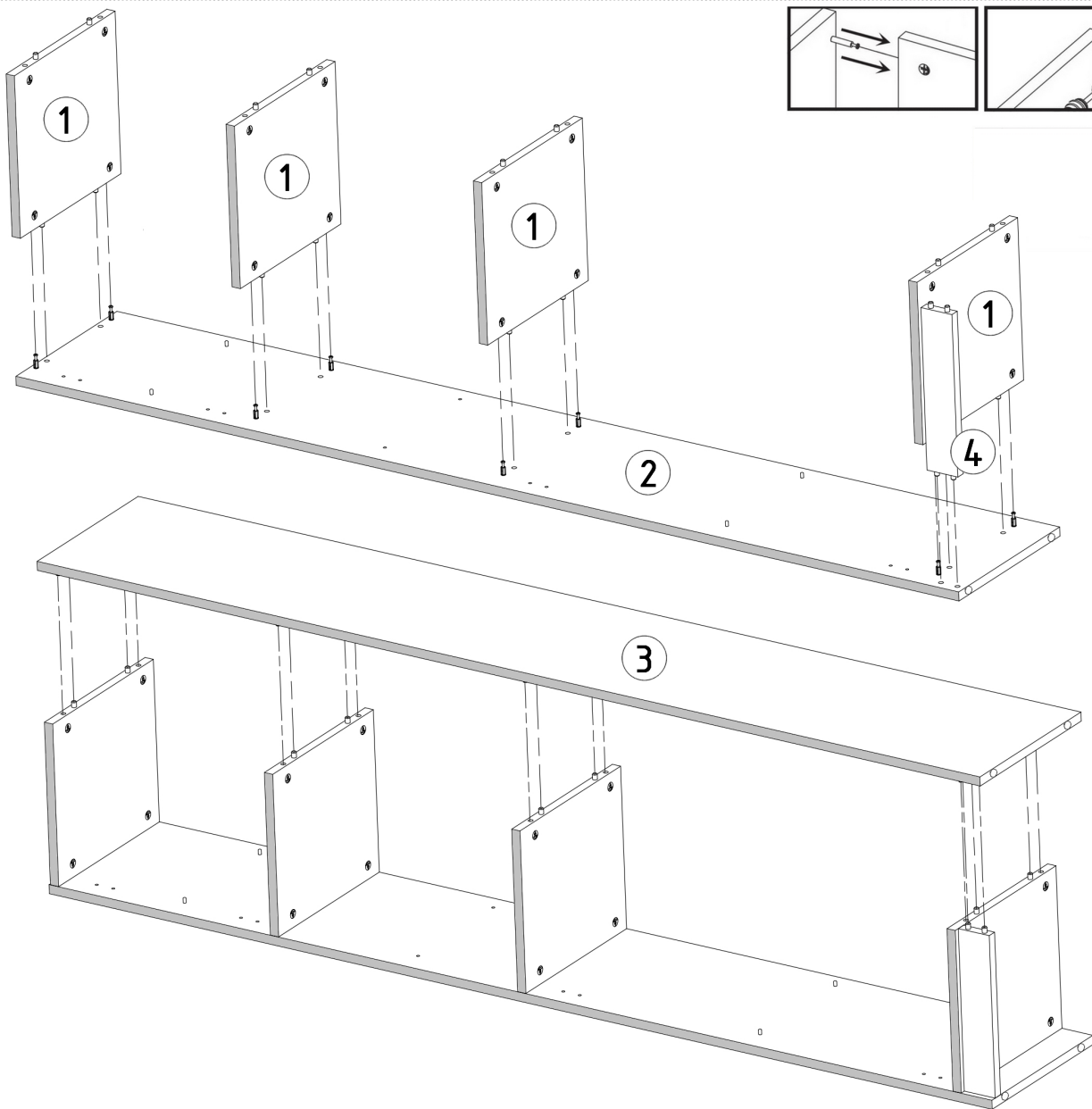
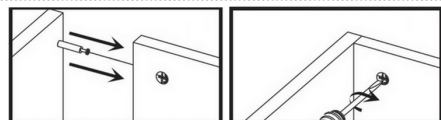
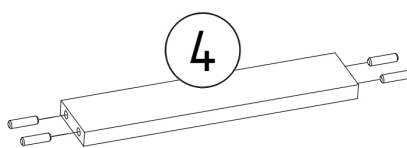
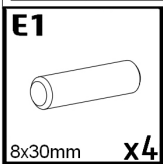

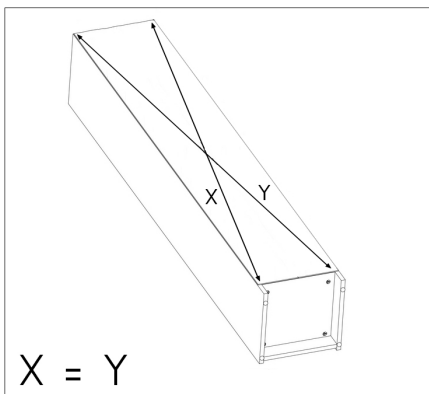
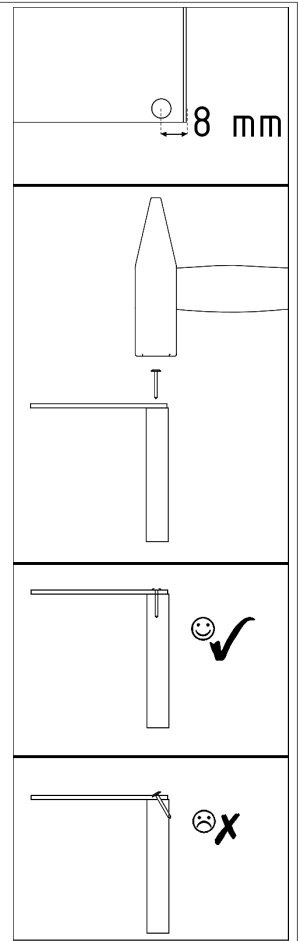
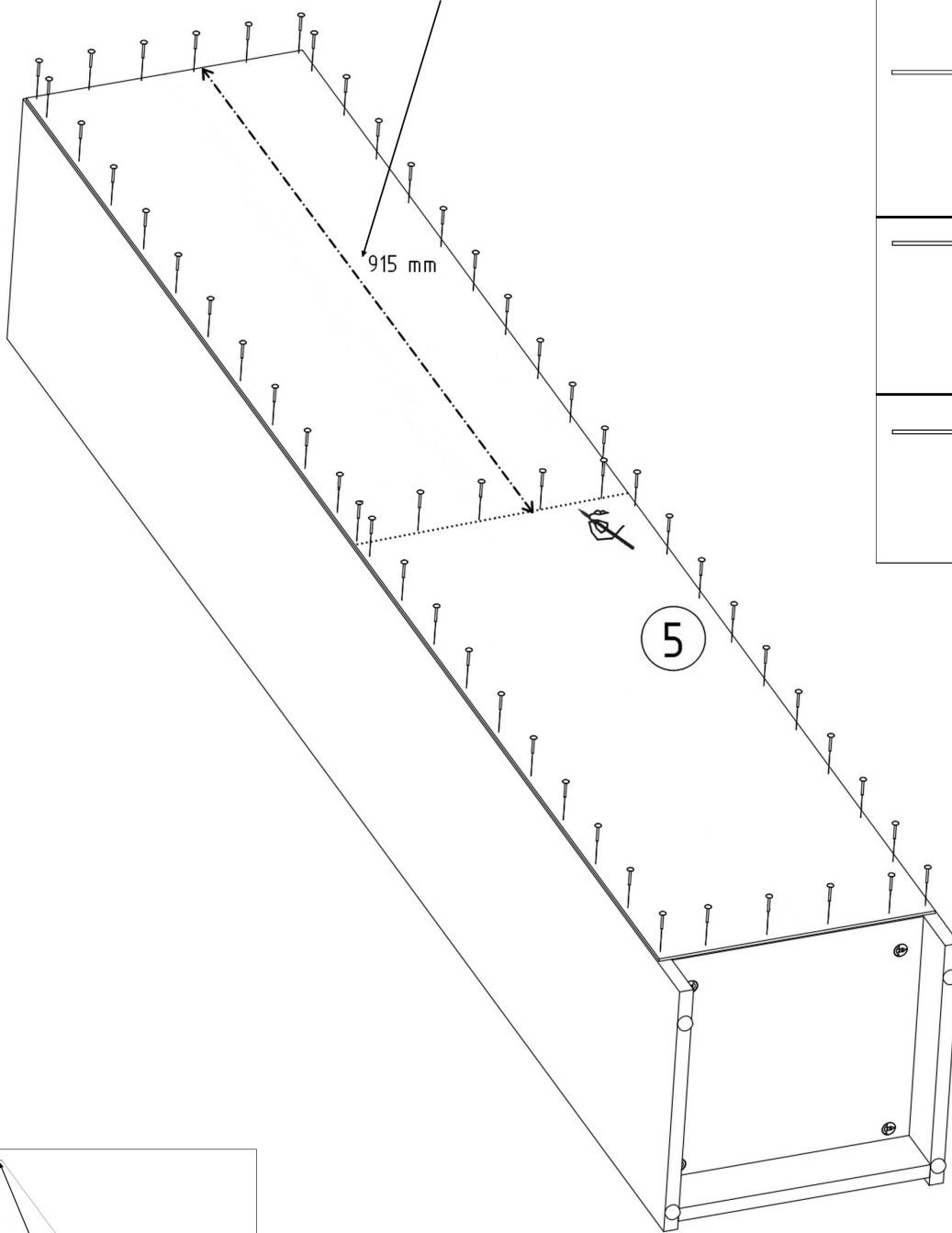
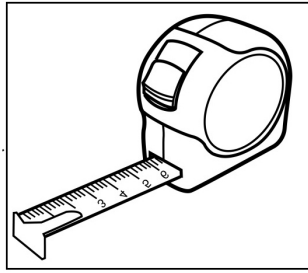

Z1  
x 50

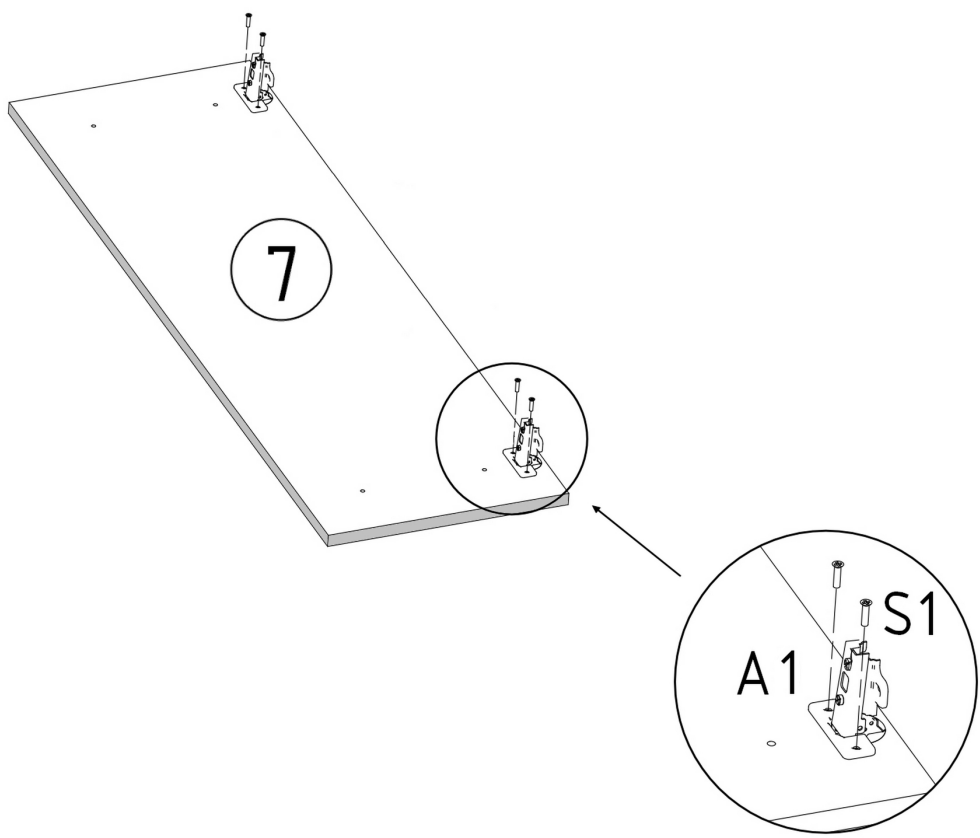
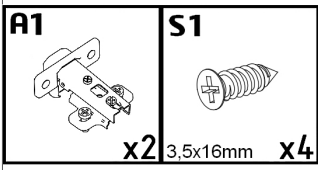
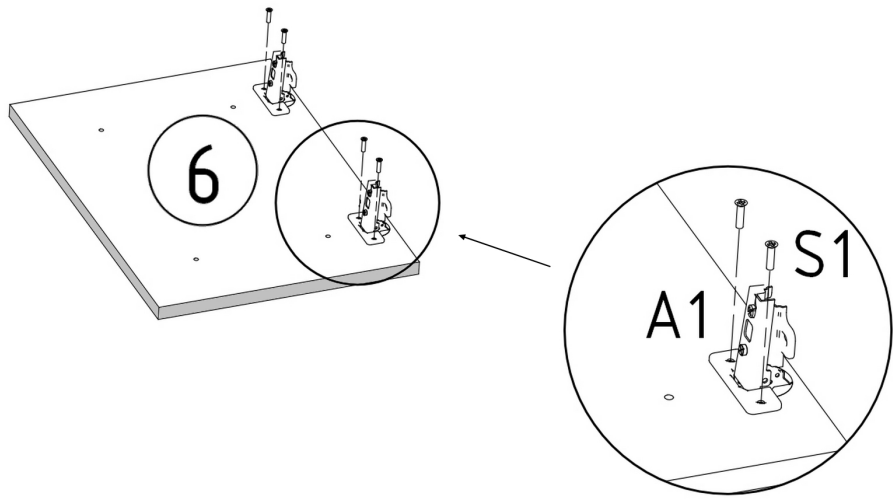
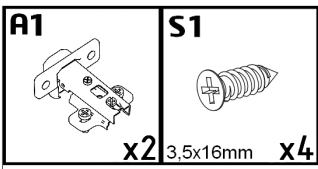

X = Y

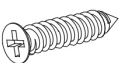
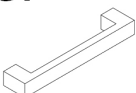

|  |   |  |  |           |
|--|---|--|--|-----------|
| <b>K2</b><br><br><b>x1</b> | <b>S5</b><br><br><b>x4</b> 4x27mm | <b>U1</b><br><br><b>x4</b> L=180mm | <b>M2</b><br><br><b>x2</b> ø16mm | <b>x8</b> |
|--|---|--|--|-----------|

