

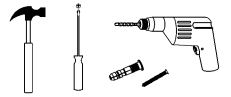

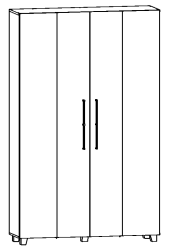









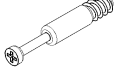









TEDDY 120

L-135 H-216 D-42

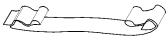

 120 min

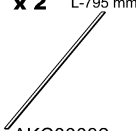
<p>x 14</p>  <p>AKC00120</p>	<p>x 14</p>  <p>AKC00004</p>	<p>x 12</p>  <p>AKC00029</p>	<p>x 12</p>  <p>AKC00151</p>	<p>x 12</p>  <p>AKC00004</p>	<p>x 8</p>  <p>ZAW00017</p>	
<p>x 6</p>  <p>ZAW00016</p>	<p>x 6</p>  <p>AKC00007</p>	<p>x 1</p>  <p>AKC00036</p>	<p>x 6</p>  <p>AKC00008</p>	<p>x 3</p>  <p>AKC00107</p>	<p>x 7</p>  <p>AKC00150</p>	
<p>x 63</p>  <p>3x16 AKC00026</p>	<p>x 23</p>  <p>3,5x16 AKC00026</p>	<p>x 6</p>  <p>4x25 AKC00026</p>	<p>x 6</p>  <p>AKC00085</p>	<p>x 100</p>  <p>AKC00018</p>	<p>x 1</p>  <p>AKC00017</p>	<p>x 4 L-1500 mm x 1 L-350 mm</p>  <p>TAP00187</p>
<p>x 5</p>  <p>NOG00015</p>	<p>x 2</p>  <p>UCH00017</p>	<p>x 2 L-795 mm</p>  <p>AKC00032</p>				

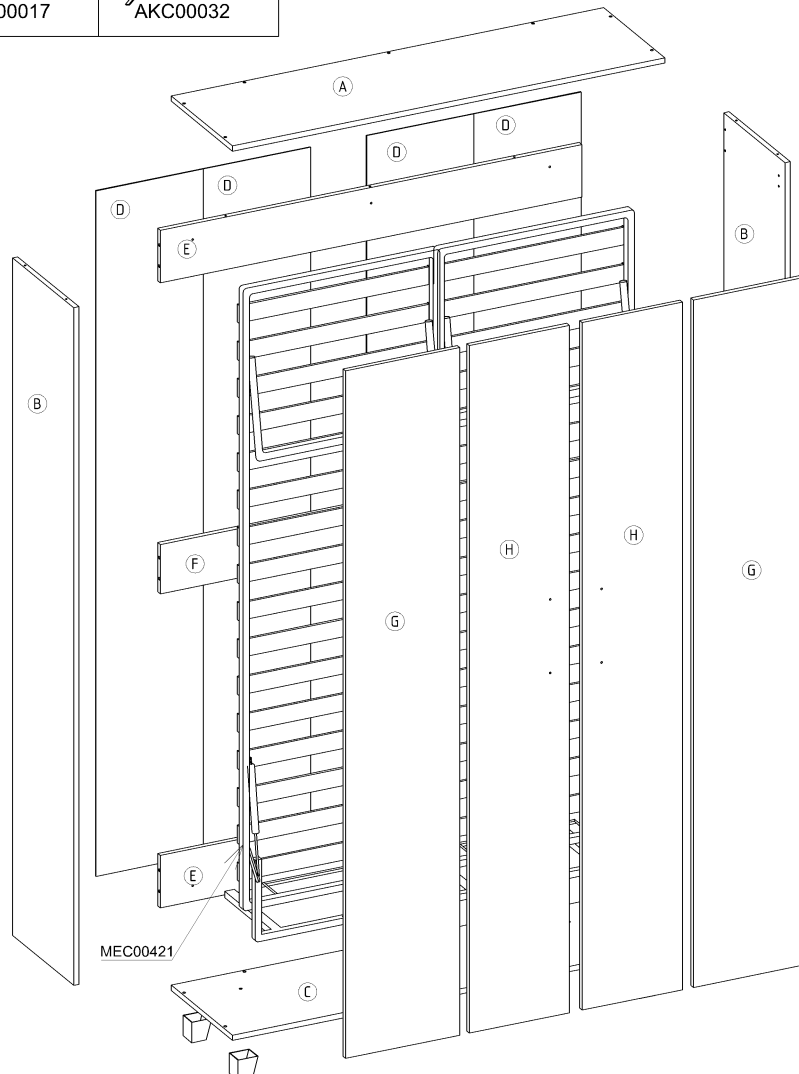

1

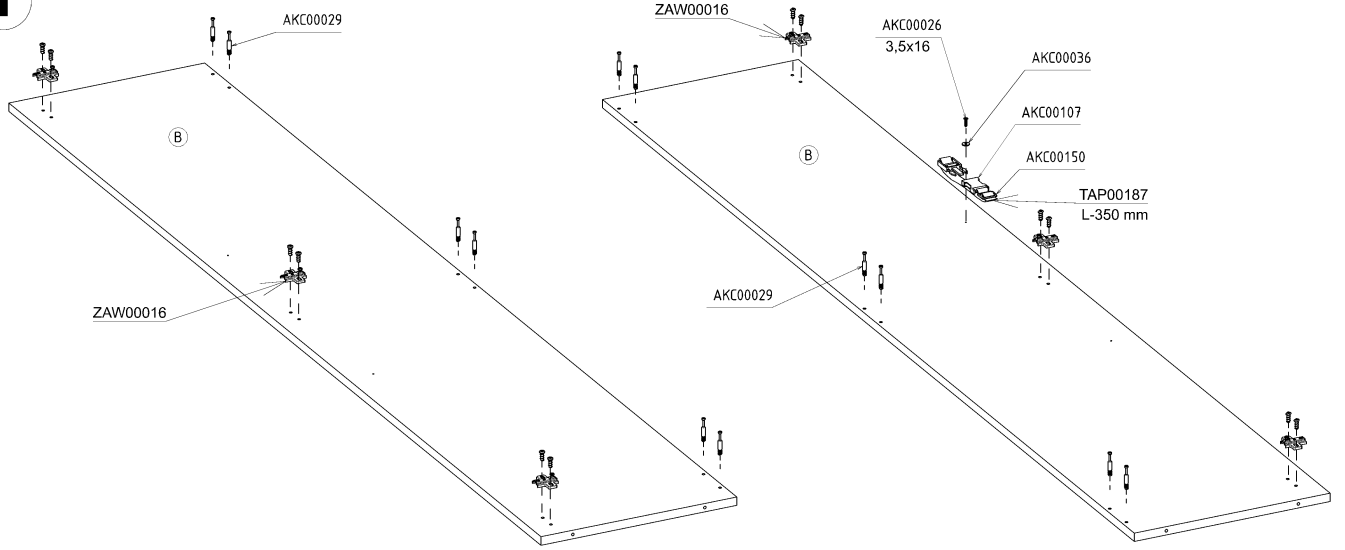

2

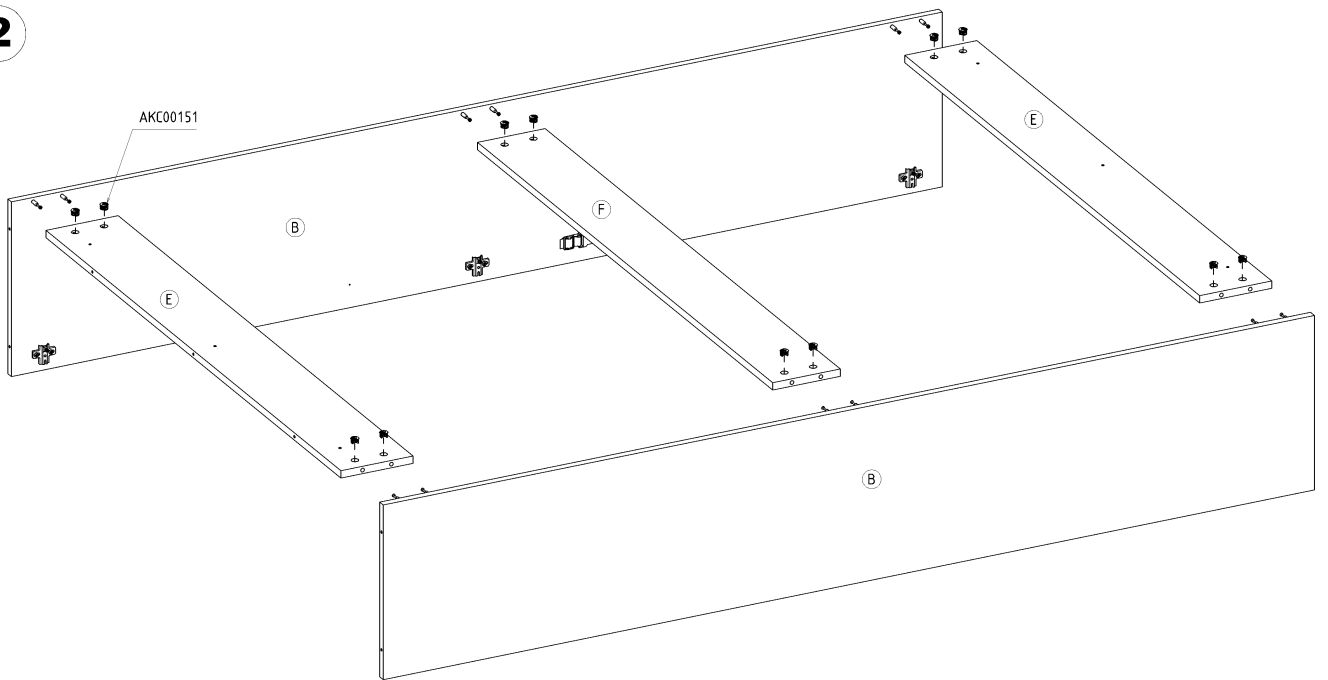

3

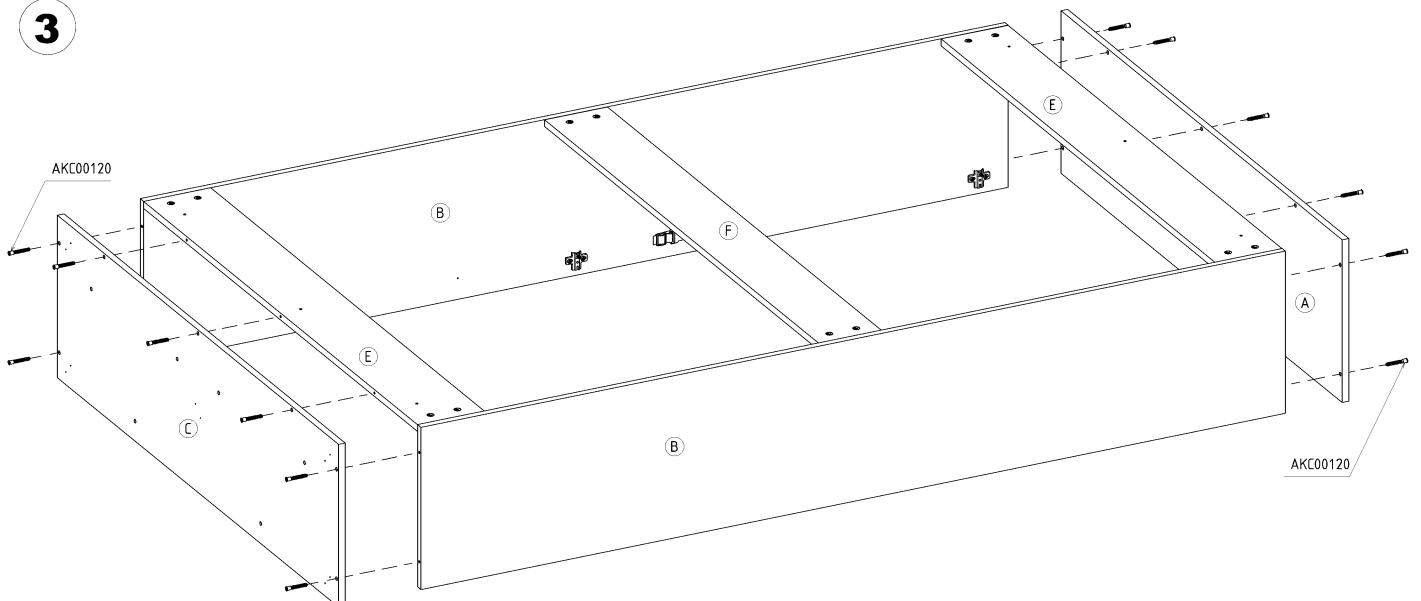

4

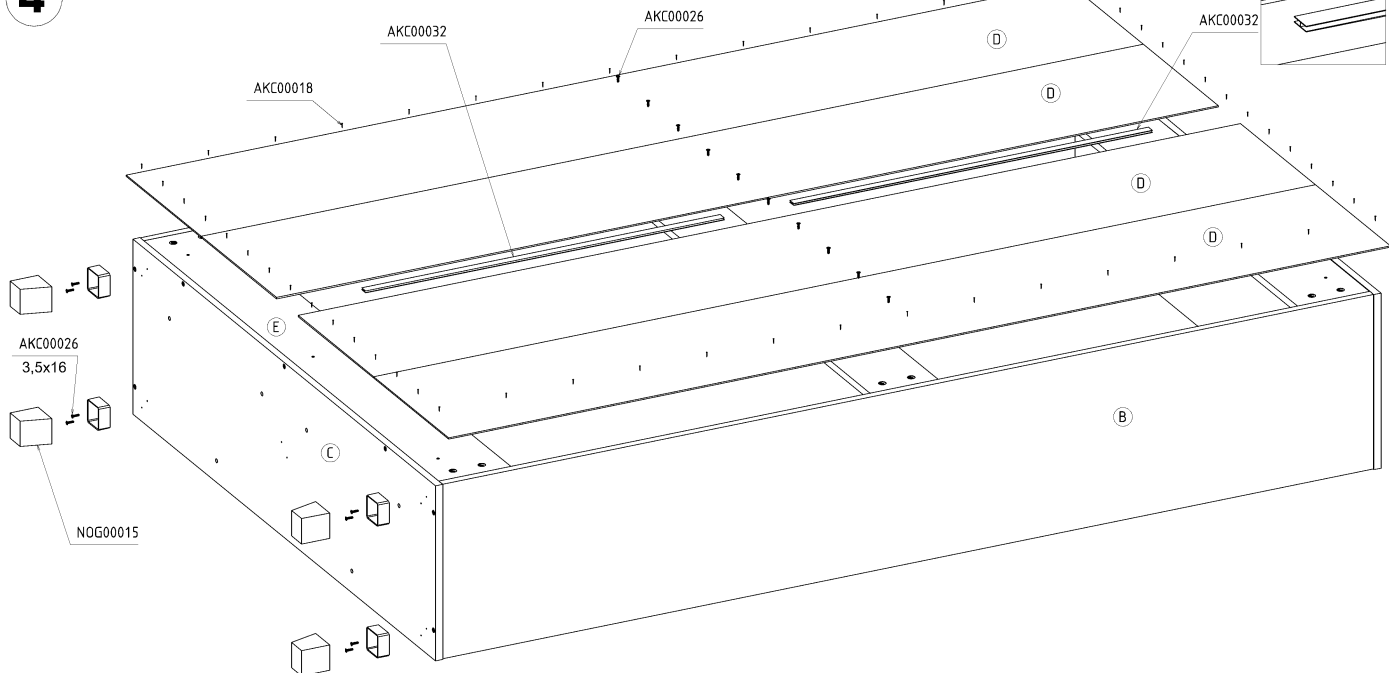

5

x 2

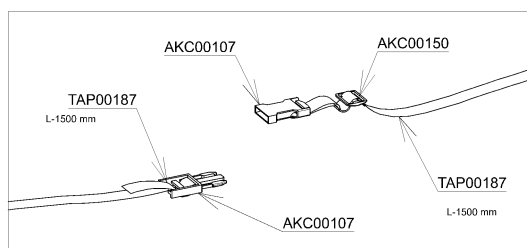

x 6

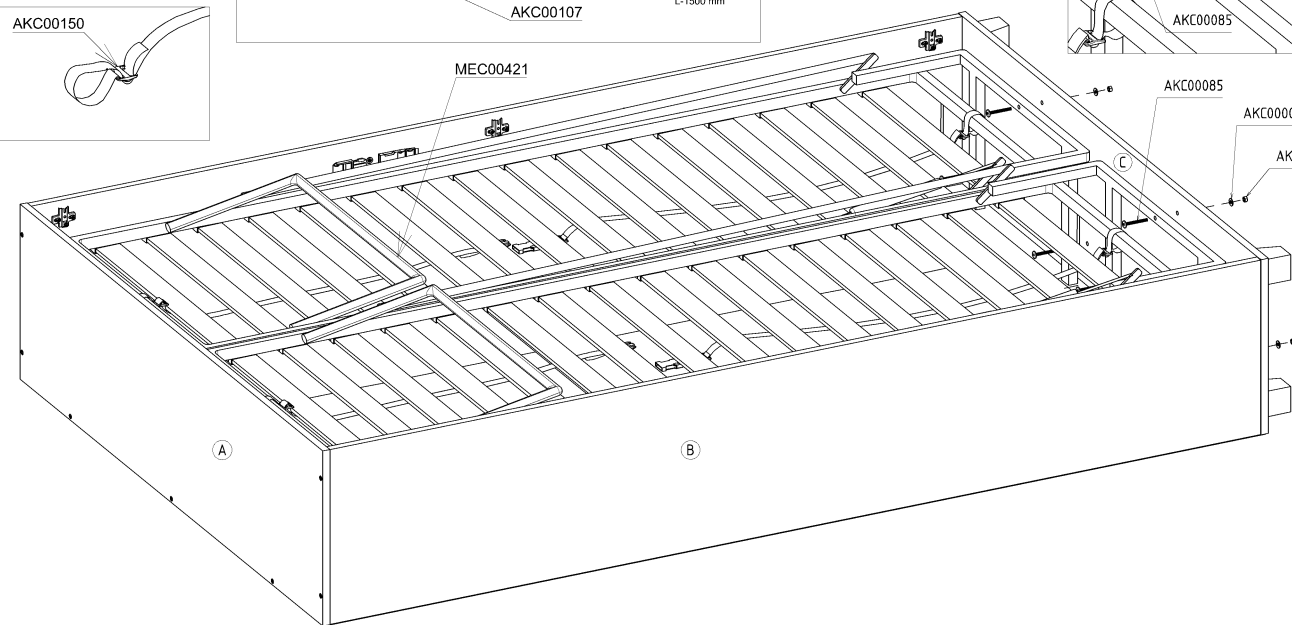
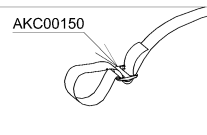
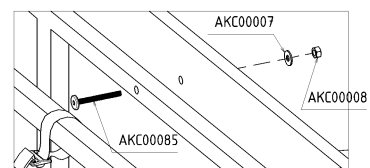

6

x 2

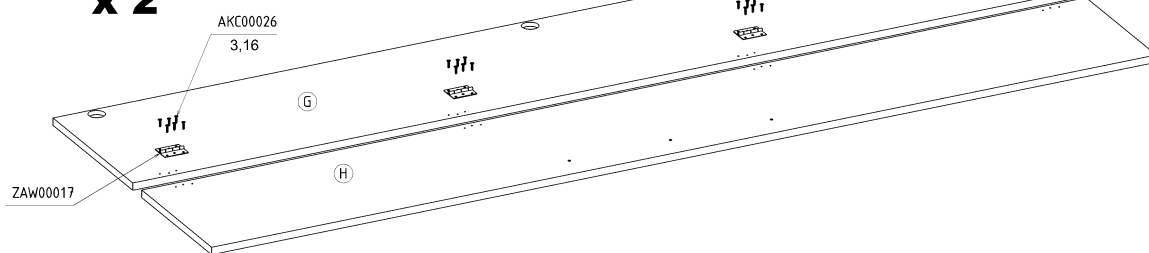

7

x 2

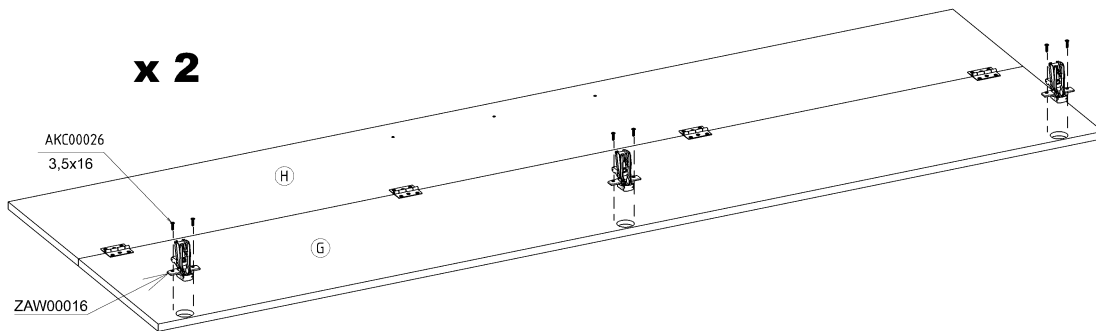

x 3



8

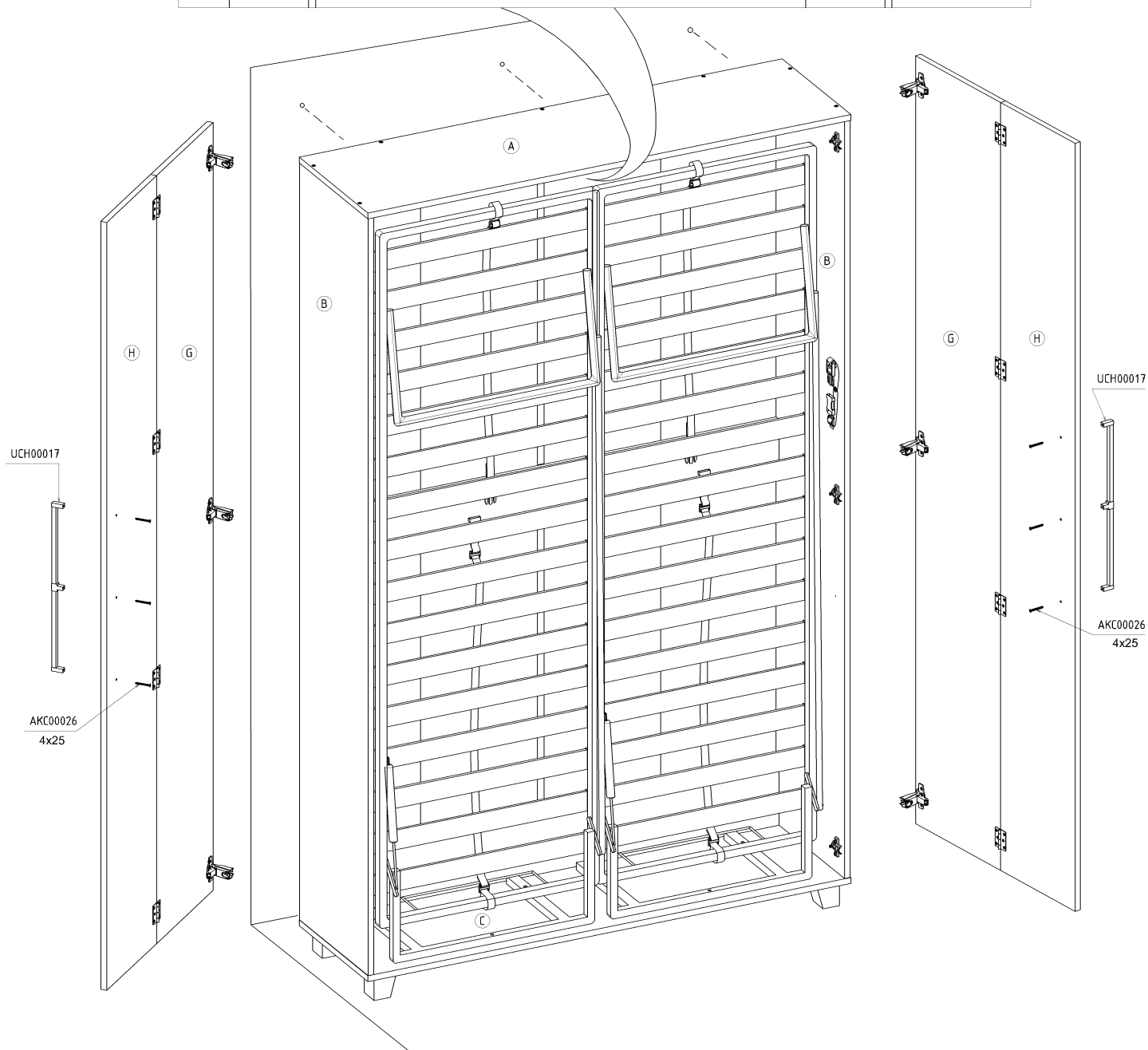
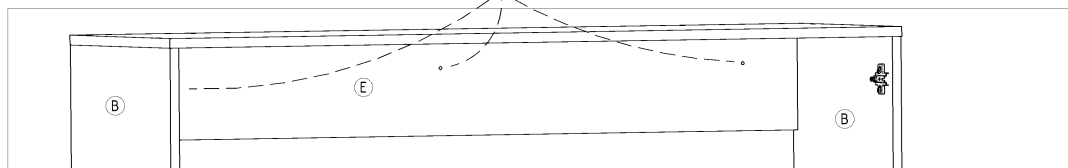

UCH00017

AKC00026
4x25