

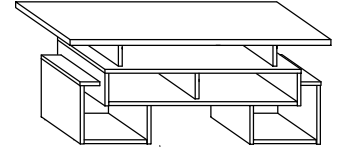

RIO-12
ŁAWA S
 → 110 ↑ 48 ↘ 62



x 15



(a)

x 26



(b)

x 26



(c)

x 14



(d)

x 8



(e)

x 1



(f)

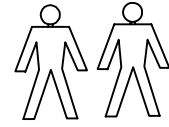
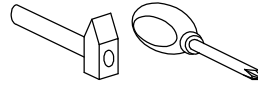

60 min



1 - FAZY MONTAŻU

A - OZNACZENIE ELEMENTÓW

a - OZNACZENIE AKCESORIÓW

1



(a)

x 14



(b)

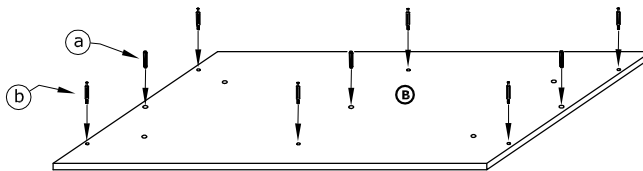
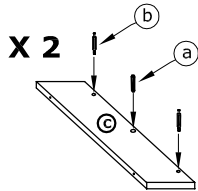
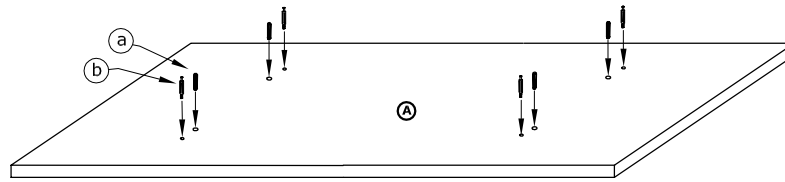

2



(a)

x 12



(b)



(e)

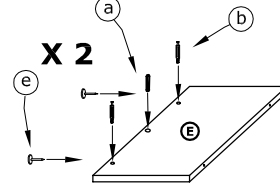
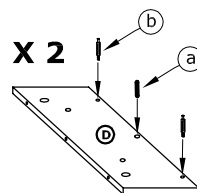
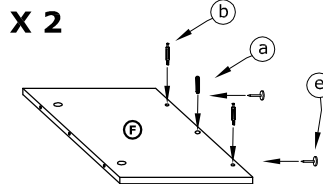

3



(c)



x 2

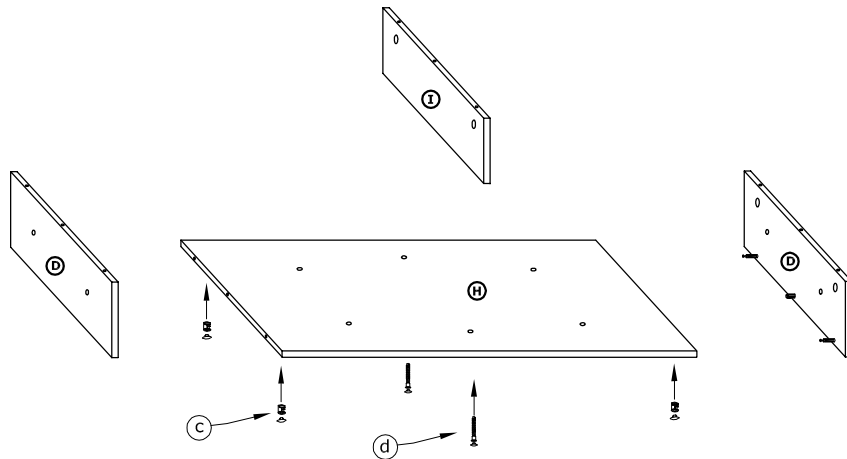

(d)



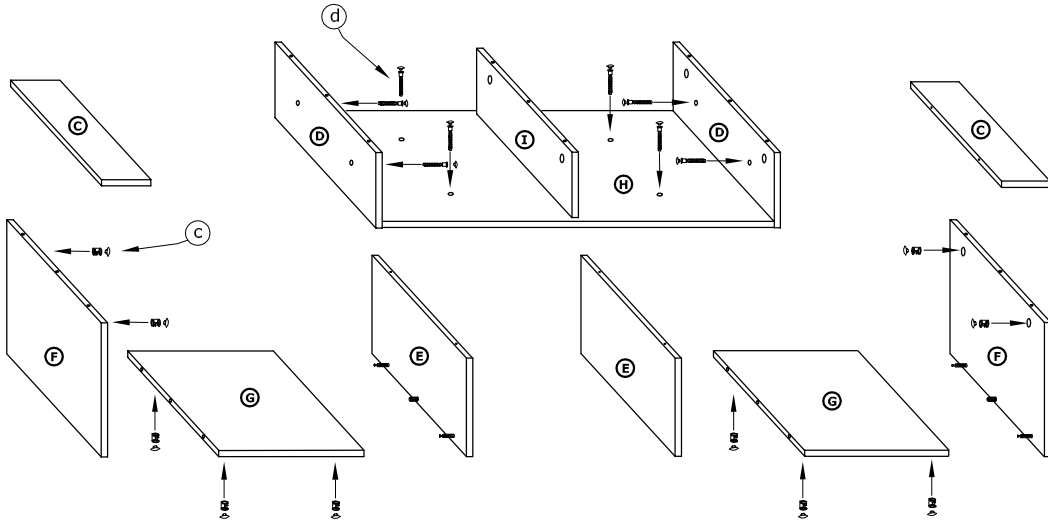

4

x 12	x 8
	
(c)	(d)



5

x 6	
(c)	
x 4	
(d)	

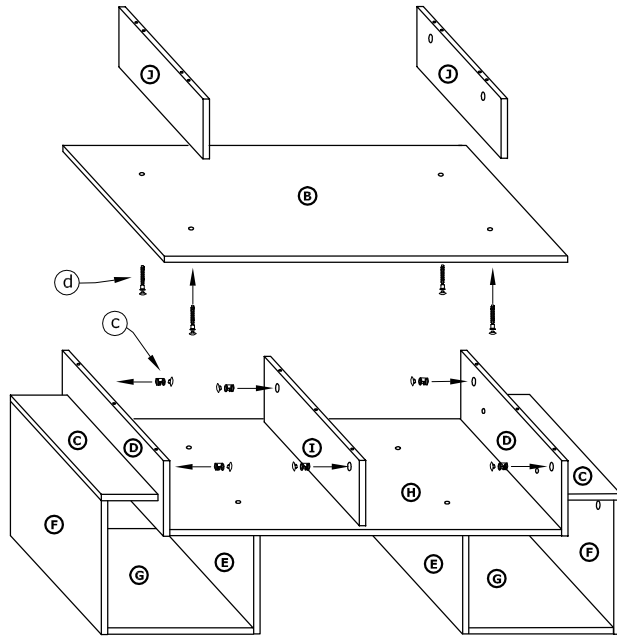

6

x 4	
(c)	

