

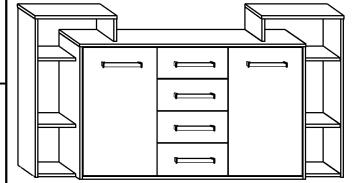

RIO-06

KOMODA 2D4S

→ 165 + 86 \ 41



x 16 a	x 32 b	x 32 c	x 36 d	x 10 e	x 8 f		
x 4 g	x 4 h	x 56 (3,5x16) i	x 16 (3,5x30) j	x 16 k	x 120 l		x 1 m
x 6 n	x 4 kpl. (350 mm) o						

1 - FAZY MONTAŻU

A - OZNACZENIE ELEMENTÓW

a - OZNACZENIE AKCESORIÓW



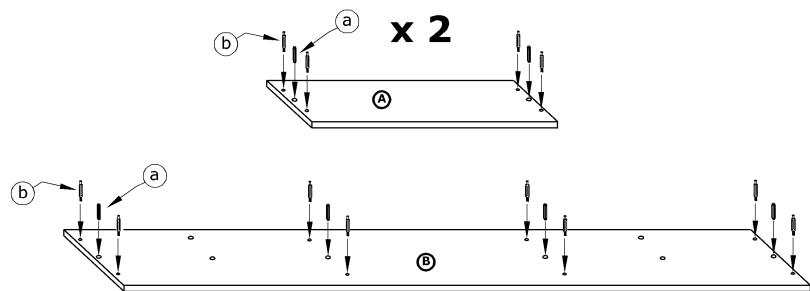
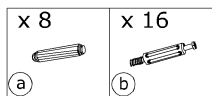

1

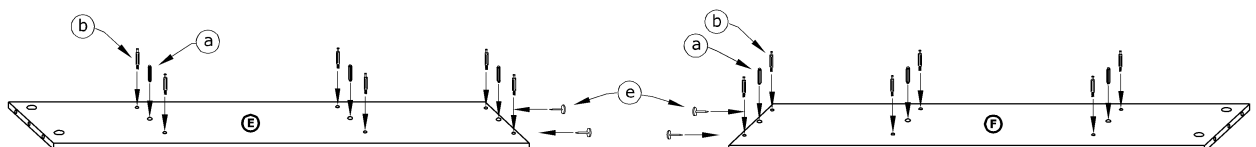
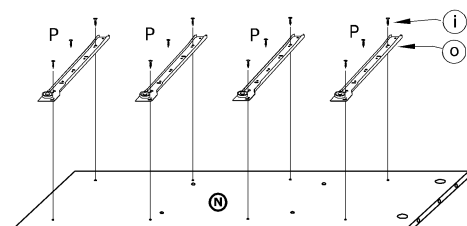
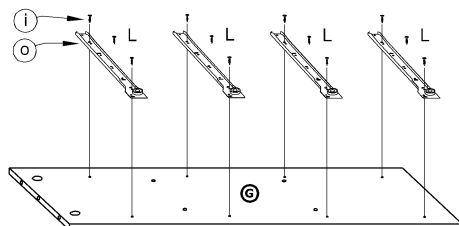
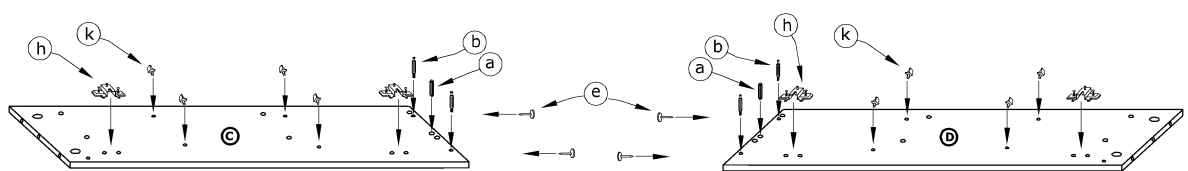
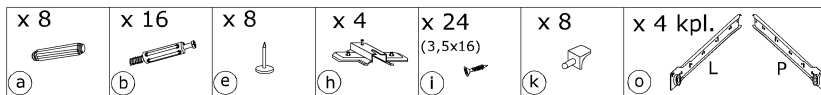

2



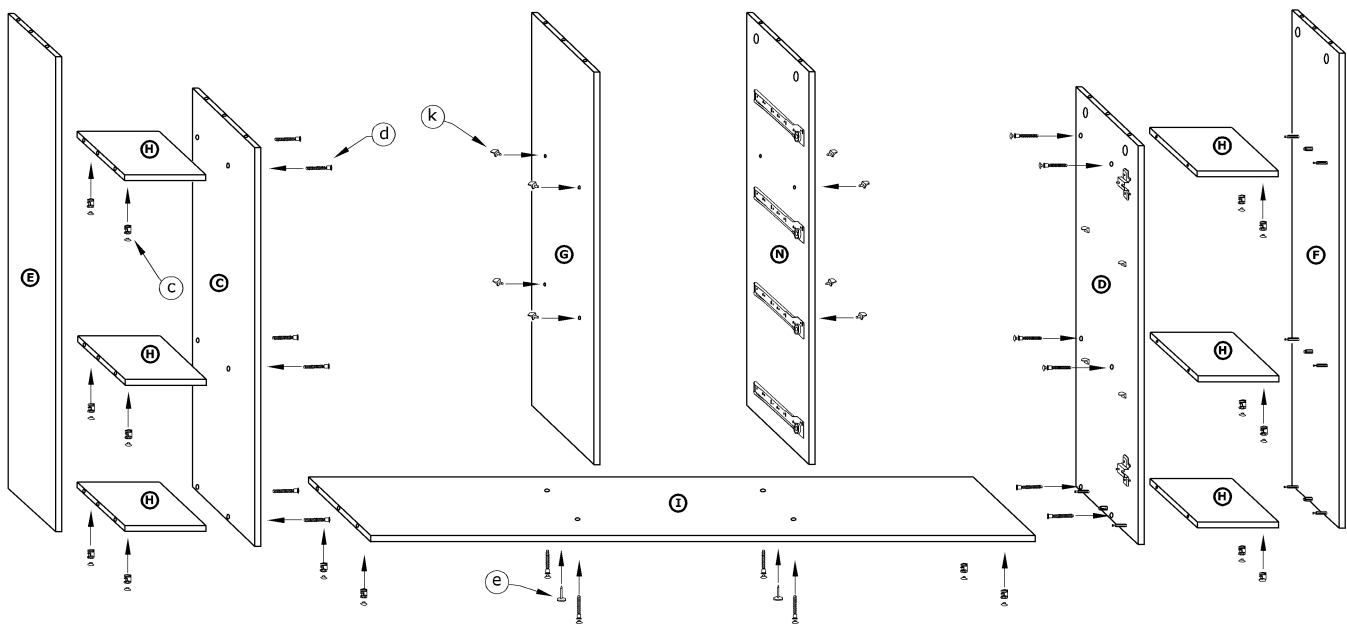

3

- | | | | |
|-----------------------------------------------------------------------------------|-----------------------------------------------------------------------------------|-----------------------------------------------------------------------------------|-----------------------------------------------------------------------------------|
| x 16 | x 16 | x 2 | x 8 |
|  |  |  |  |
| (c) | (d) | (e) | (k) |



4

- | | |
|-------------------------------------------------------------------------------------|-------------------------------------------------------------------------------------|
| x 16 | x 4 |
|  |  |
| (c) | (d) |

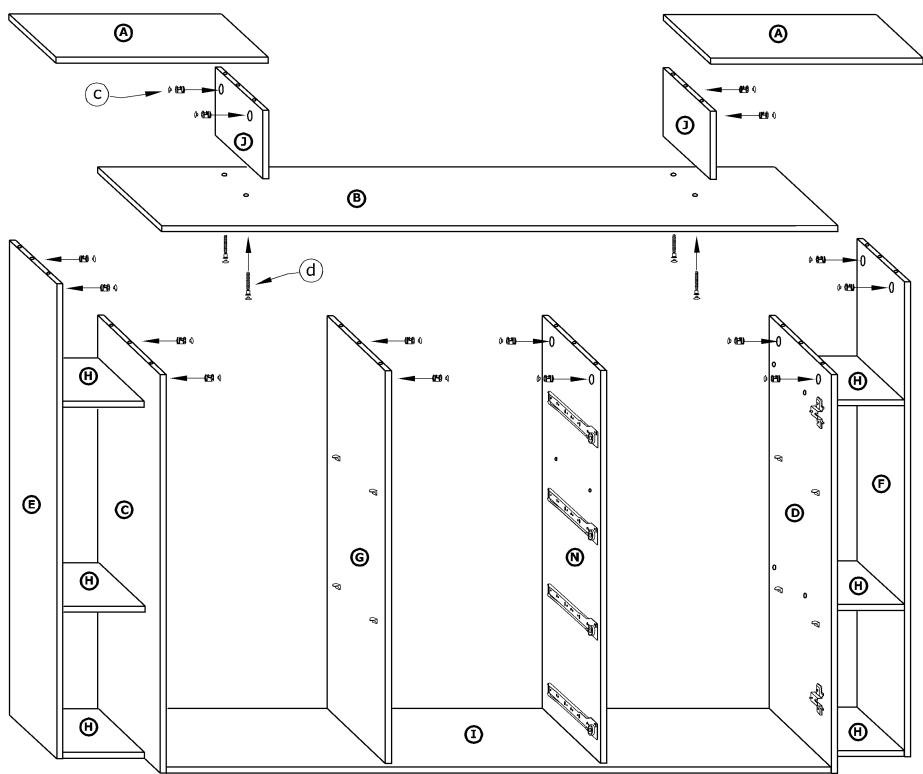

5

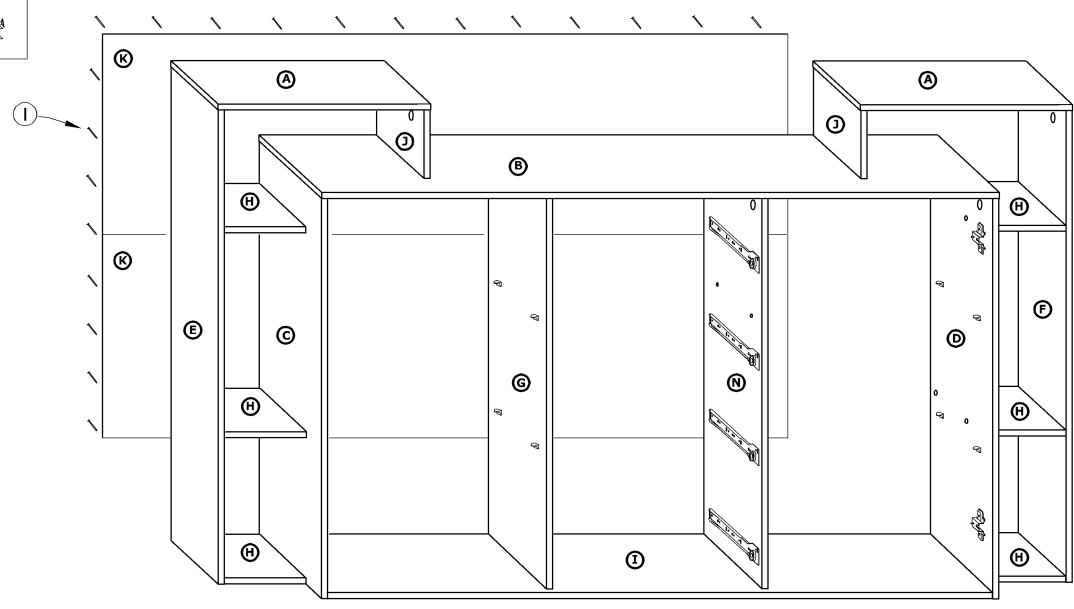
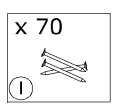

6

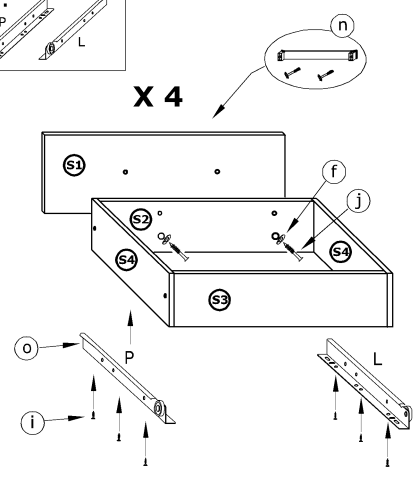
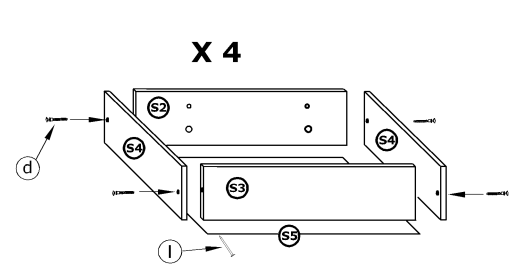
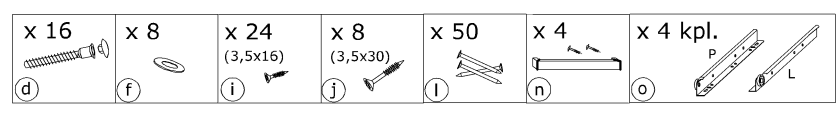

7

