

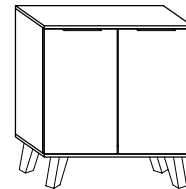

SVN-01 KOMODA 2D

→ 80 ↑ 89 ↘ 40



x 2 a	x 4 b	x 4 c	x 12 d	x 4 e	x 4 f	
x 4 g	x 4 (3x16) h	x 8 (3,5x16) i	x 40 j	x 2 k	x 1 l	
x 4 m					 60 min 	



1 - FAZY MONTAŻU

A - OZNACZENIE ELEMENTÓW

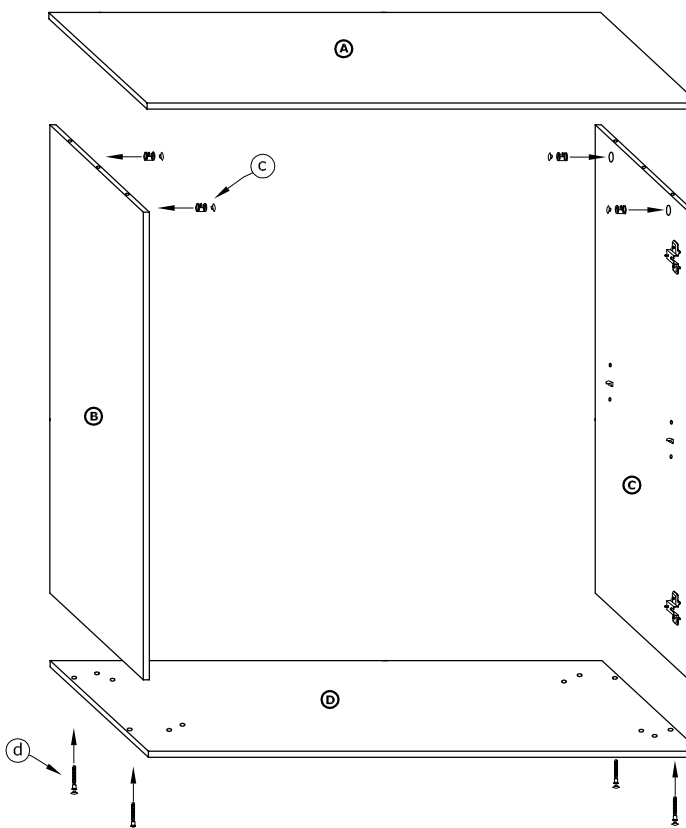
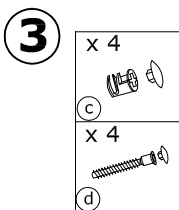
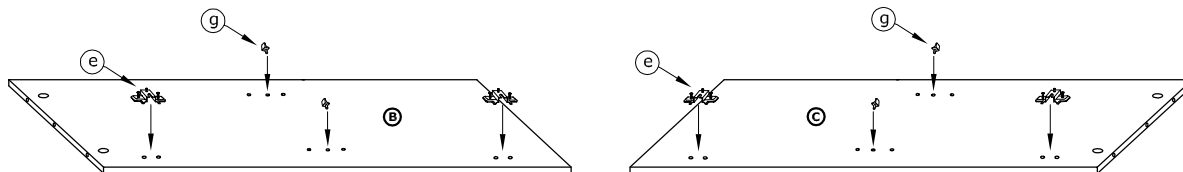
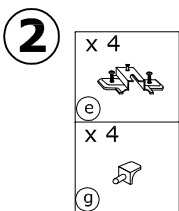
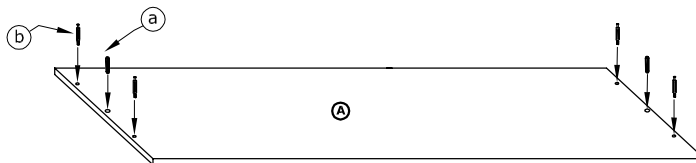
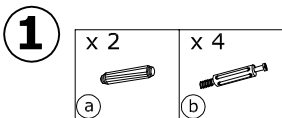
a - OZNACZENIE AKCESORIÓW



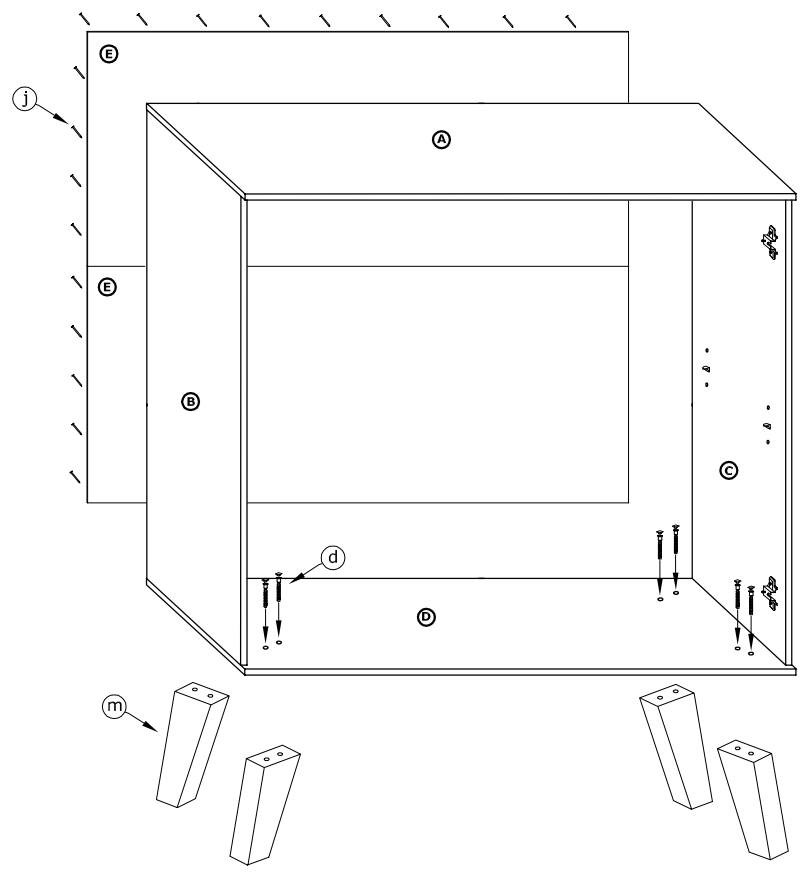

4

- x 2 
- x 40 
- x 4 



5

- x 4 
- x 4 (3x16) 
- x 8 (3,5x16) 
- x 2 