

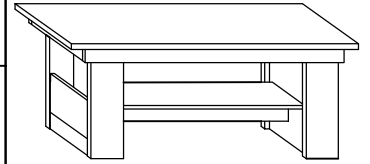

MXS-16 ŁAWA → 125 × 53 × 68



x 8



x 53



x 53



x 10

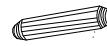

(a)

(b)

(c)

(d)

x 4



x 2



x 4

(3,5x16)



x 1

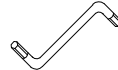

(e)

(f)

(g)

(h)

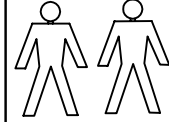

40 min

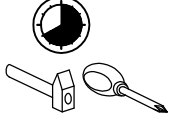
**1** - FAZY MONTAŻU**A** - OZNACZENIE ELEMENTÓW**a** - OZNACZENIE AKCESORIÓW**1**

x 1

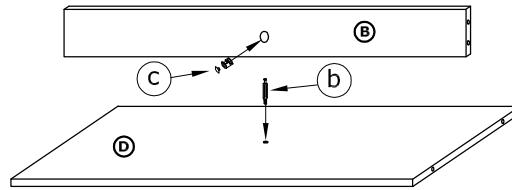

x 1

**2**

x 8



x 8

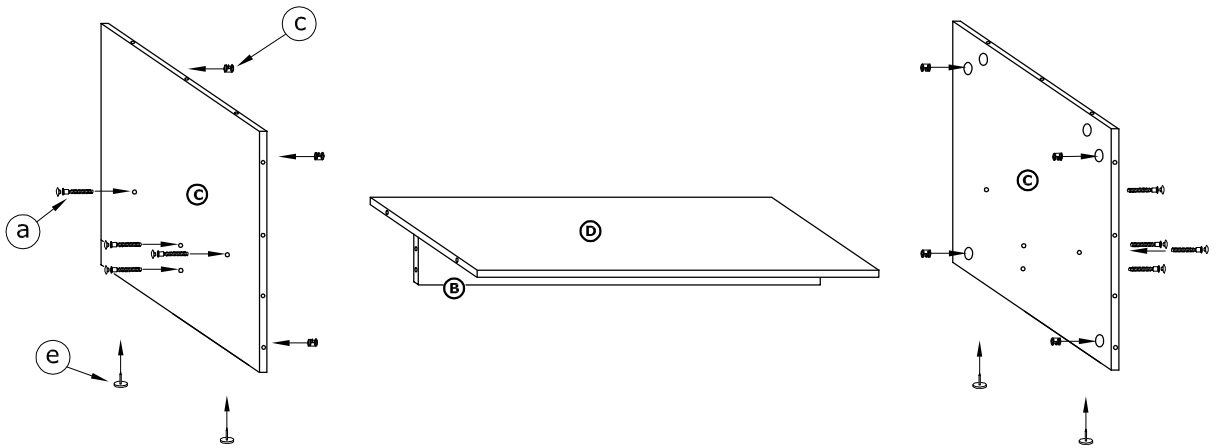

x 4

**3**

x 14



x 4

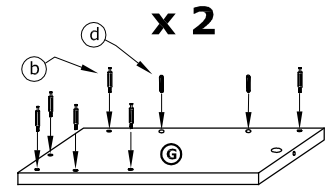
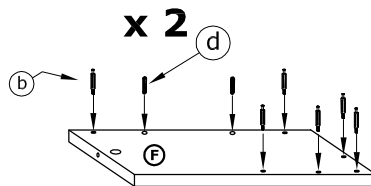
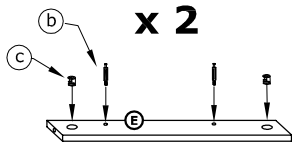

x 8

**4**

x 8

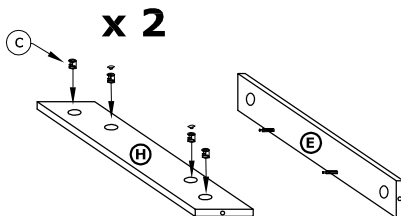
**5**

x 8

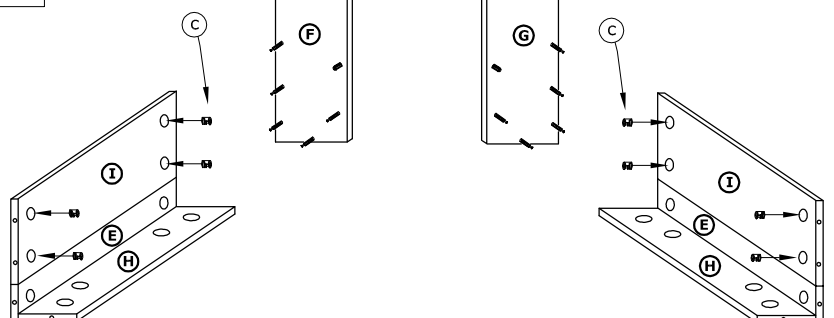

6

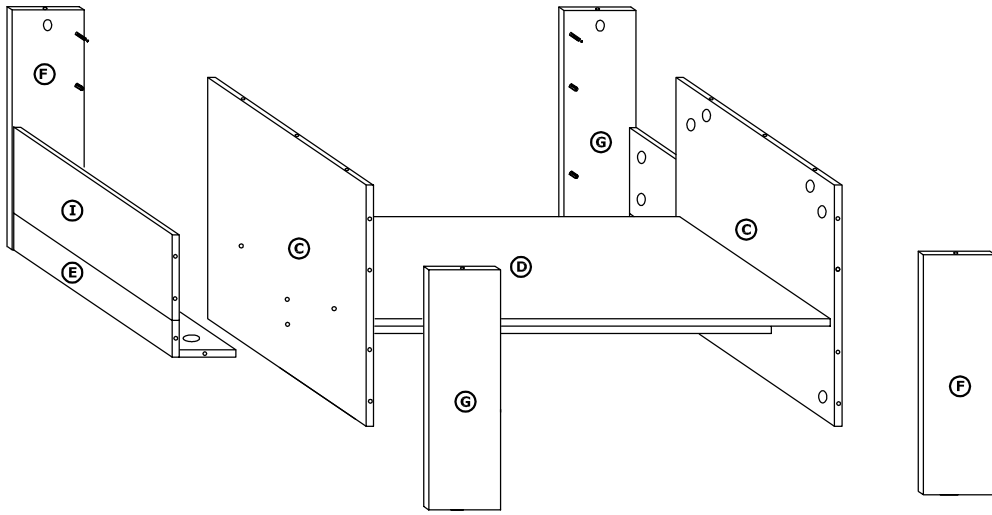

7

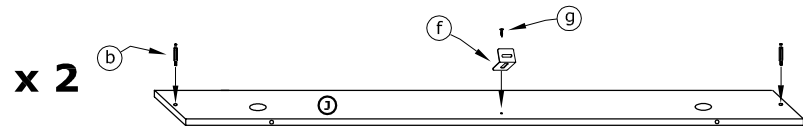
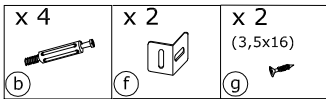

8

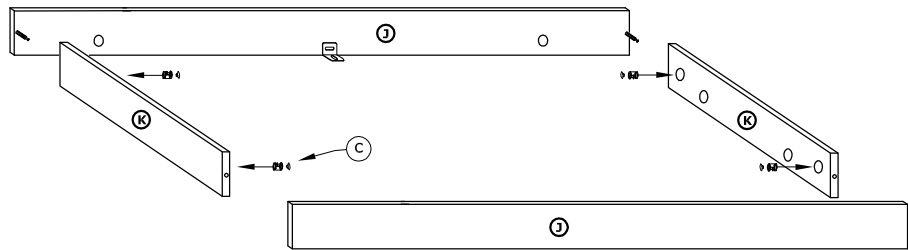
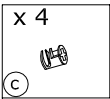

9

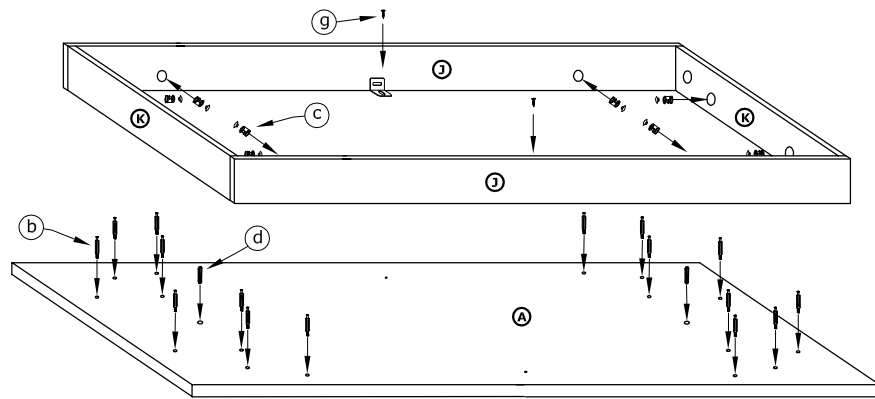
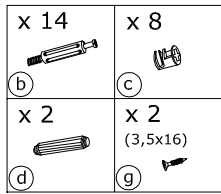

10

