

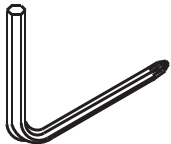

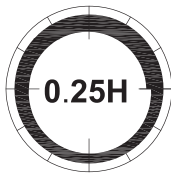

ALPHA

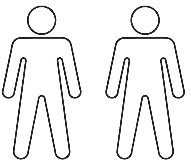
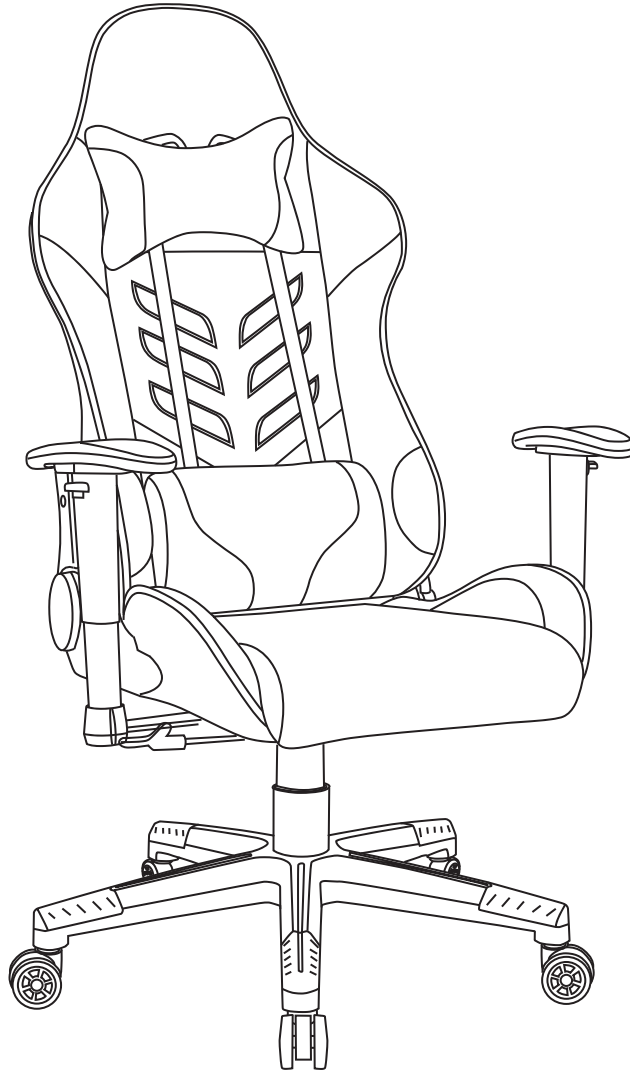
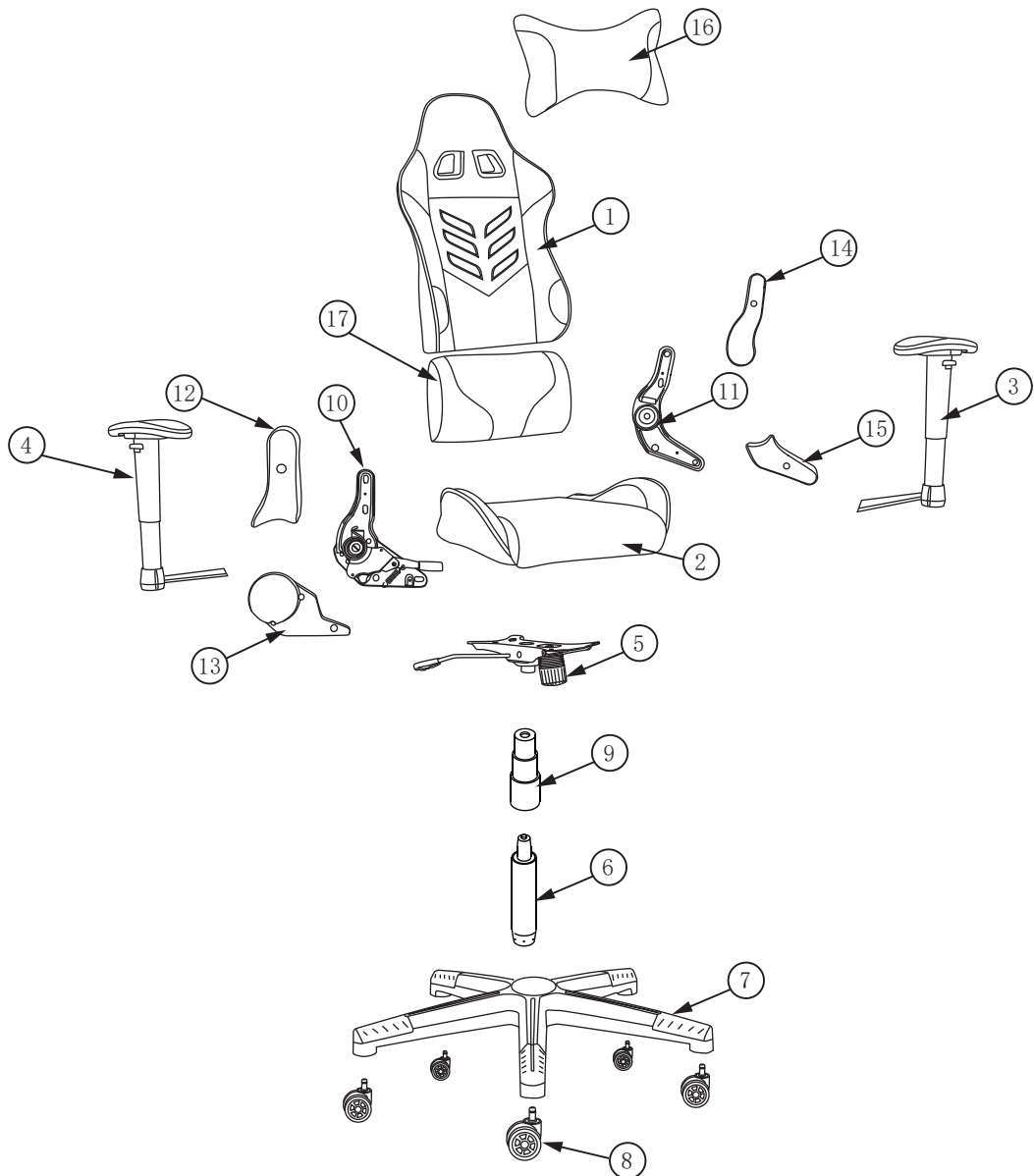

			✓
①	1	840x530x170	
②	1	540x530x160	
③	1	270x280x230	
④	1	270x280x230	
⑤	1	70x280x175	
⑥	1	Φ50x280	
⑦	1	Φ700x90	
⑧	5	Φ60	
⑨	1	290x75	
⑩	1	295x225x35	

			✓
⑪	1	210x300x25	
⑫	1	180x80x30	
⑭	1	75x250x20	
⑬	1	115x245x45	
⑮	1	90x200x20	
⑯	1	300x280x90	
⑰	1	310x190x80	



<p>A x 16</p>  <p>M8 x 25 mm</p>	<p>B x 6</p>  <p>M5 x 10 mm</p>	<p>C x 1</p>  <p>6 mm</p>	<p>D x 8</p>  <p>Φ18 x Φ8 x 1.2mm</p>	
---	--	--	--	--

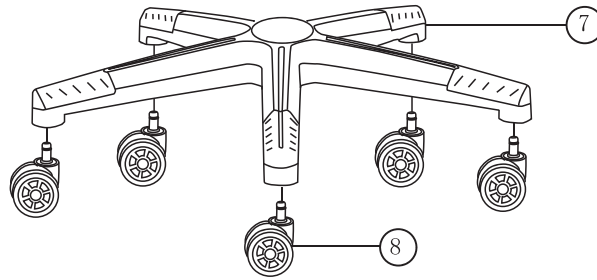

1

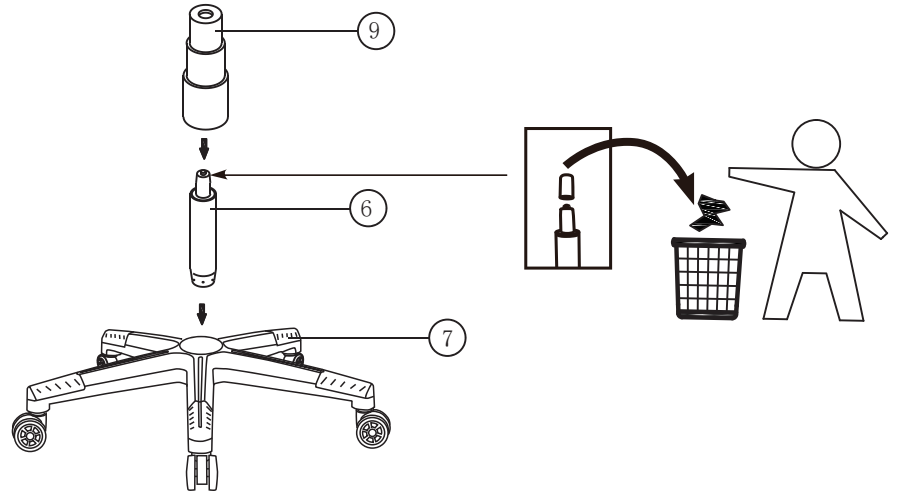

2



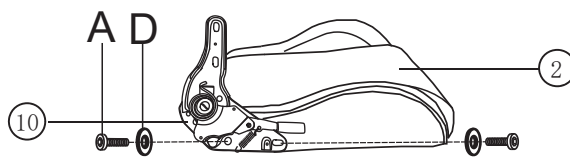

3

A x 2	D x 2
	
M8 x 25 mm	Φ18 x Φ8 x 1.2mm



4

A x 2  M8 x 25 mm	D x 2  Φ18 x Φ8 x 1.2mm
--	--

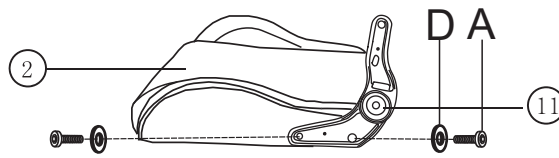

5

A x 4  M8 x 25 mm
--

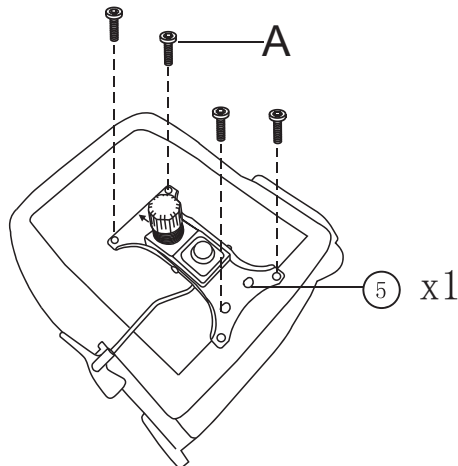
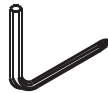

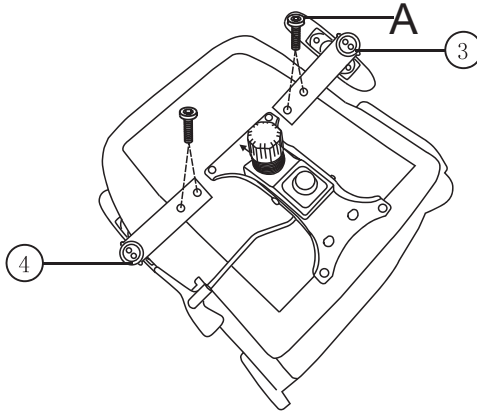
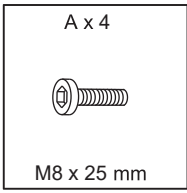

6

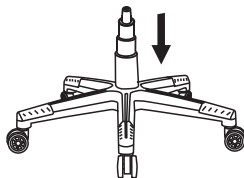
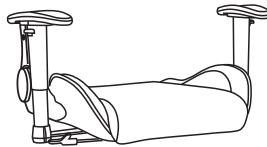

7



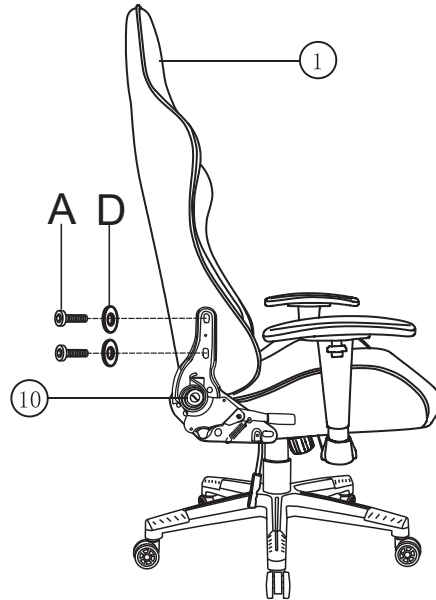

8

A x 2	D x 2
	
M8 x 25 mm	Φ18 x Φ8 x 1.2mm



9

A x 2	D x 2
	
M8 x 25 mm	Φ18 x Φ8 x 1.2mm

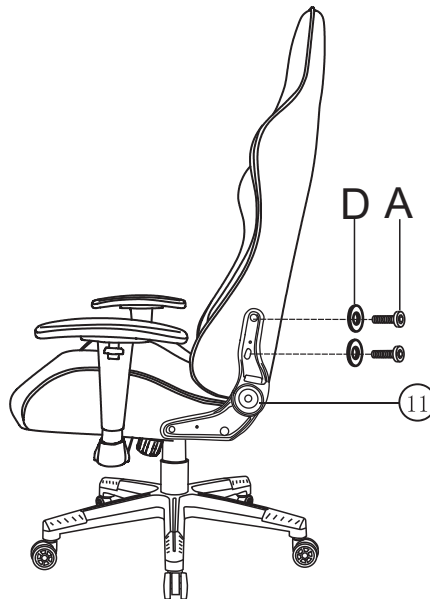

10

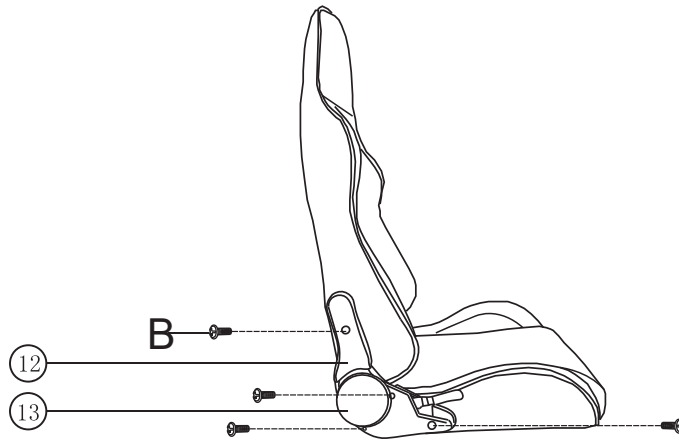
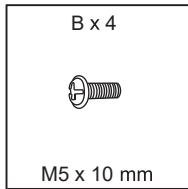

11

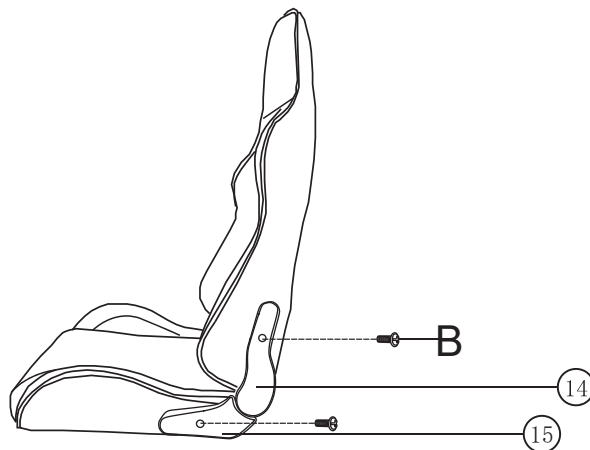
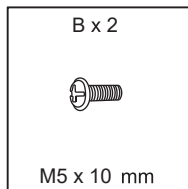

12

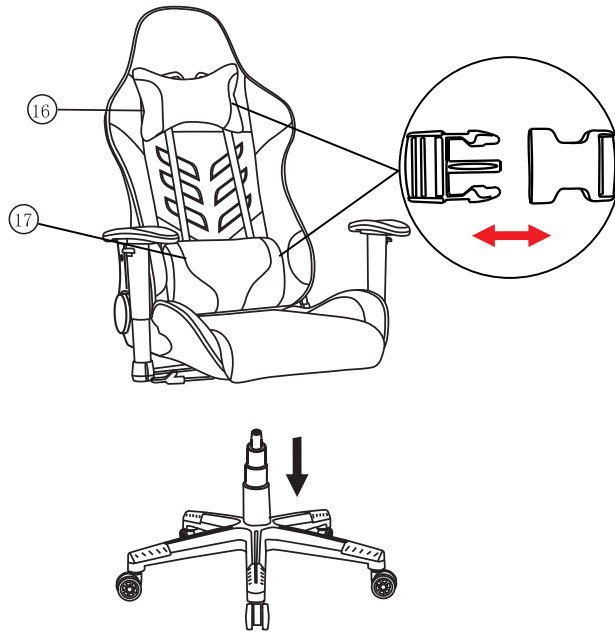

13

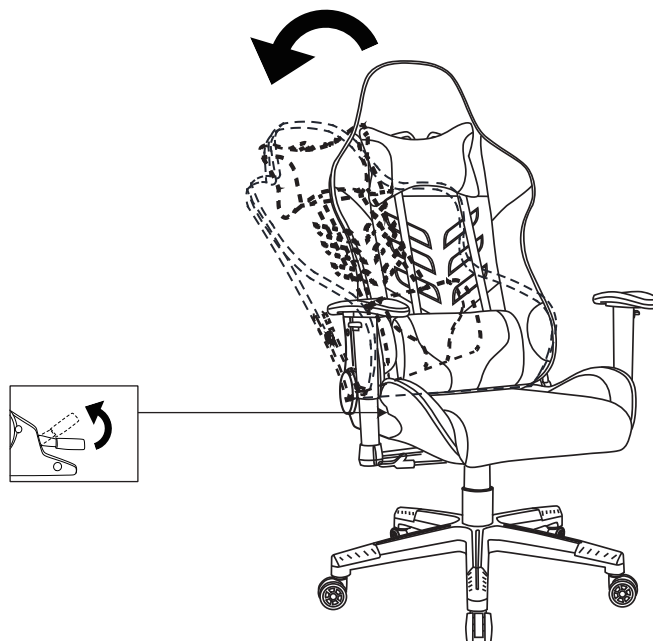

14



15

