

PHILOSOPHY PH-14

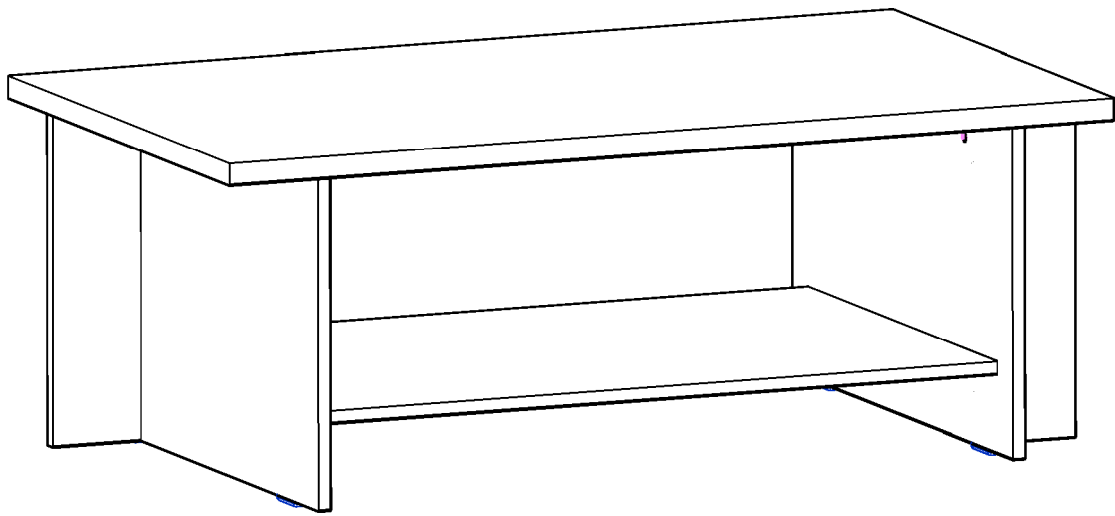

Company: "DIG-NET" LENART Sp. j
63-611 Mroczeń 65a
e-mail: dignet@home.pl

Potrzebne narzędzia / Benötigttes Werkzeug / Required tools / Potřebné nástroje / Potrebné nástroje / Необходимые инструменты

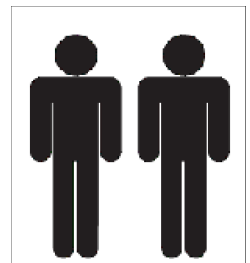

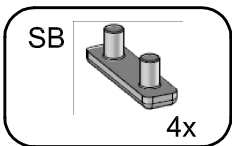
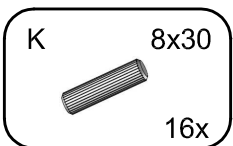
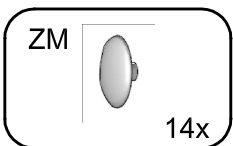
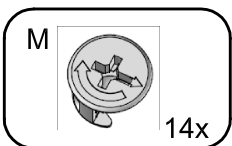
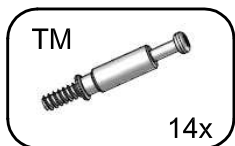
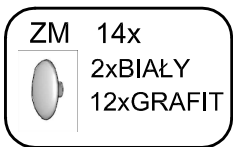
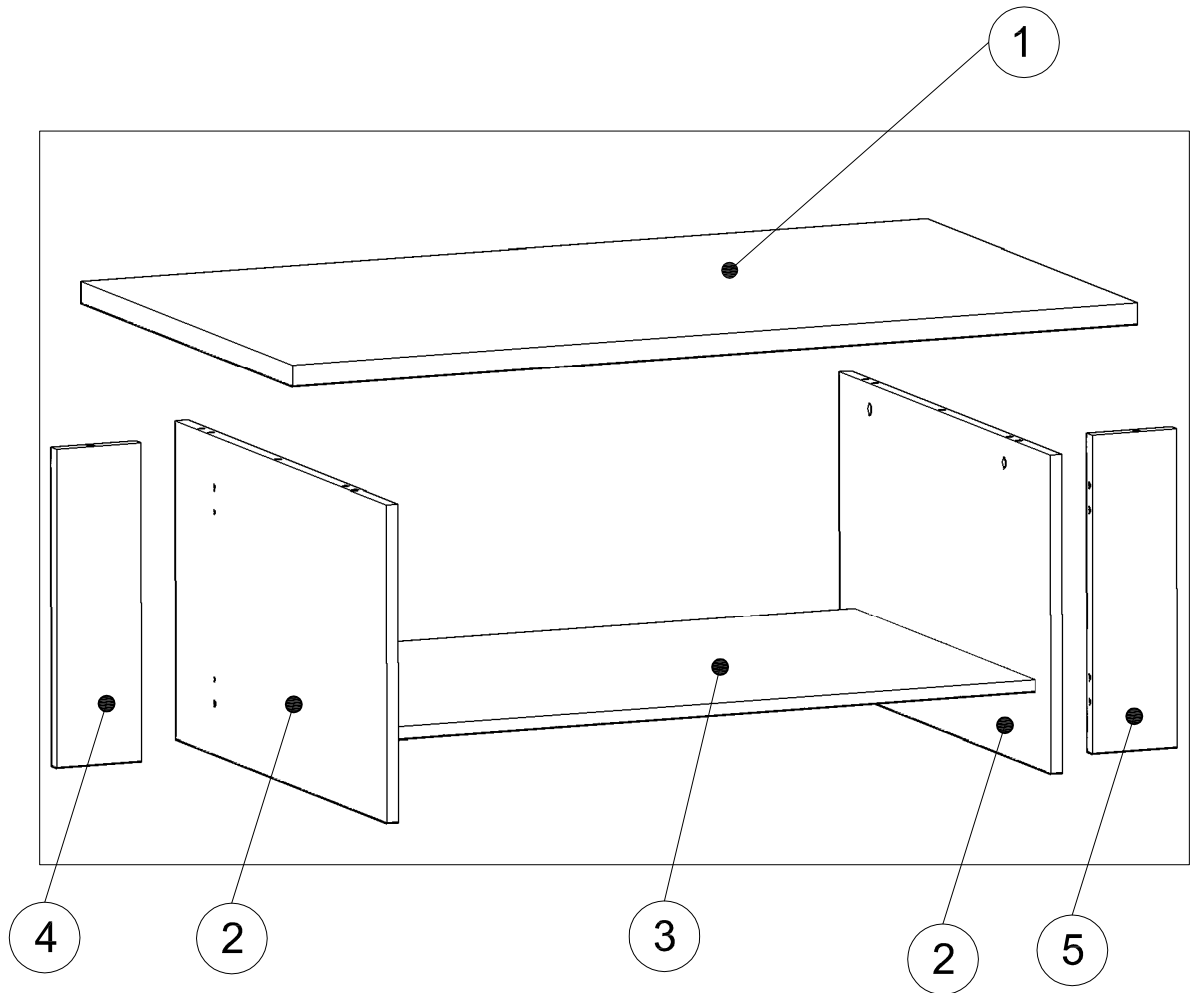
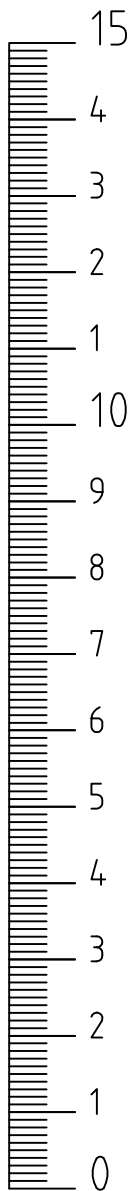

Proszę sprawdzić kompletność okuć przed montażem
 Bitte überprüfen Sie die Vollständigkeit der Fittings vor der Montage
 Please check the completeness of the fittings before assembly

Prosím zkontrolujte úplnost konektorů před instalací
 Prosím skontrolujte úplnosť konektorov pred inštaláciou
 Пожалуйста, проверьте комплектность фурнитуры перед установкой

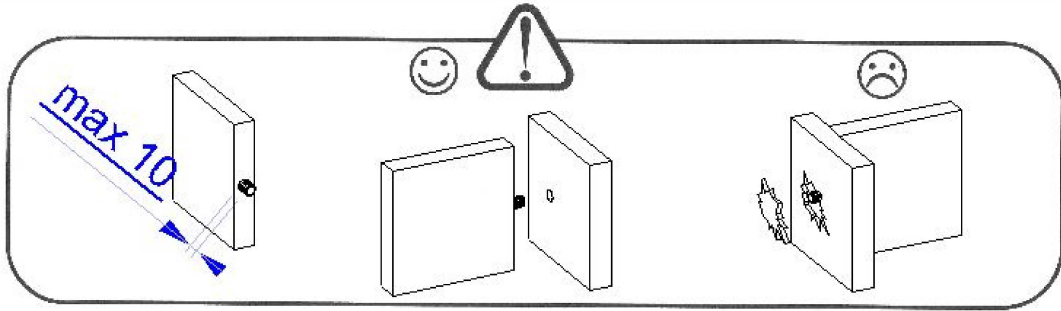
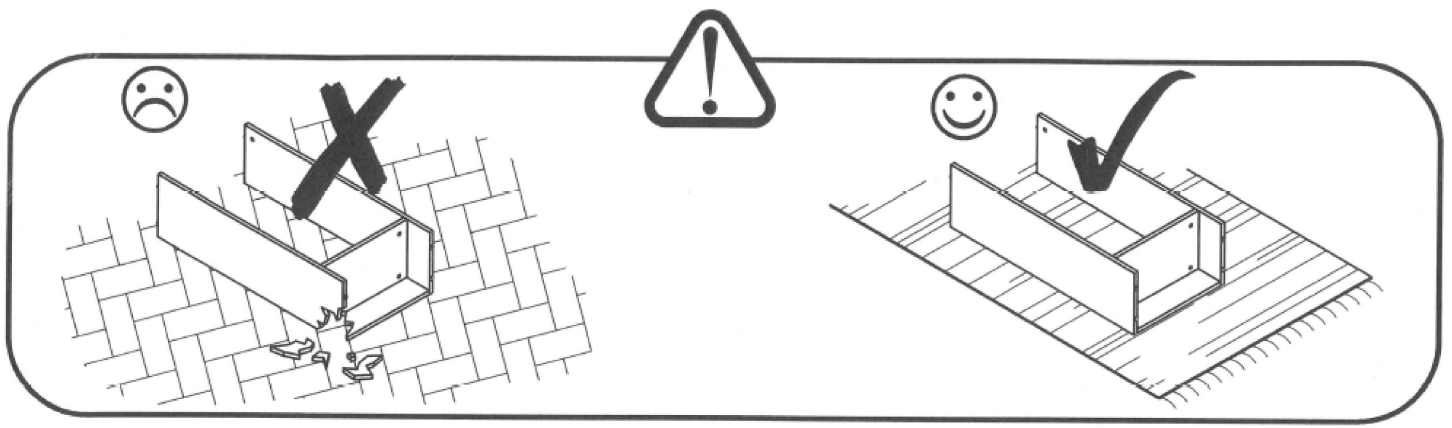

1

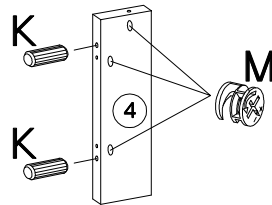
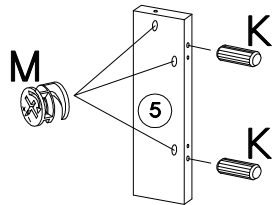
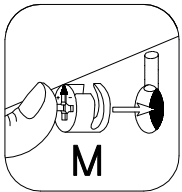
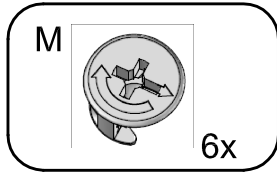
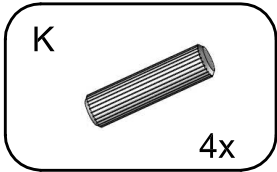

2

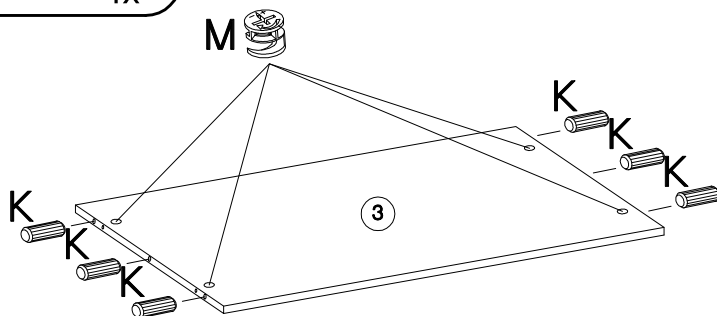
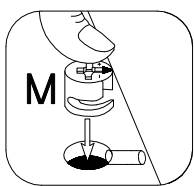
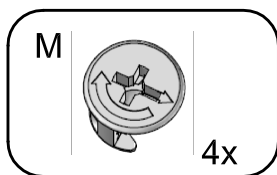
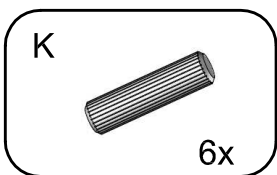

3

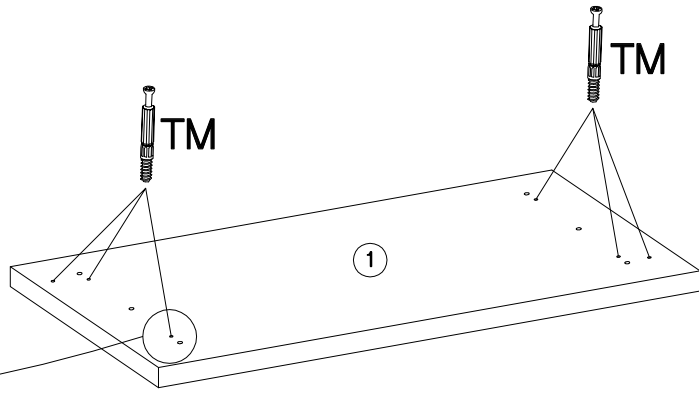
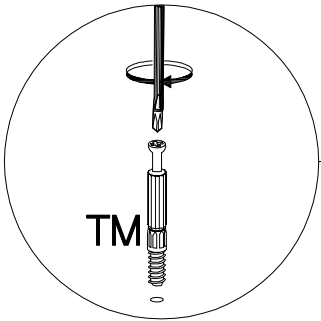
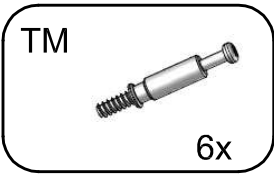

4

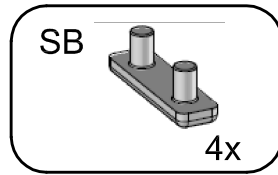
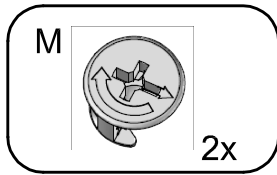
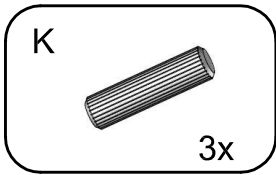
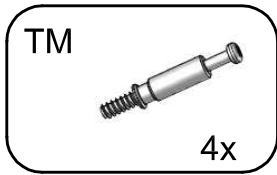

2x

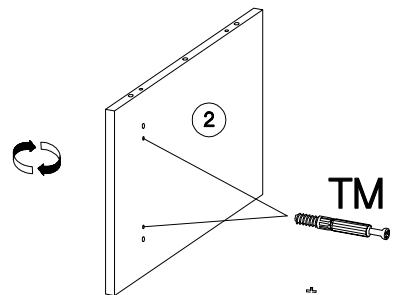
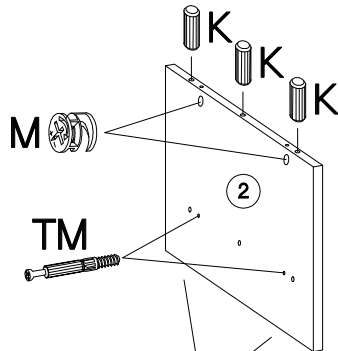
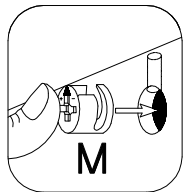
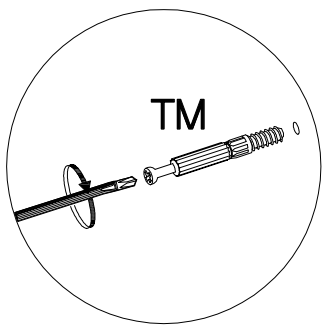

5

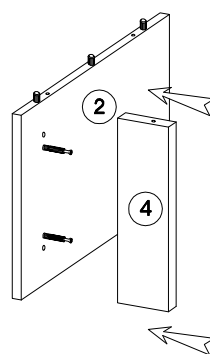
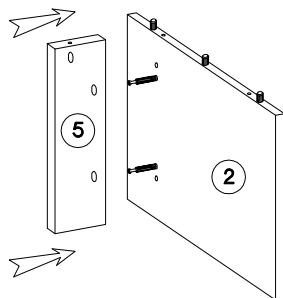
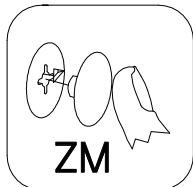
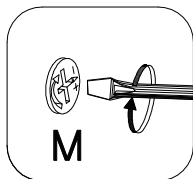
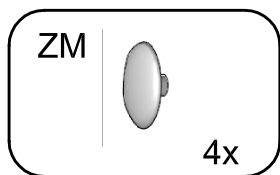

6

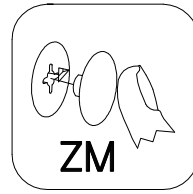
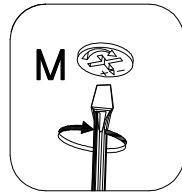
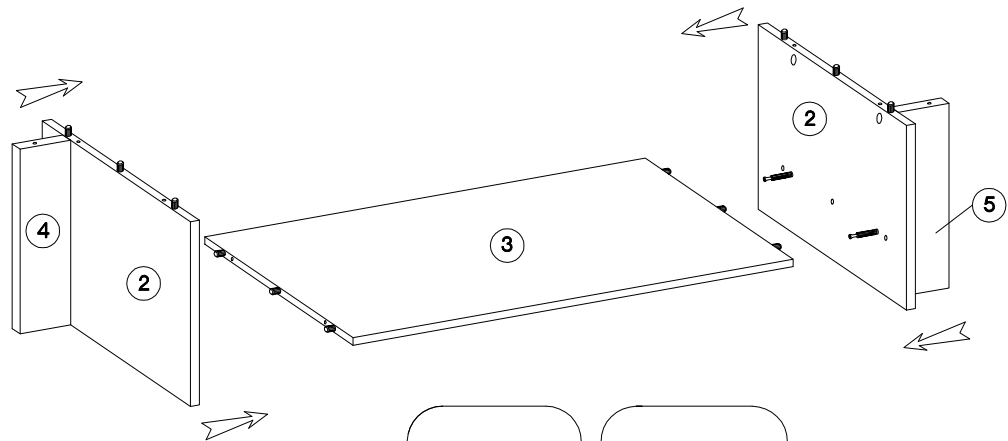
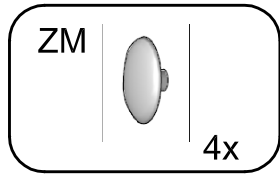

7

