

Function

33-250

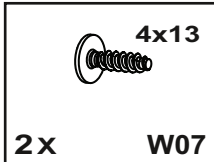
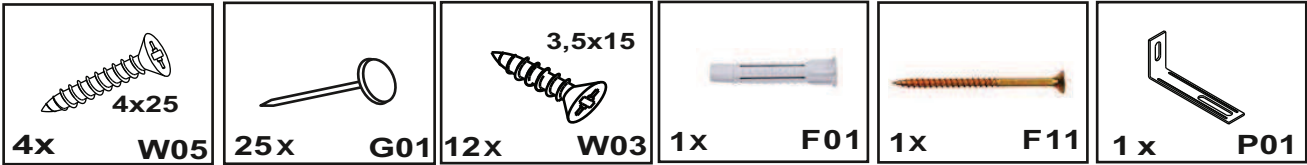
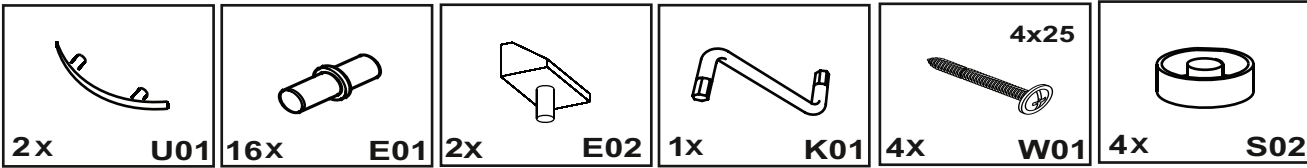
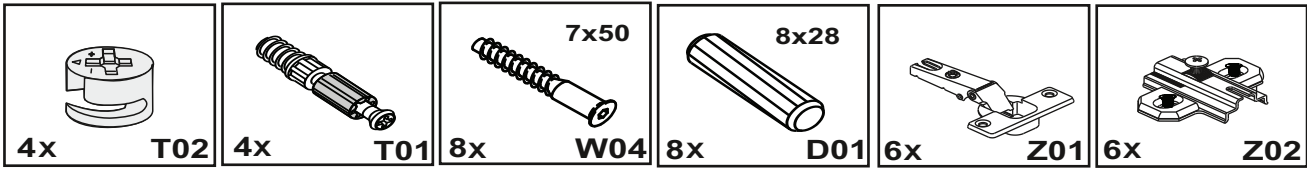
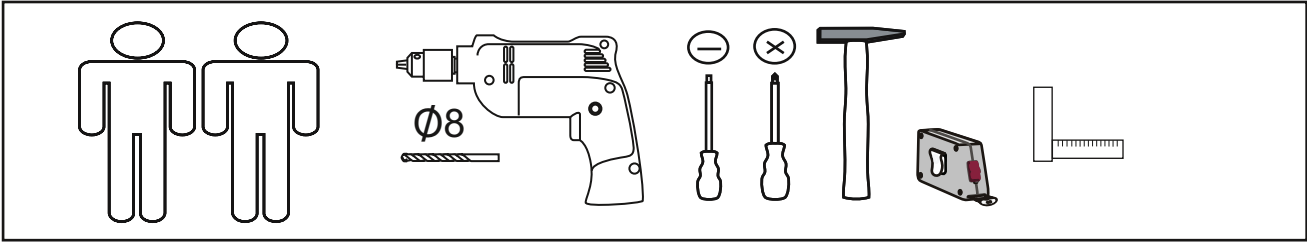

Nr	Ausmaß		St	Colli	
1	1707	320	15	1	2
2	1707	320	15	1	2
3	661	280	15	1	1
4	692	340	18	1	2
5	692	340	15	1	2
6	661	280	15	4	1
7	1726	680	2	1	2
8	1701	342	15	2	1

1

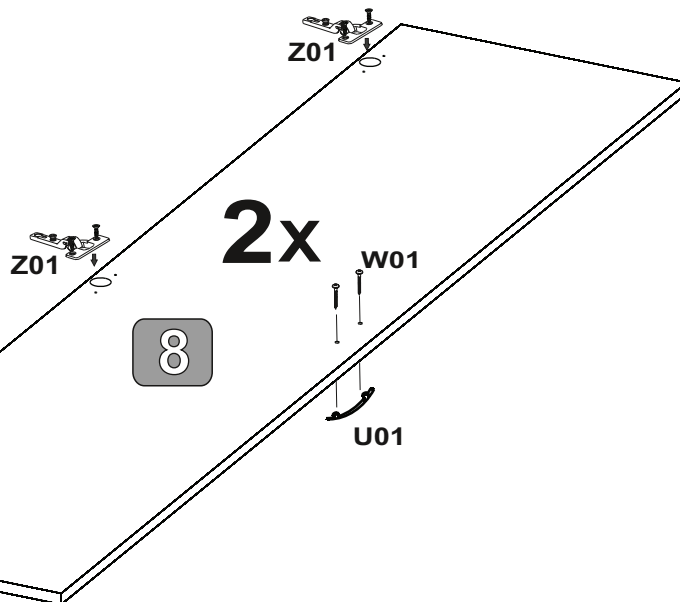
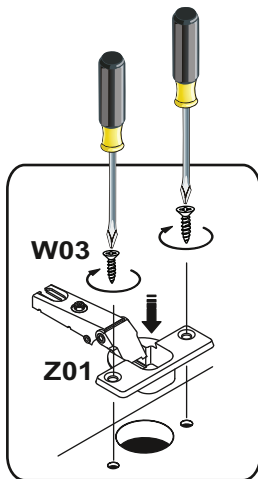
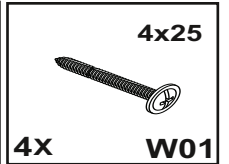
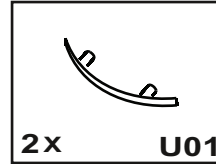
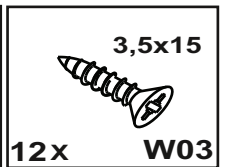
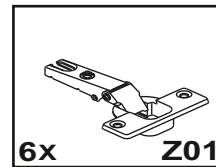
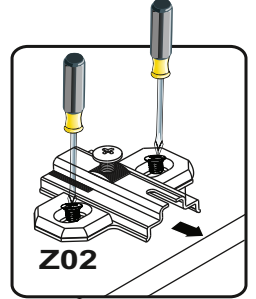
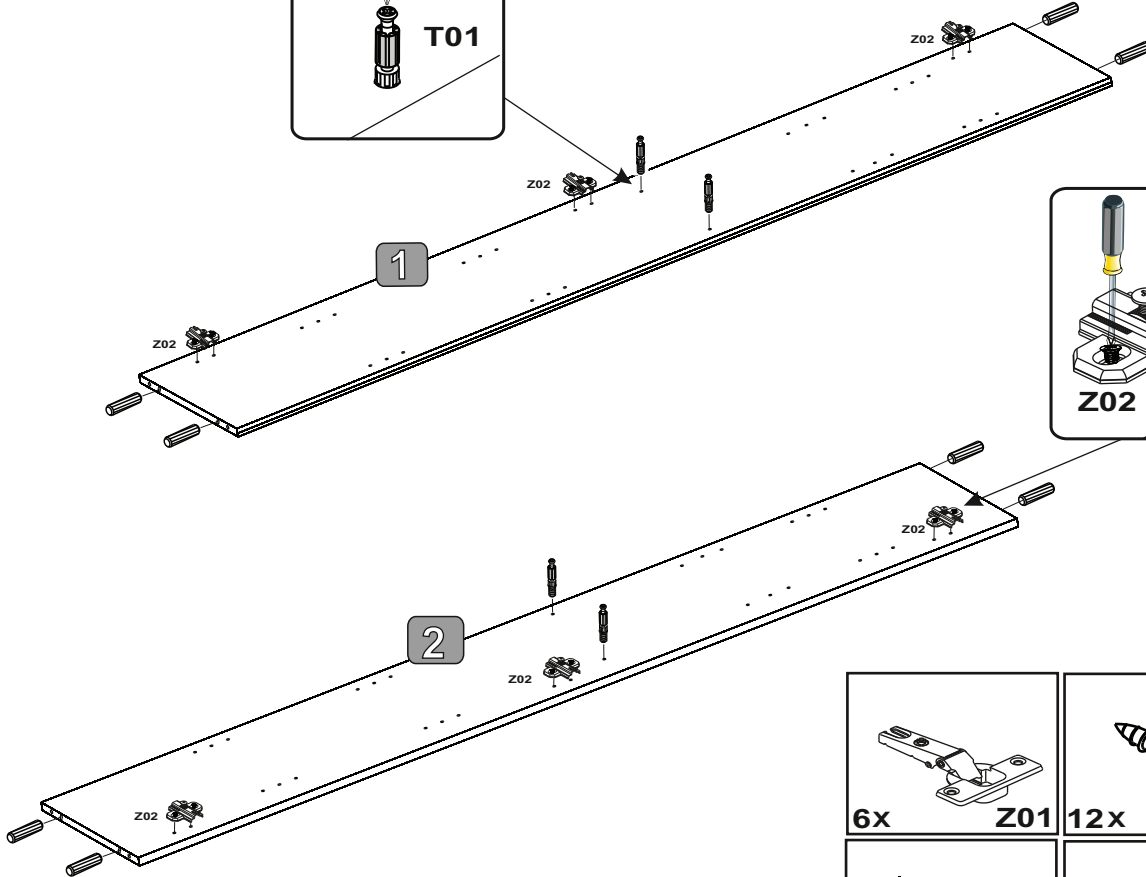
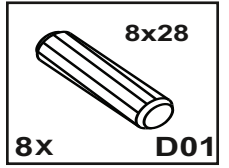
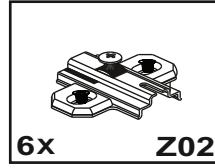
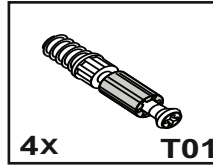
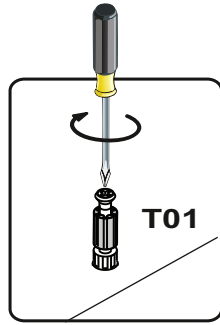

2

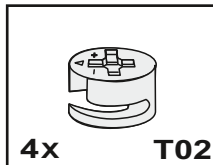
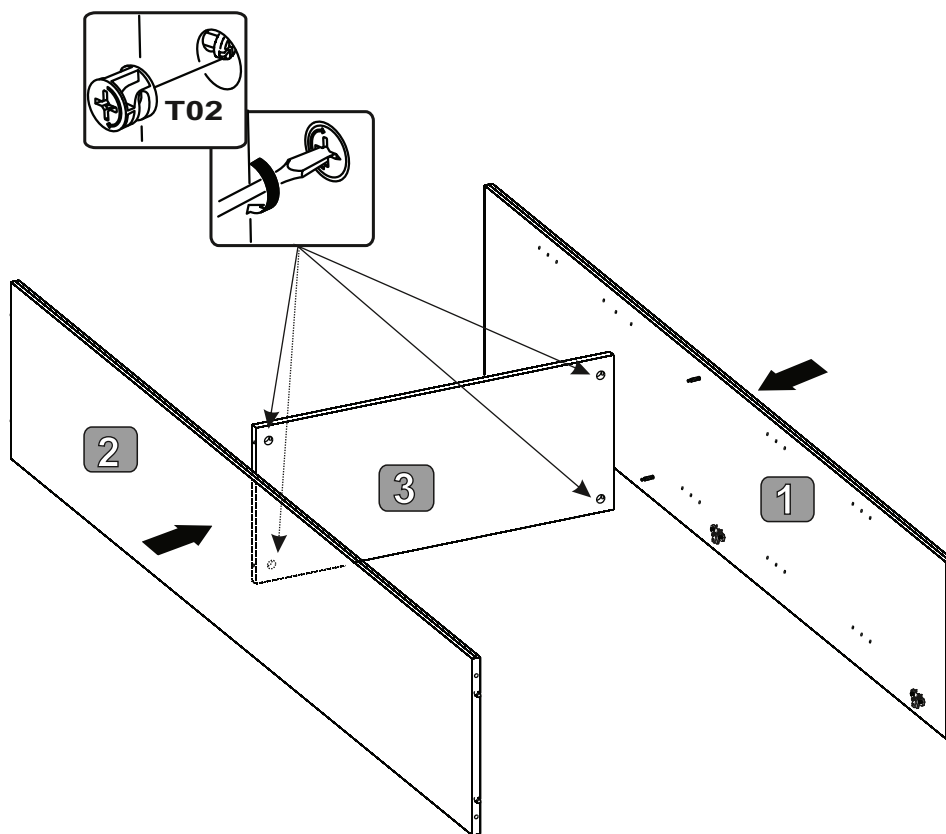

3

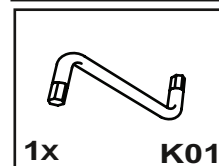
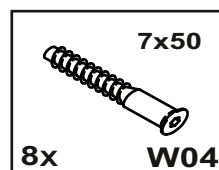
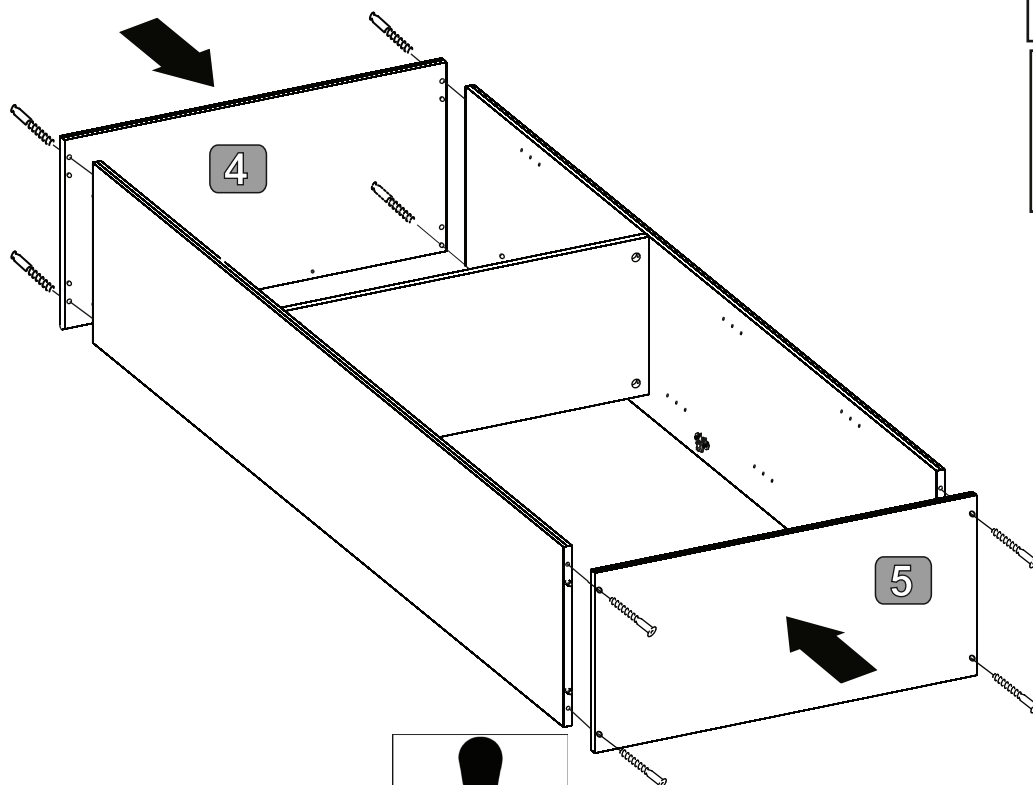

Let op!

Bovenkant plank nr. 4 = 18 mm

Onderkant plank nr. 5 = 15 mm

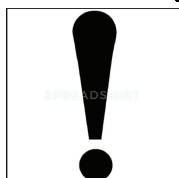

4

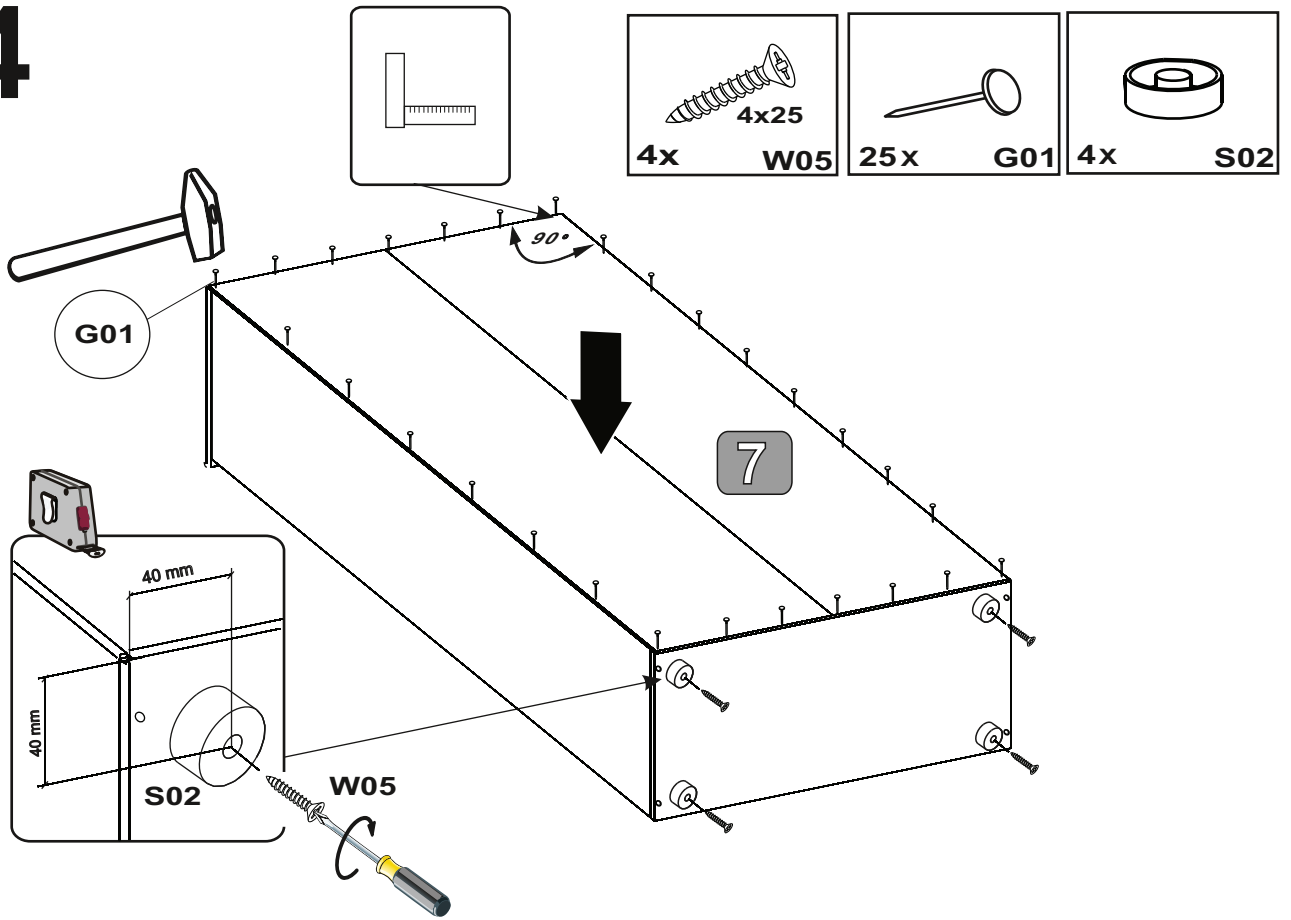

5

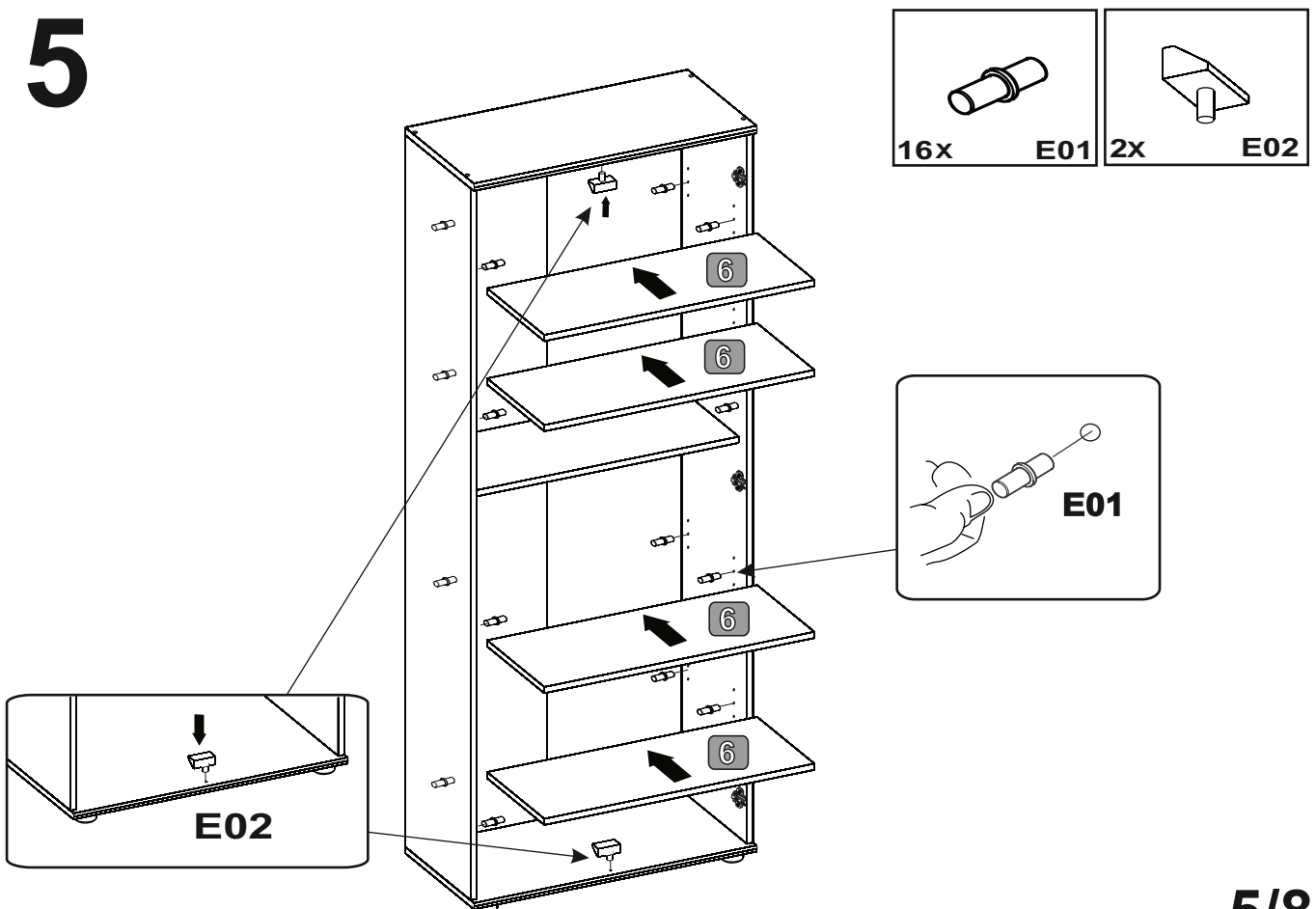

6



1 x

P01

1 x

F11

1 x

F01

2 x

W07

