

# Montageanleitung

Notice de montage

Assembly instruction

**GERMANIA®**  
the furniture factory

## Garderobe 112

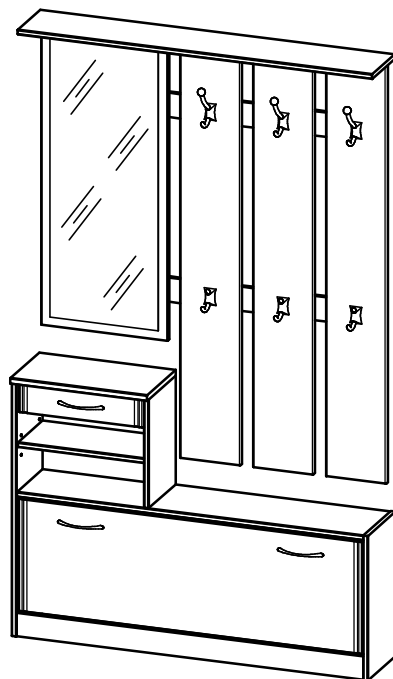

Dekor: 16, 24, 57,

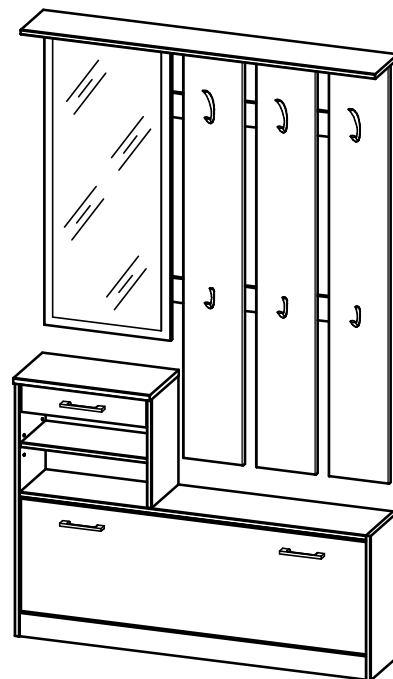

Dekor: 04,

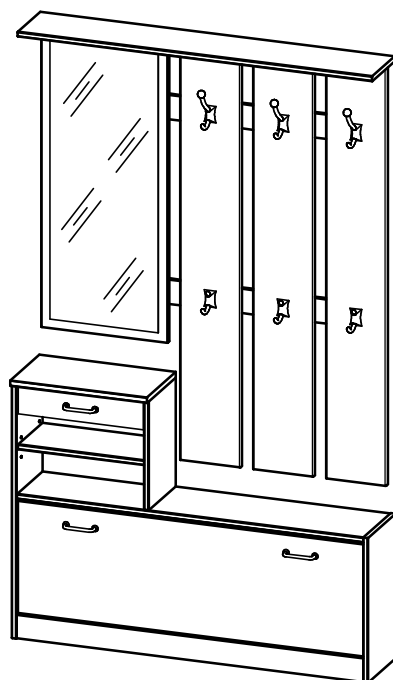

Dekor: 11, 12, 13, 19, 54,

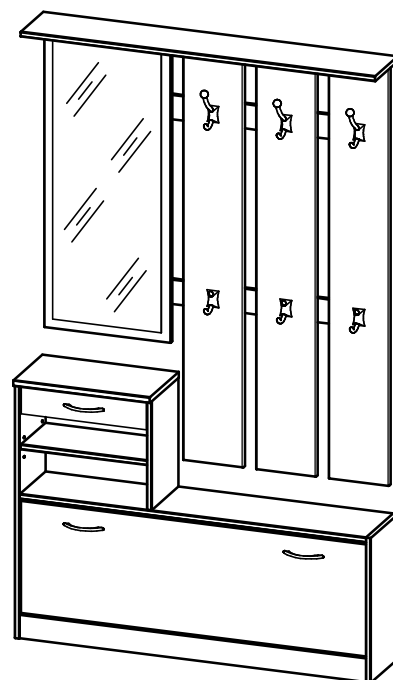

Dekor: 02,

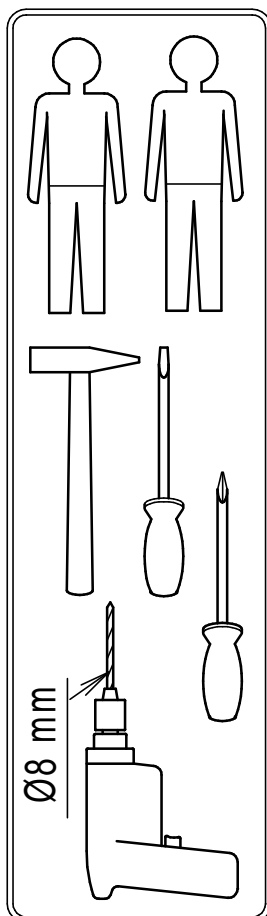

Bitte die Sicherheitshinweise auf der letzten Seite beachten!

Please note: safety instructions on the last page!

Prrière de suivre les instructions de sécurité figurant sur la dernière page!

erstellt		geändert		geprüft	
Datum: 12.10.05	Reimar	Datum: 31.07.07		Datum: 31.07.07	

Mod. 112 - **Teileliste** - liste de pièces - partlist

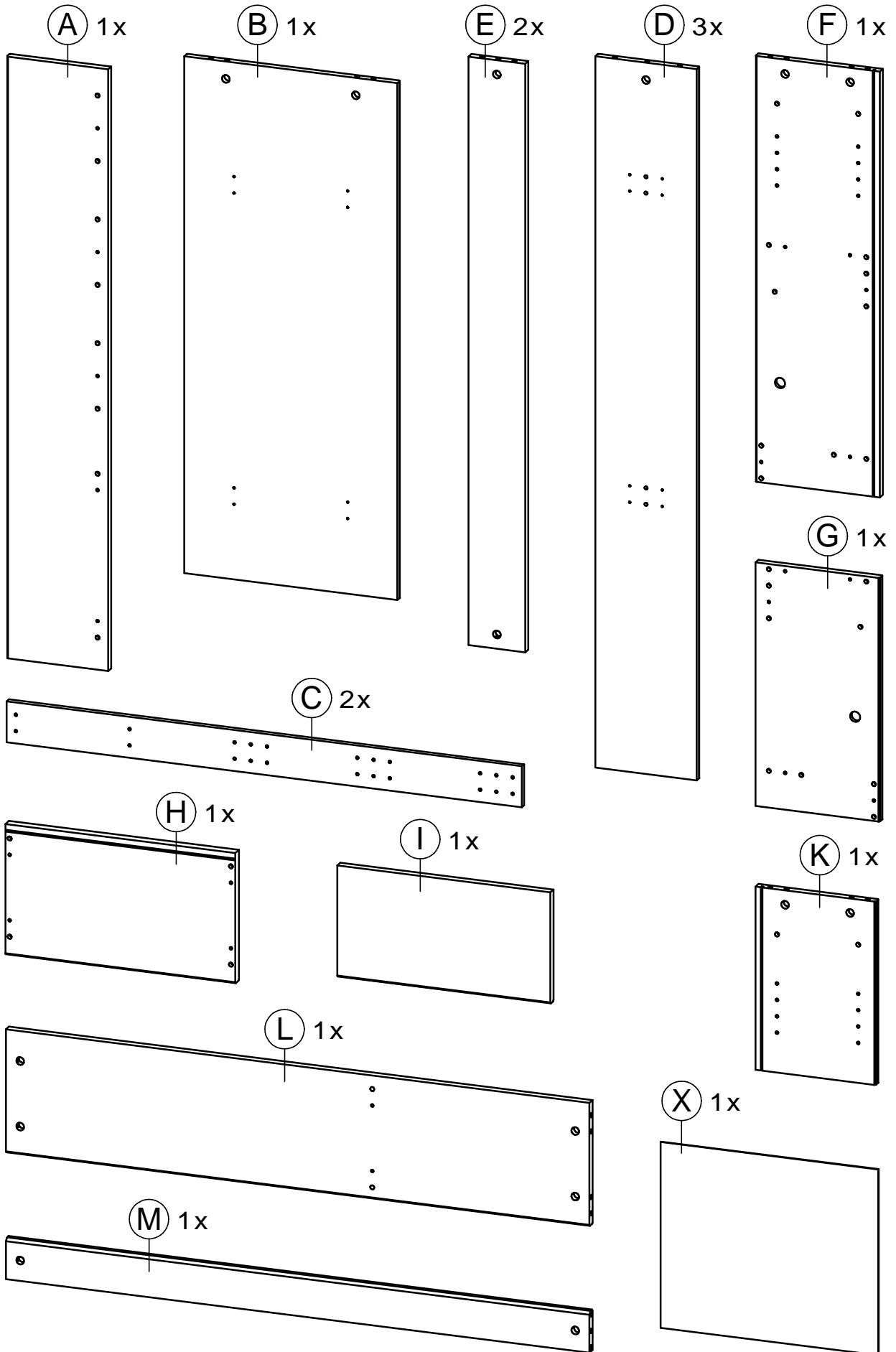

**2**

erstellt		geändert		geprüft	
Datum: 12.10.05	Reimar	Datum:		Datum:	

Mod. 112 - **Teileliste** - liste de pièces - partlist

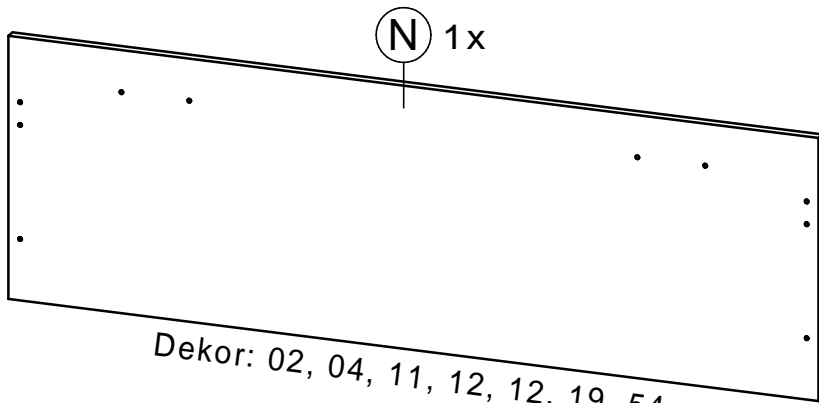

Dekor: 02, 04, 11, 12, 12, 19, 54,

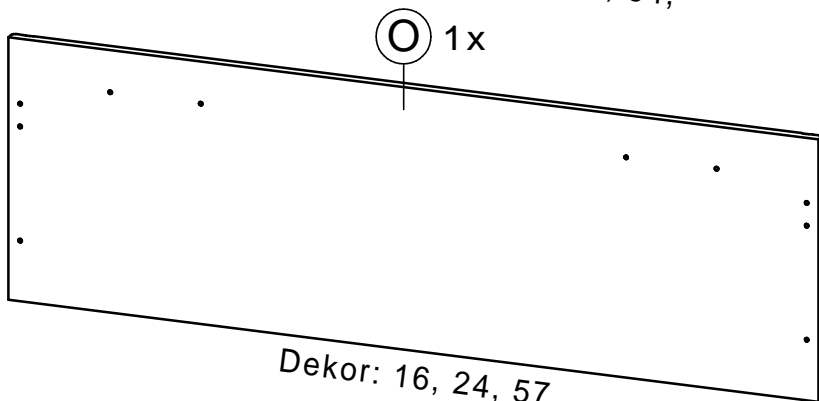
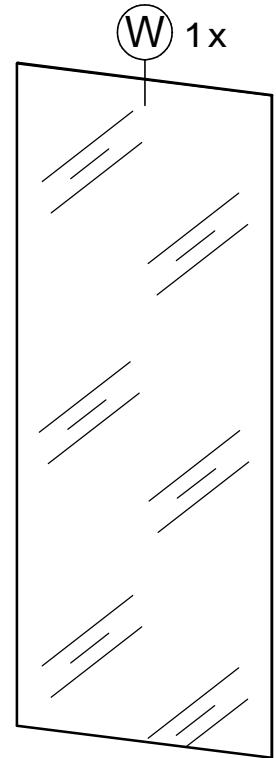



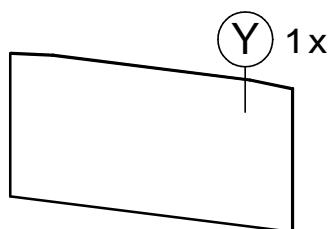
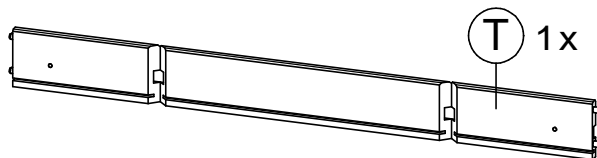
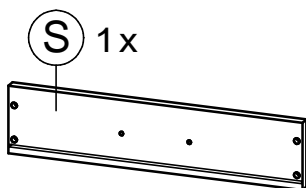
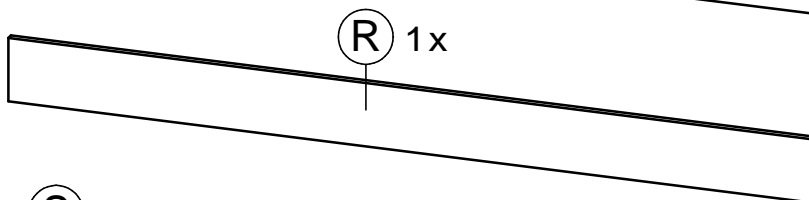
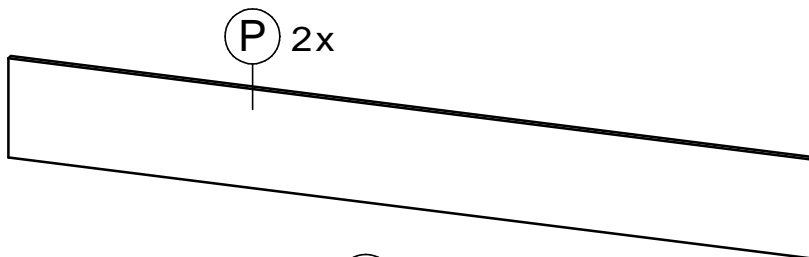









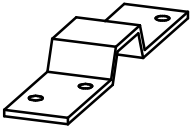
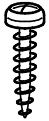

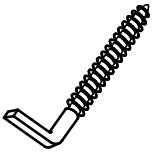
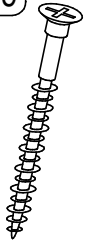
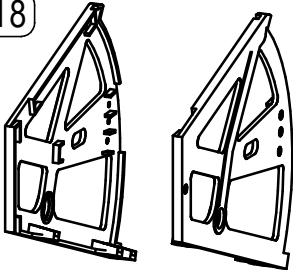
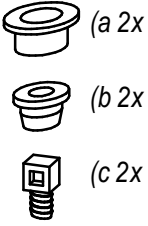

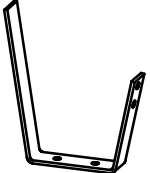
Dekor: 16, 24, 57

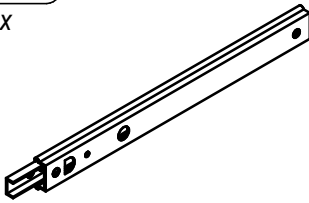

erstellt		geändert		geprüft	
Datum: 12.10.05	Reimar	Datum: 06.02.06	Albrecht	Datum:	

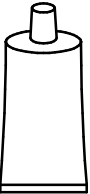
# Mod. 112 - Teileliste - liste de pièces - partlist

<p><b>1114</b> 14x</p> 	<p><b>1116</b> 19x</p> 	<p><b>2218</b> 30x</p>  <p>Ø8x30 mm</p>	<p><b>1255</b> 5x</p> 	<p><b>4162</b> 4x</p> 
<p><b>1317</b> 2x</p>  <p>20x100x1,5</p>	<p><b>1087</b> 8x</p>  <p>Ø3,5x13 mm</p>	<p><b>1111</b> 2x</p>  <p>Ø8x40 mm</p>	<p><b>1289</b> 2x</p>  <p>Ø5,5x55 mm</p>	<p><b>1169</b> 2x</p>  <p>Ø4,3x45 mm</p>
<p><b>4318</b> 1x</p> 	<p><b>4318 1</b> 1x</p>  <p>(a 2x) (b 2x) (c 2x)</p>	<p><b>1238</b> 8x</p>  <p>Ø6,3x13 mm</p>	<p><b>1217</b> 6x</p>  <p>Ø3x25 mm</p>	
<p><b>1244</b> 1x</p>  <p>95x55x60 mm</p>	<p><b>1037</b> 4x</p>  <p>Ø3,0x10 mm</p>	<p><b>4028</b> 2 x</p>  <p>182mm</p>	<p><b>1236</b> 4 x</p>  <p>Ø6,3x11</p>	
<p><b>2223</b> 12x</p>  <p>15x120 mm</p>	<p><b>1243</b> 32x</p>  <p>Ø3,5x25 mm</p>	<p><b>4271</b> 1x</p> 	<p><b>1235</b> 2 x</p>  <p>M4x8</p>	

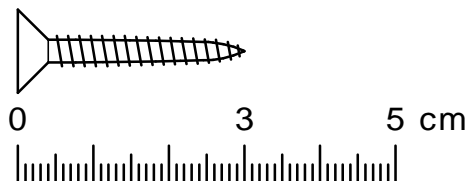

# Mod. 112 - Teileliste - liste de pièces - partlist

**5060**  
3x

**5061**  
3x

**1319**  
12x

M4x35 mm

Dekor:  
02, 11, 12, 13, 16,  
19, 24, 54, 57,

**4474** Dekor: 11, 87,  
**4475** Dekor: 12, 13, 19,  
2x

**1045**  
6x

M4x25 mm

**5047**  
3x

Dekor: 16, 24, 57,

**5415**  
3x

Dekor: 02,

**1133**  
6x

M4x21 mm

**5128**  
3x

Dekor: 04

**4196**  
3x

Dekor: 04,

**5116**  
3x

Dekor: 04

**1222**  
18x

M4x30 mm

erstellt		geändert		geprüft	
Datum:	12.10.05	Reimar	Datum:		Datum:

# Mod. 112 - Montageschritte - ordre de montage - assembly instructions

## 1.

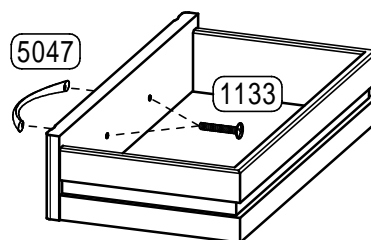
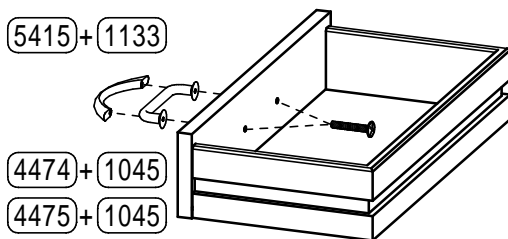
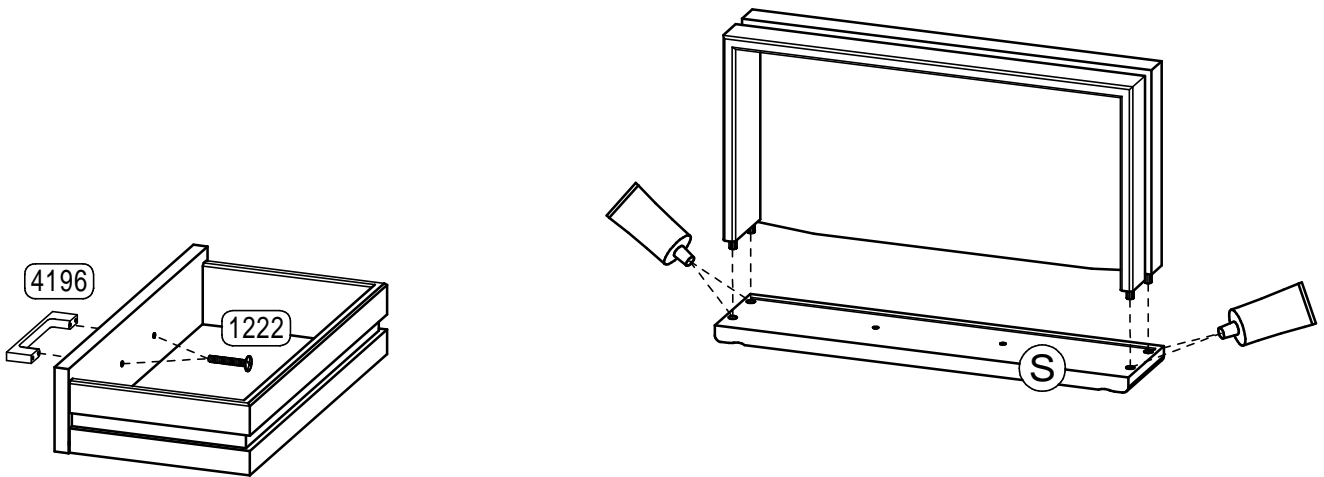
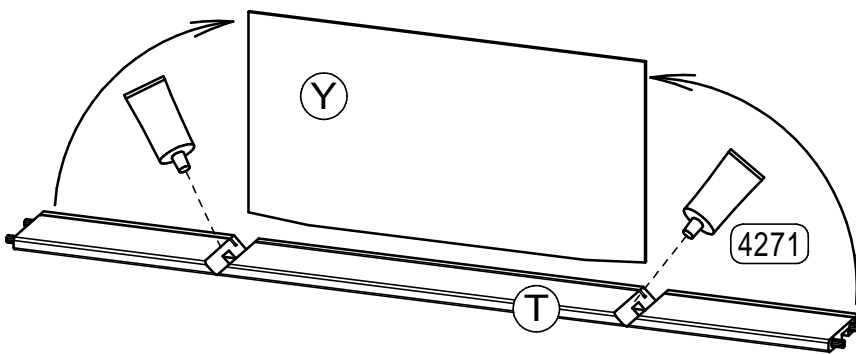
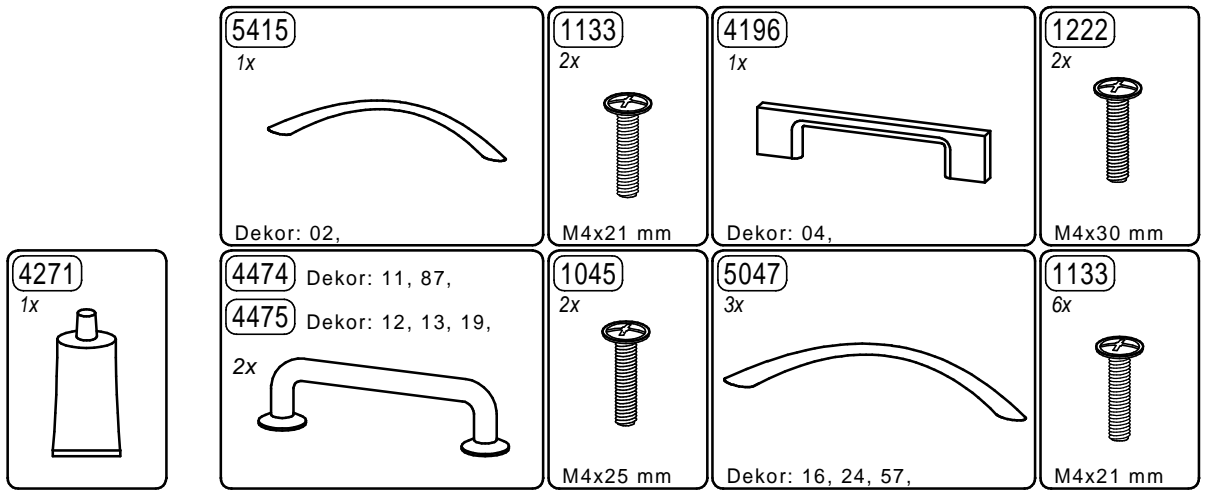

30 min.



## 6

erstellt		geändert		geprüft	
Datum: 12.10.05	Reimar	Datum: 06.02.06	Albrecht	Datum:	

**2.**

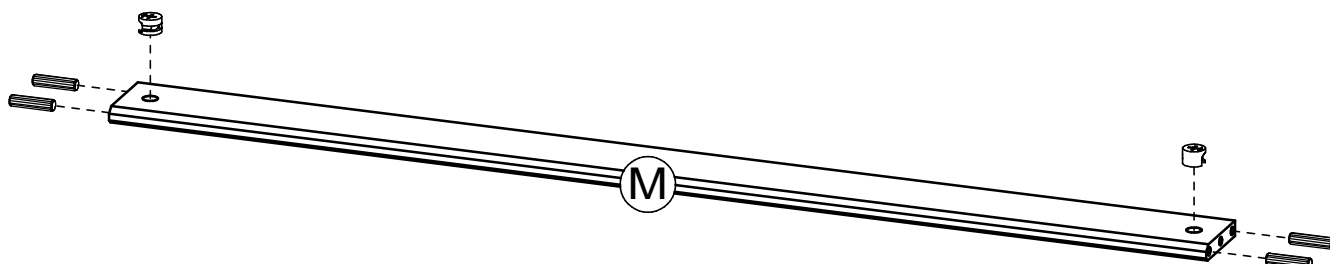
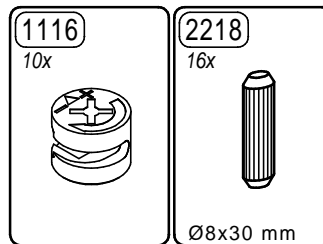

**2x**

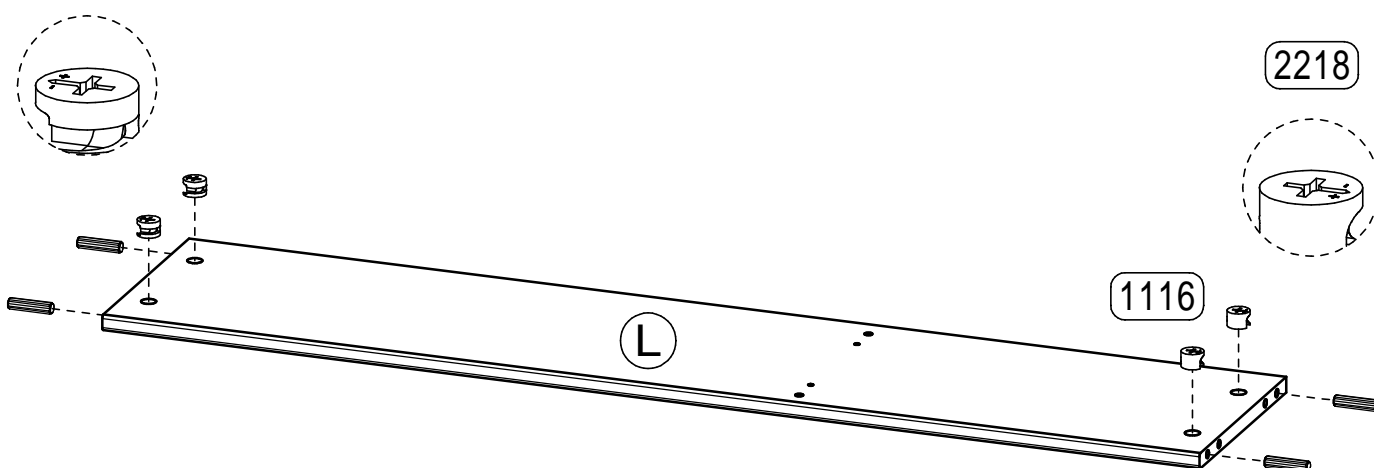
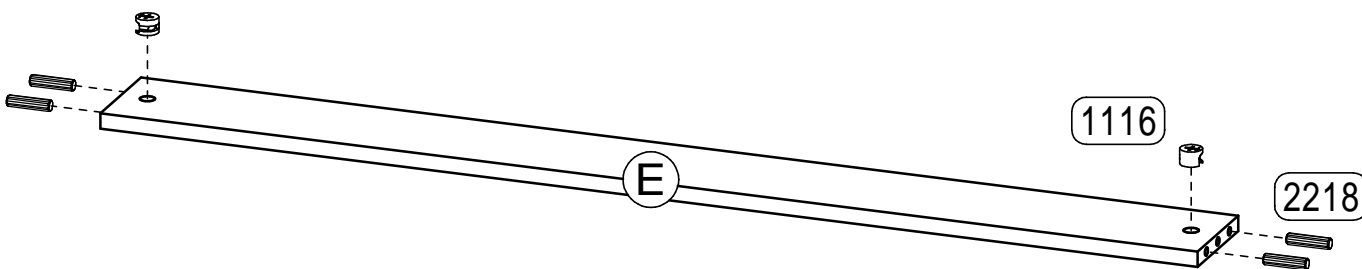

erstellt		geändert		geprüft	
Datum: 12.10.05	Reimar	Datum: 06.02.06	Albrecht	Datum:	

**3.**

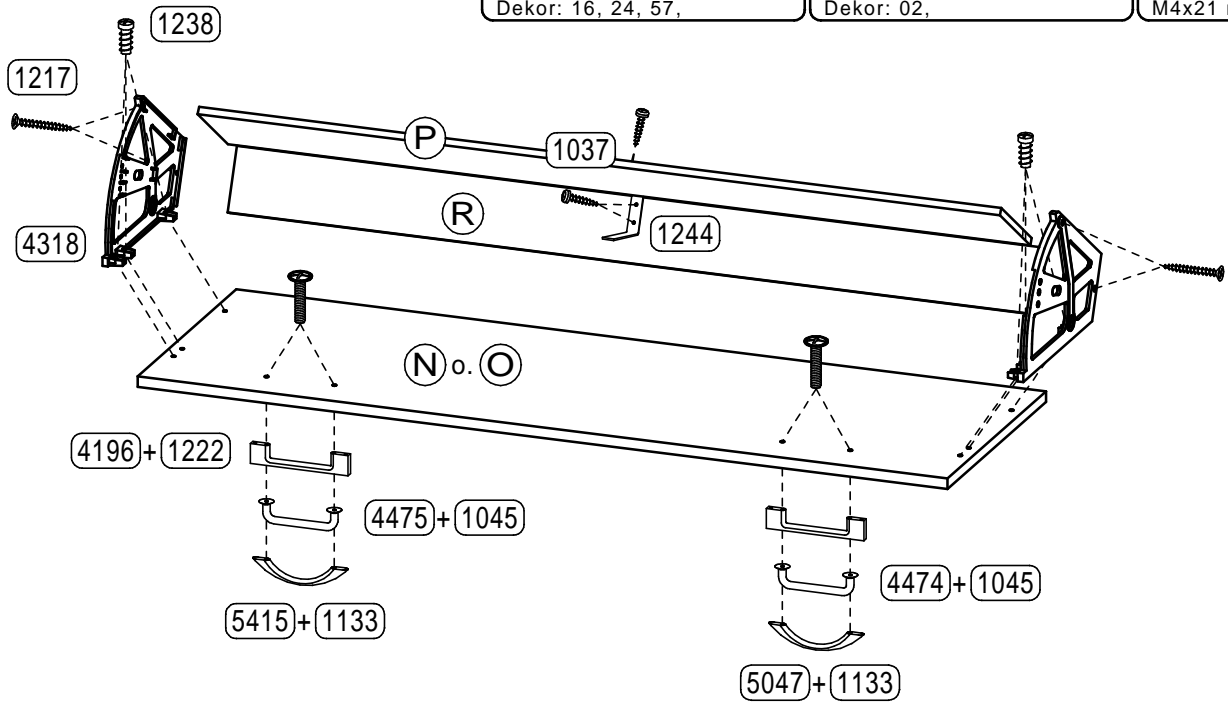
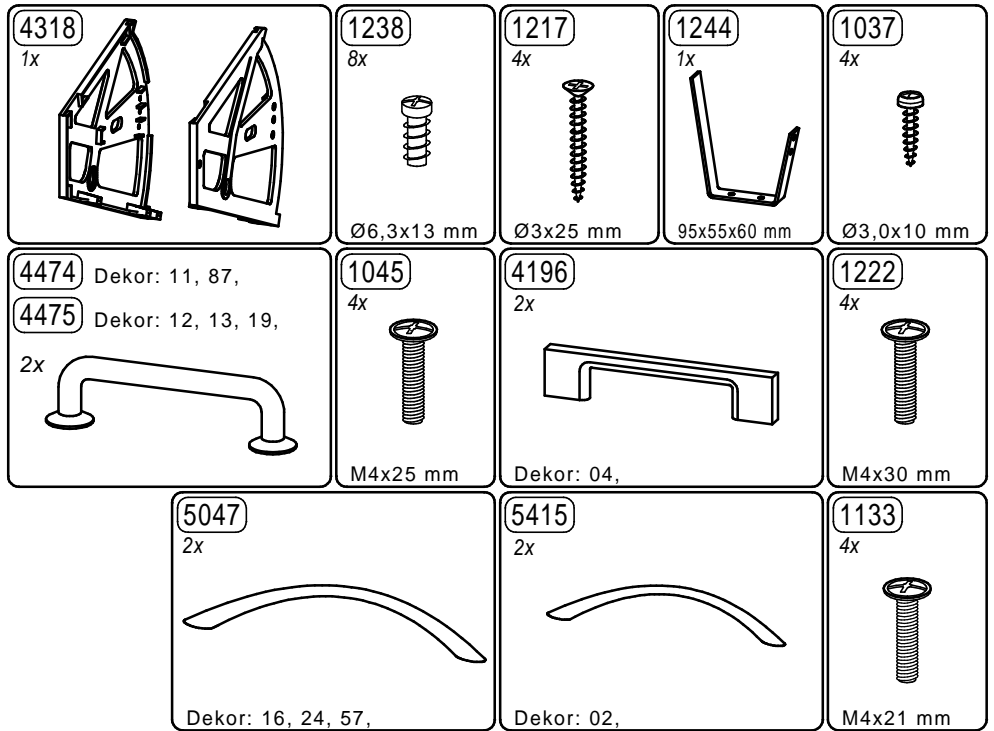

**4.**

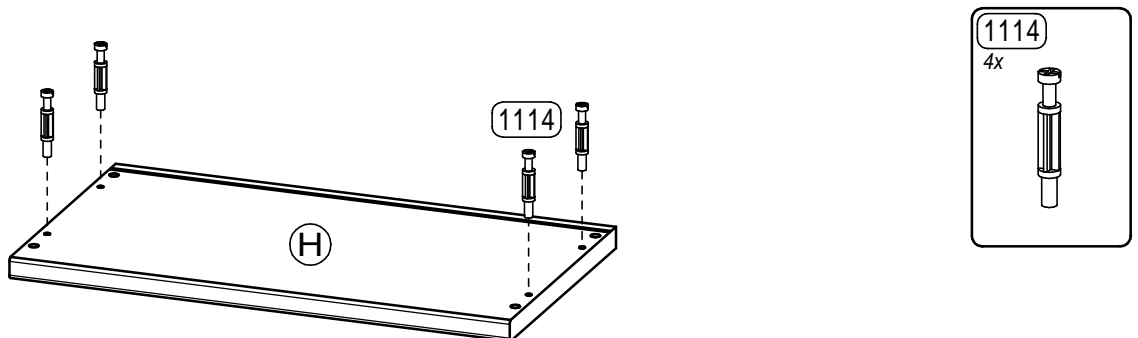

**8**

erstellt		geändert		geprüft	
Datum: 12.10.05	Reimar	Datum: 06.02.06	Albrecht	Datum:	

**5.**

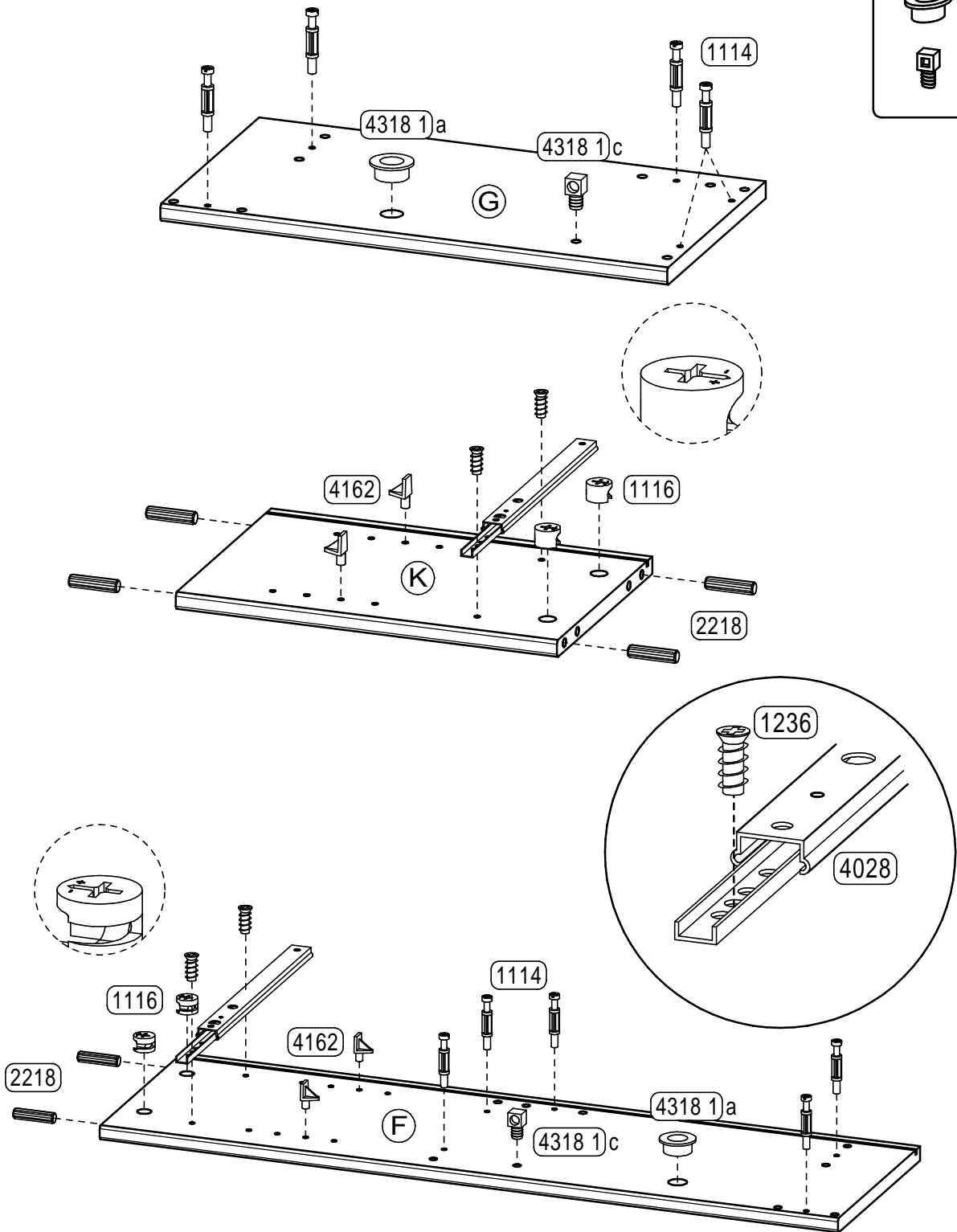
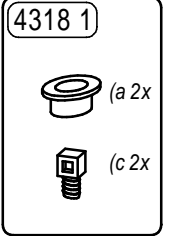
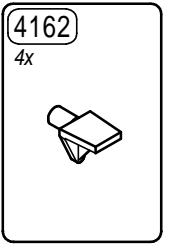
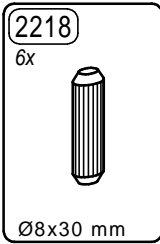
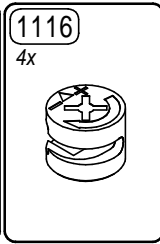
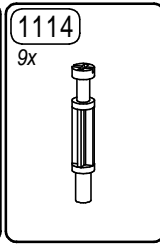
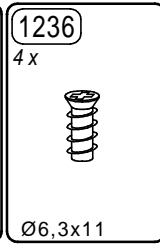
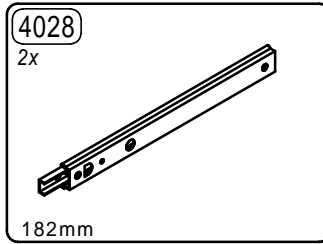

erstellt		geändert		geprüft	
Datum: 12.10.05	Reimar	Datum: 06.02.06	Albrecht	Datum:	

6.

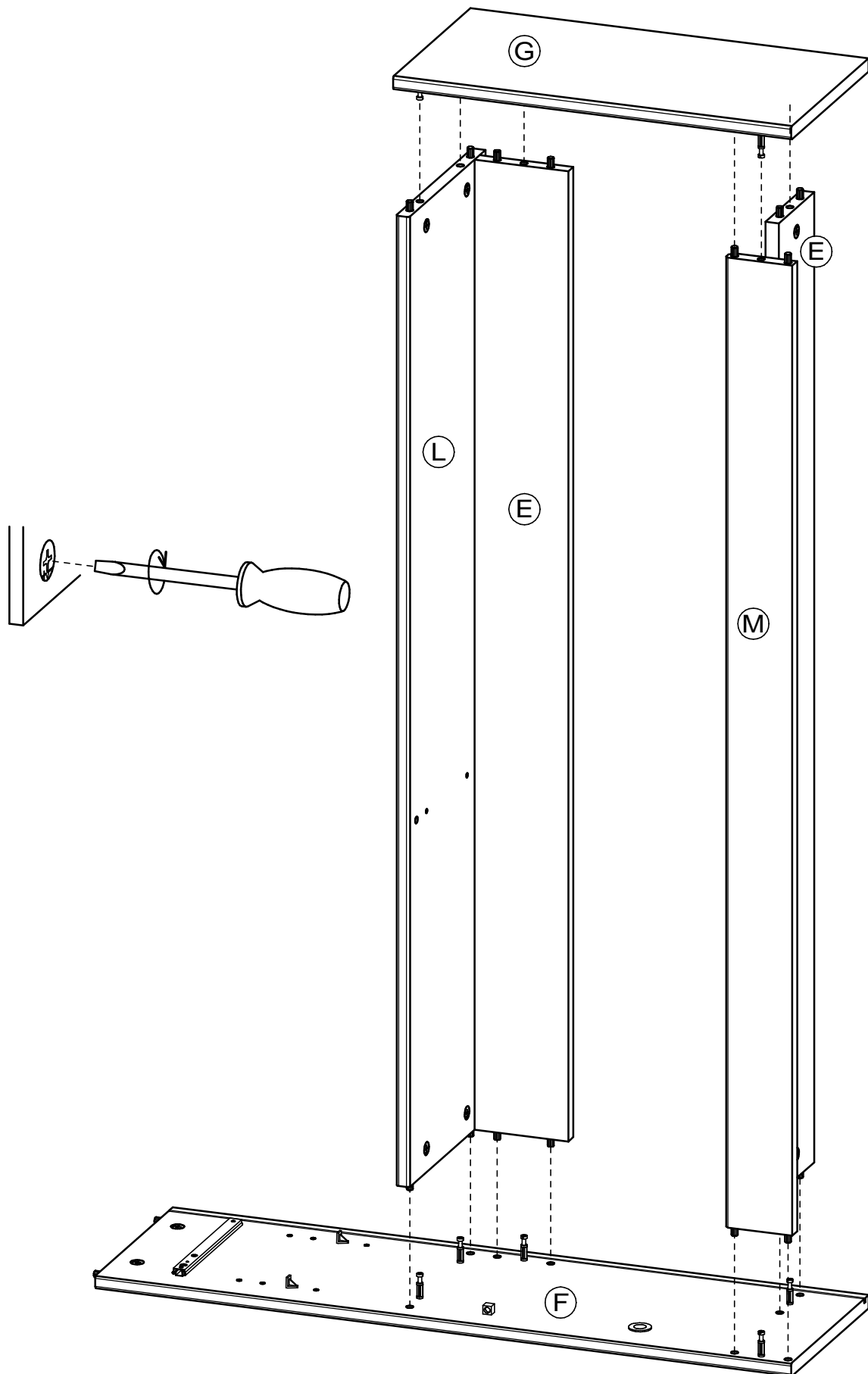

10

erstellt		geändert		geprüft	
Datum: 12.10.05	Reimar	Datum: 06.02.06	Albrecht	Datum:	

7.

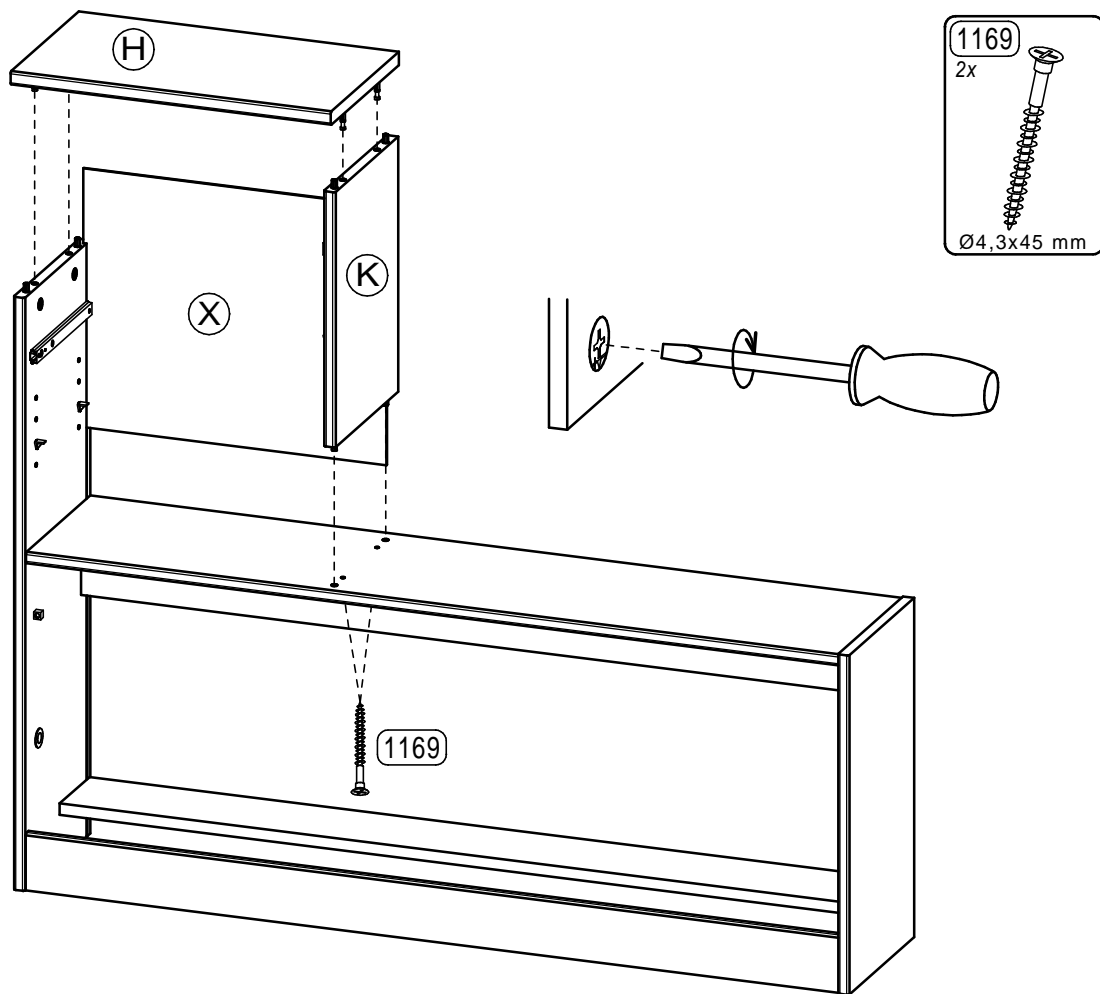

8.

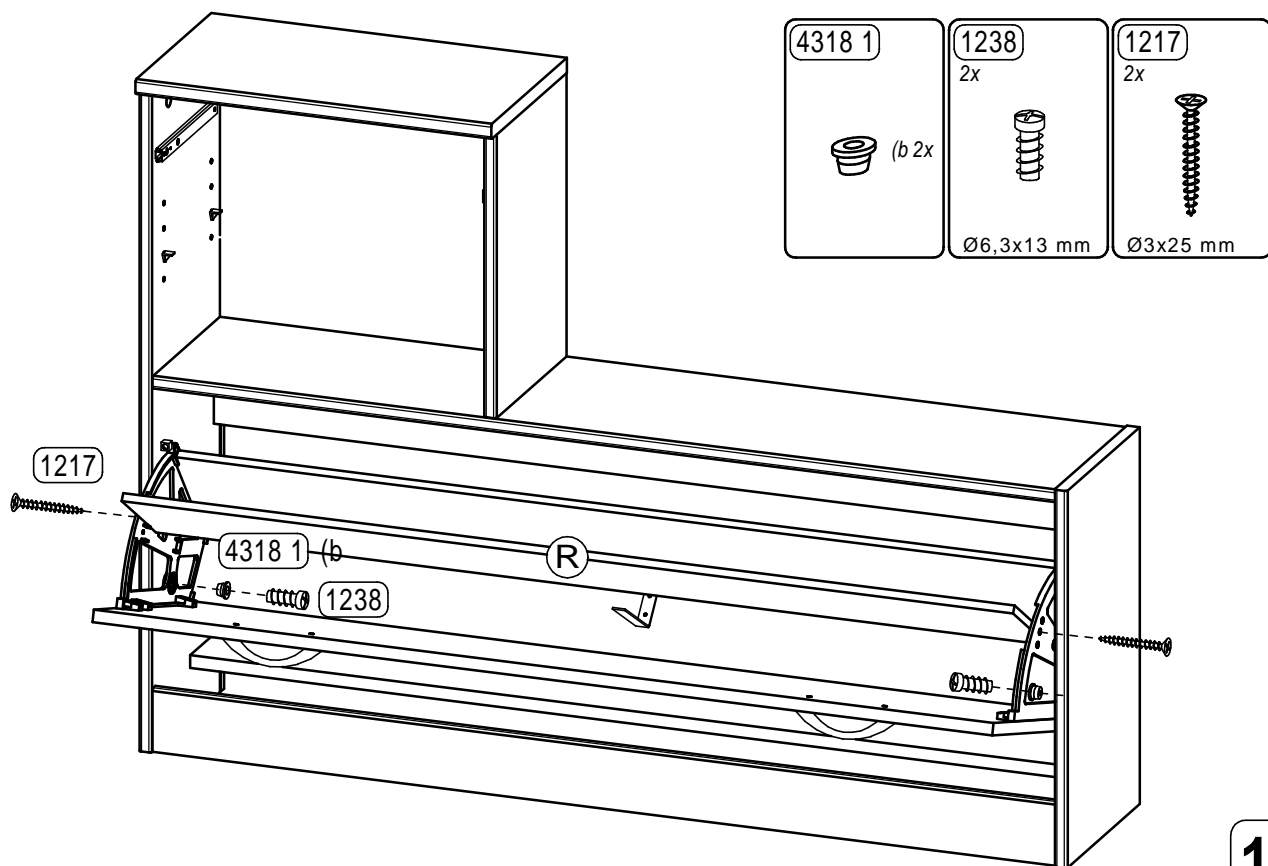

9.

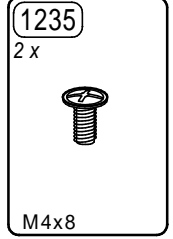
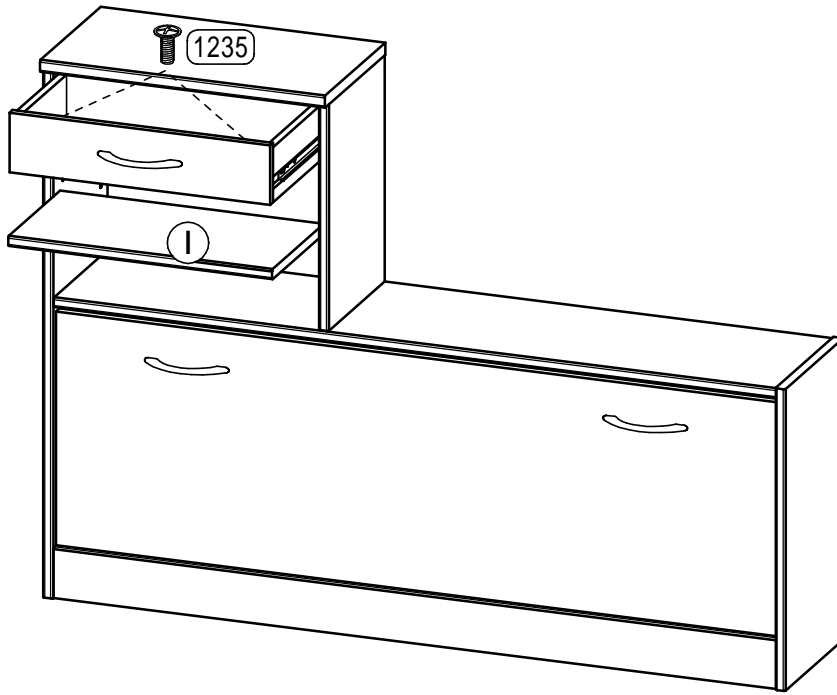

10.

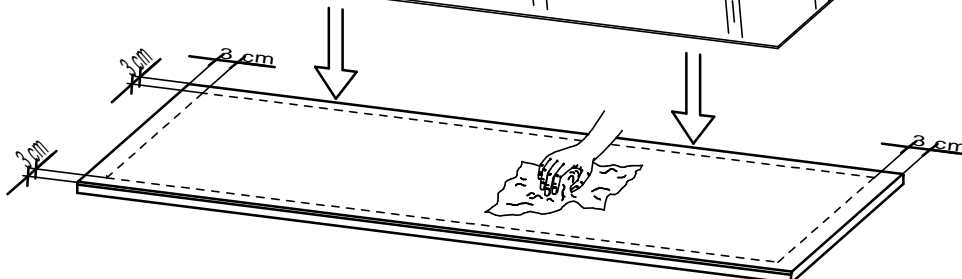
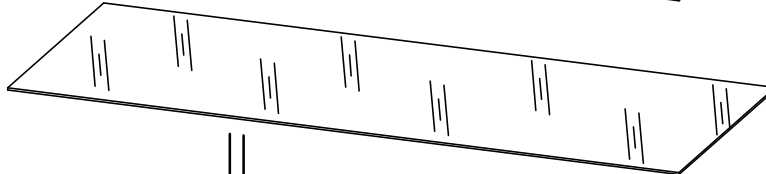
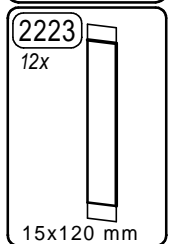
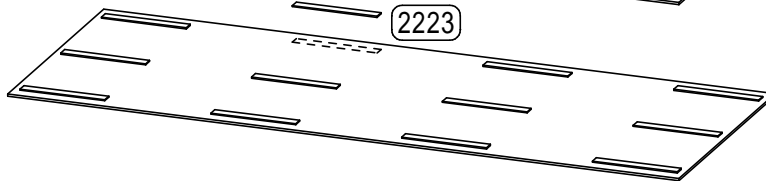
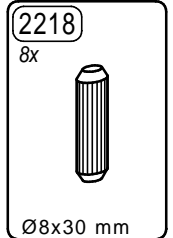
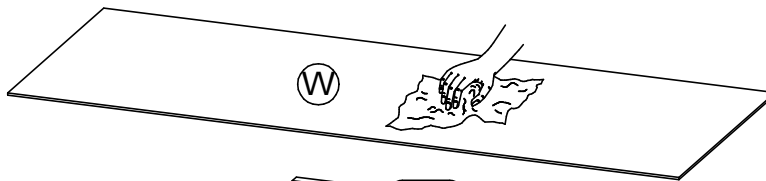
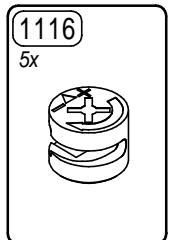
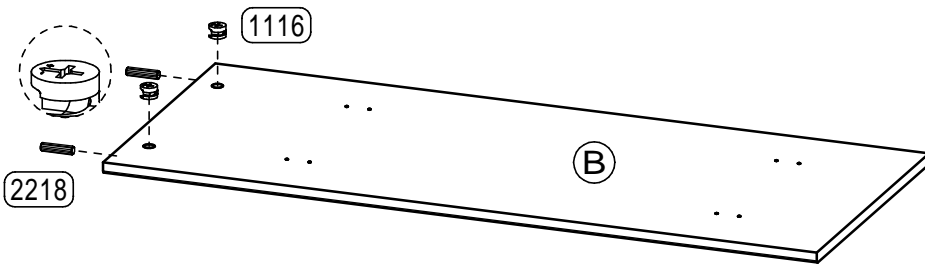

12

erstellt		geändert		geprüft	
Datum: 12.10.05	Reimar	Datum: 06.02.06	Albrecht	Datum:	

11.

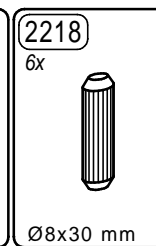
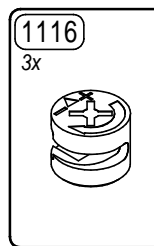
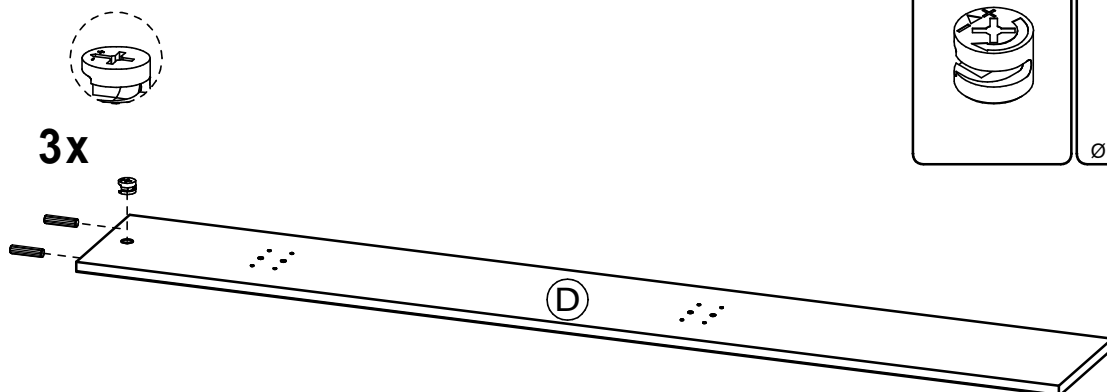

12.

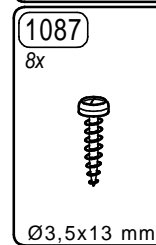
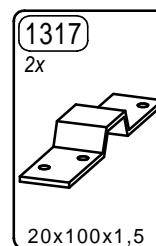
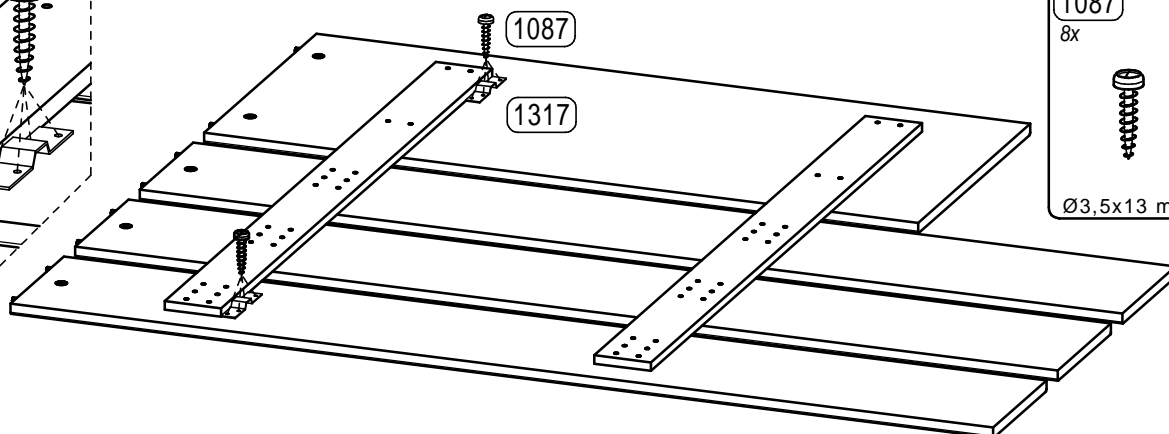
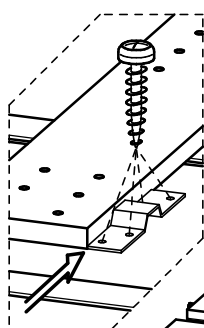
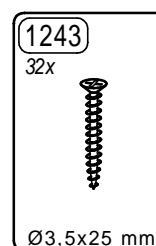
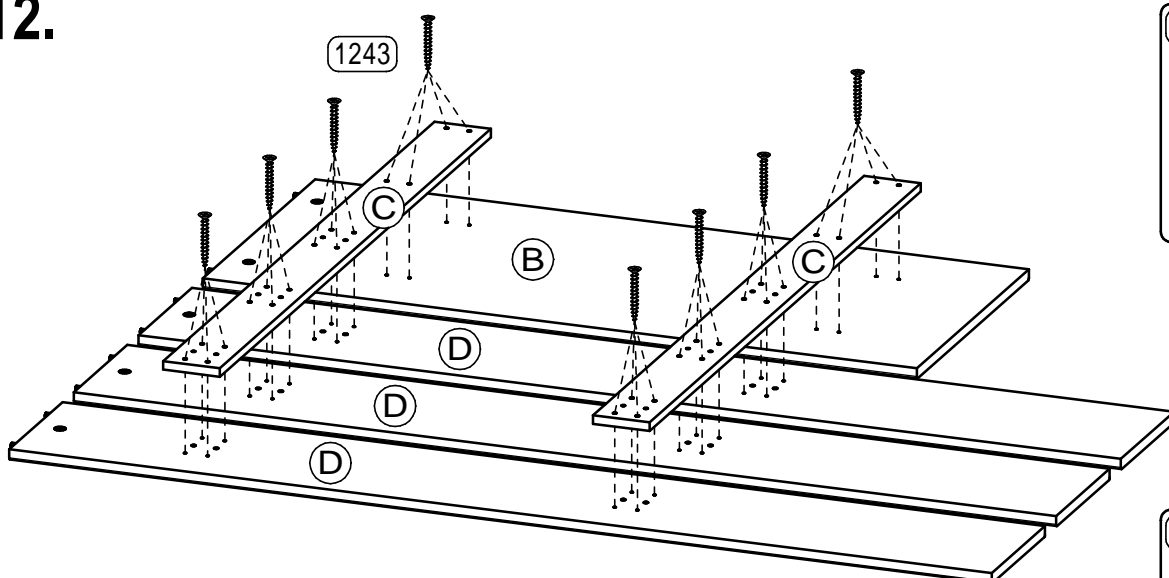

13

# 13.

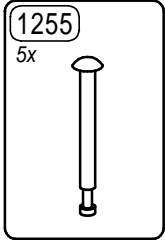
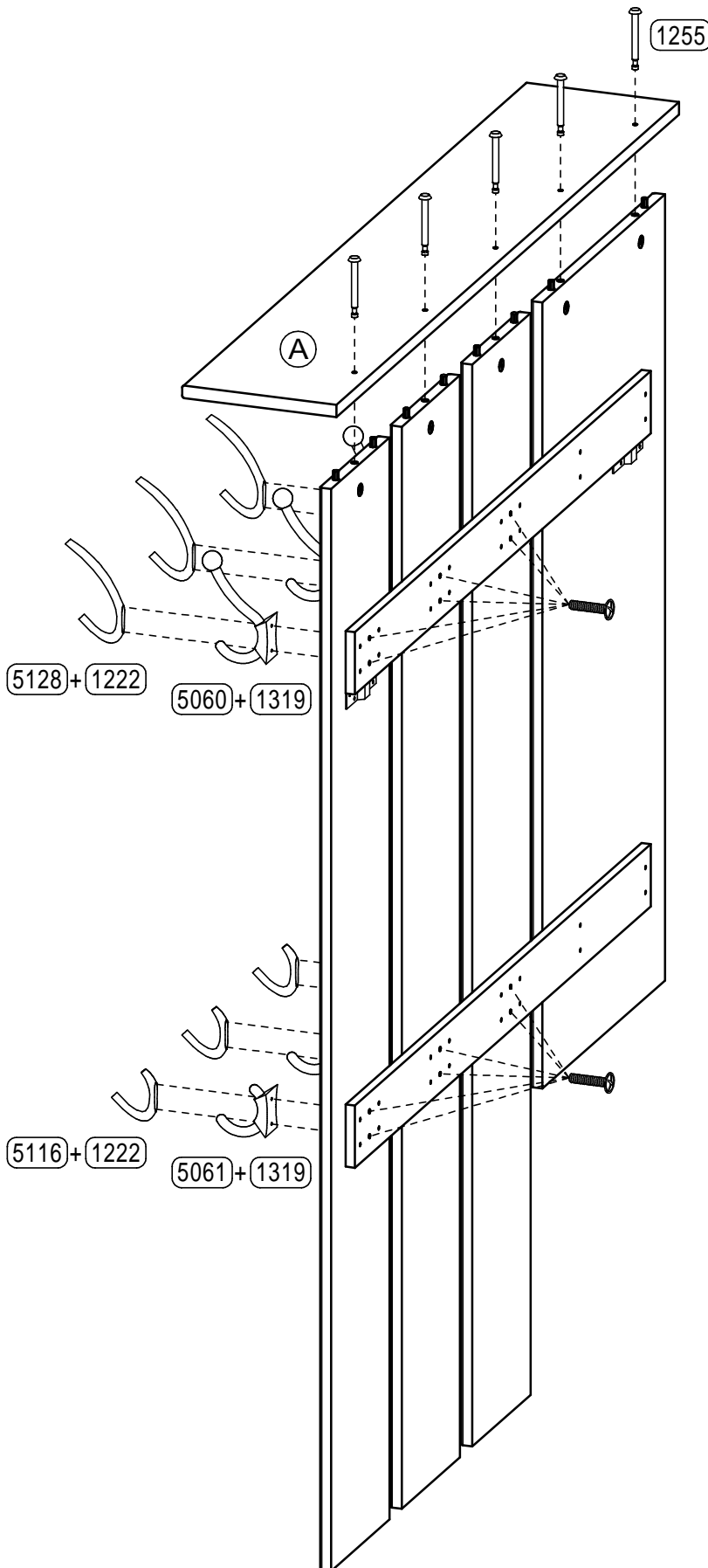

Dekor: 02, 11, 12, 13, 16,  
19, 24, 54, 57,

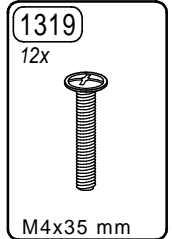
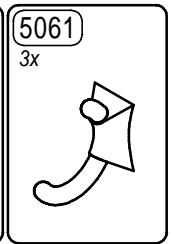
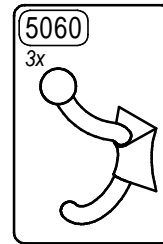

Dekor: 04,

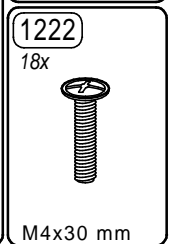
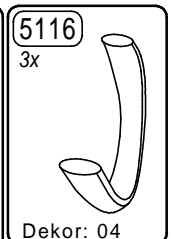
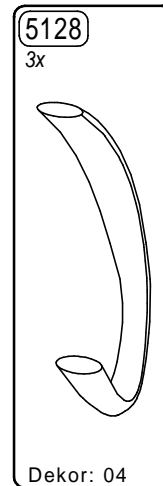

# 14

erstellt		geändert		geprüft	
Datum: 12.10.05	Reimar	Datum: 24.11.05	Reimar	Datum:	

**14.**

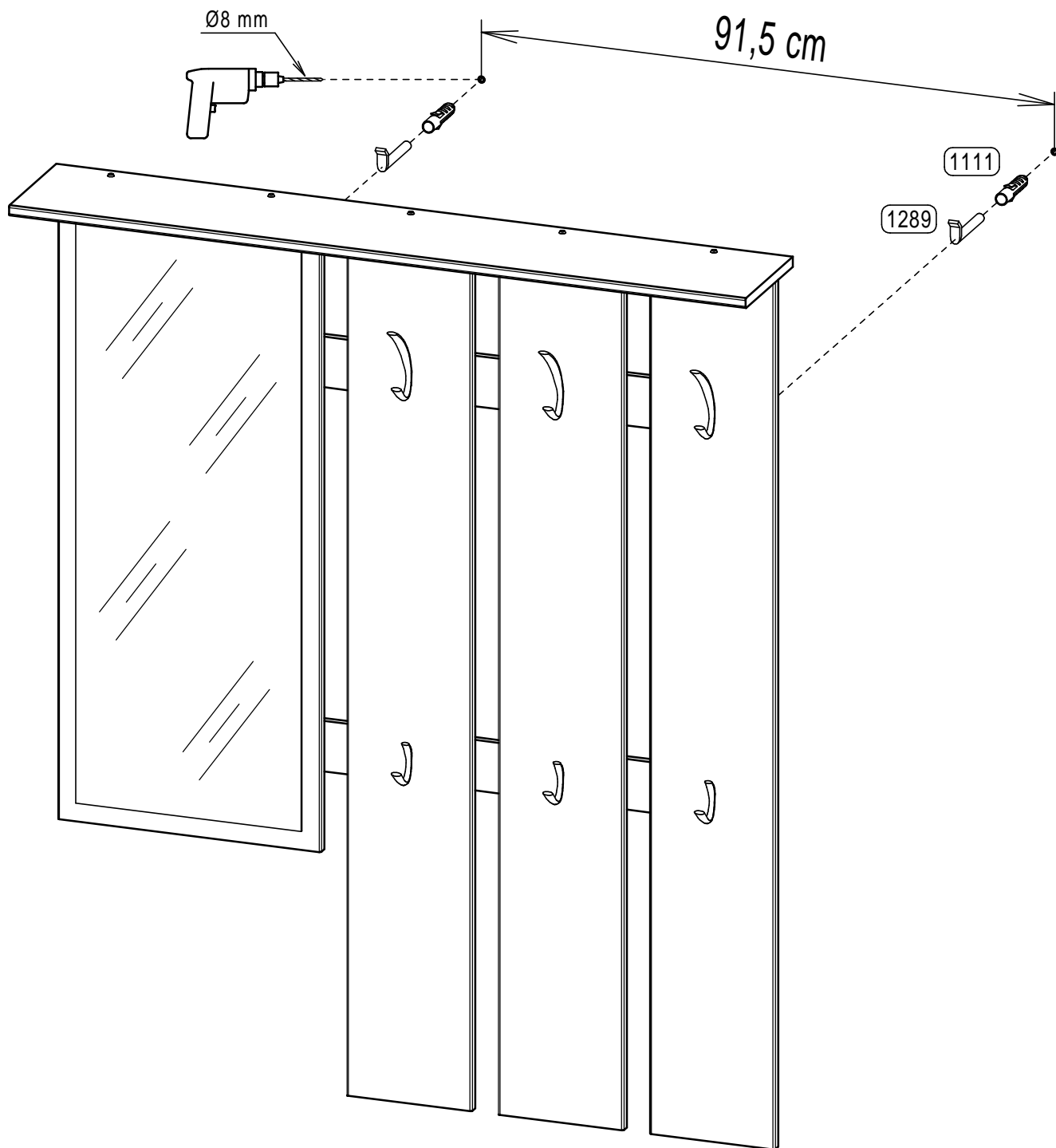
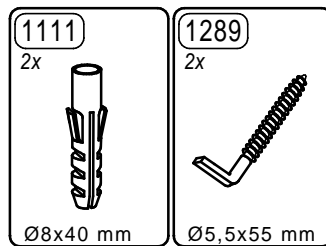

erstellt		geändert		geprüft	
Datum: 12.10.05	Reimar	Datum: 24.11.05	Reimar	Datum:	

# Ersatzteil-Direkt Service

(nur für Deutschland - for germany only - seulement pour Allemagne)

Sehr geehrter Kunde,  
sollte ein Möbelteil bzw. Beschlagteil fehlen oder beschädigt sein, senden Sie uns den Artikel bitte **nicht** zurück, sondern fordern Sie der Einfachheit halber Ersatz direkt bei **GERMANIA** an.  
Tragen Sie Ihren Bedarf in die Tabelle ein und übermitteln Sie uns diese Seite per Post, per Fax, telefonisch oder per e-mail.  
Bitte unbedingt die Modellnummer, Dekornummer (siehe Karton) und die entsprechende Teilebezeichnung (siehe Teilleiste) angeben.

Mod. Nr.: ..... Dekor-Nr.: .....

Möbelteile			
Teil	beschäd.*	fehlt *	Anzahl
Beispiel Z	X		1

Beschlagteile			
Teil	beschäd.*	fehlt *	Anzahl
Beispiel 9137		X	2

\* beschädigt oder fehlt bitte ankreuzen

Absender nicht vergessen :

Name:	Strasse u. Nr.:		
PLZ:	Ort :		
Tel.:	Fax:	e-mail:	

**Unsere Hotline :**

Tel. 05252 84939 und 05252 84962 Fax: 05252 84936

e-mail : service@mygermania.com

**GERMANIA** - Service - Postfach 1160 D 33189 Schlagen

## Sicherheitshinweise Safety instructions Indications de sécurité

**GERMANIA**  
the furniture factory

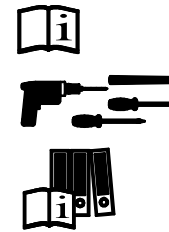

- 1.) Montageanleitung aufmerksam durchlesen  
Please read assembly instruction carefully  
Prière de bien lire la notice de montage du début à la fin
- 2.) Montage nach Montageanleitung durchführen  
Please follow the assembly instruction step by step  
Bien suivre le sens du montage indiqué sur la notice
- 3.) Montageanleitung aufbewahren  
Please save the assembly instruction  
Bien conserver la notice de montage



**ACHTUNG!** Beschlagbeutel und Beschlagteile von Säuglingen und Kindern fernhalten

**ATTENTION!** To avoid suffocation keep plastic bag away from children  
Contains small parts which may be a choking hazard

**ATTENTION!** Toutes les pièces détachées livrées dans le colis être mis hors de portée des bébés des et enfants

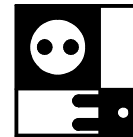

Netzanschluss (230V) nur von einem Fachmann ausführen lassen.  
Sanitäranschluss nur von einem Fachmann ausführen lassen.  
Mains connection (230V) has to be done by an expert.  
Sanitary installation has to be done by an expert.  
L'électricité (230V) uniquement à faire par un électricien.  
Installation sanitaire à faire par un spécialiste.

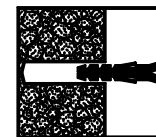

Beiliegendes Befestigungsmaterial eignet sich nur für Massivwände.  
Für andere Wände müssen Spezialdübel verwendet werden.  
Die Festigkeit ist zu Prüfen.

The attached fixing materials is only suitable for solid walls.  
For other Types of walls special dowels have to be used.  
The firmness have to be checked.

Le matériel defixation ci-joint est exclusivement prévu pour des murs pleins( une fixation spéciale est nécessaire pour cloisons placo,...).  
La fermeté est à examiner.

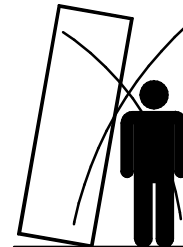

Beiliegende Wandbefestigungen dienen als Kippschutz, unbedingt anbringen!

The attached wall fixing is necessary to avoid tipping and must be fixed!

Les fixations prévues dans le colis préviennent contre le renversement du meuble. Il faut impérativement fixer le meuble au mur, afin d'éviter tout incident!

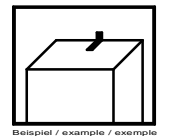

Für Schäden, die durch unsachgemäße Montage entstanden sind, übernehmen wir keine Haftung  
For the damages, which have originatet prom improper assembly, we take over no liability.  
Pour les dommages qui sont nés par le montage incorrect, nous ne prenons en charge aucune responsabilité.