

ASSEMBLY INSTRUCTION FOR 1.6-756A-NS-KD (LOZKO MADRYT)

Note:

- Read instructions carefully.
- Identify clearly each component especially those that are similar.
- Separate and identify each component from the hardware pack and see each one in its proper location before fastening.
- Do not over tighten the screws or bolts when assembling.



2 Persons

TOOL REQUIRED

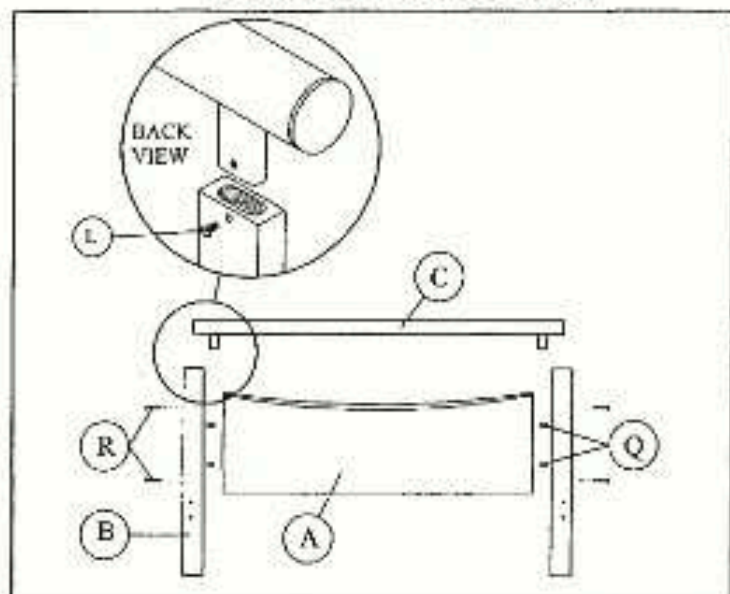
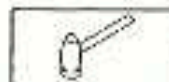

Step 1 Assemble the bed frame component as shown.

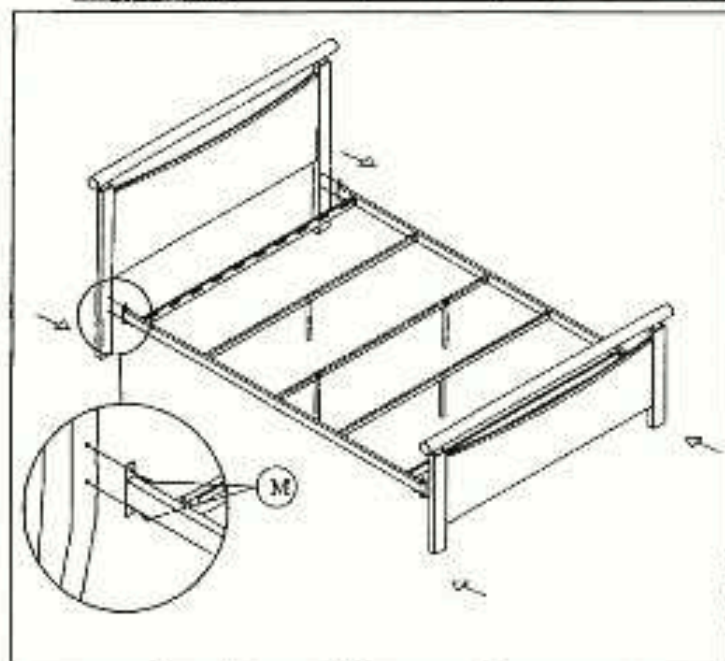

Step 4 Assemble bed base into bed frame and tighten all bolts.

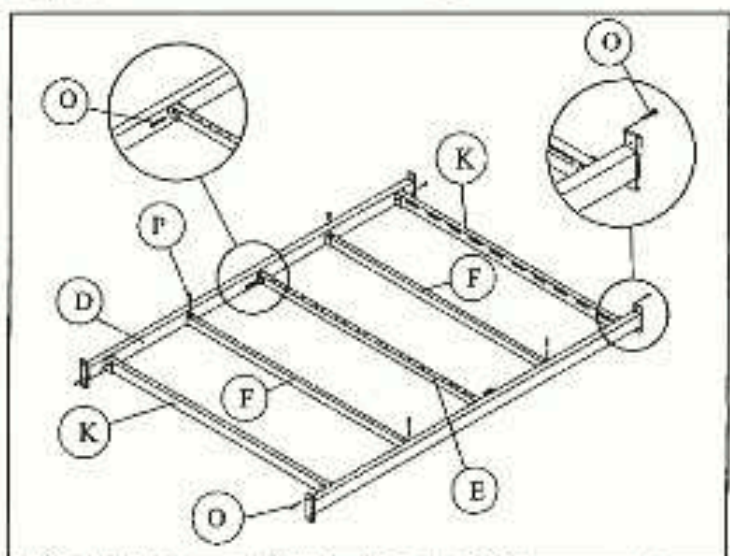

Step 2 Fix both side rails and cross bar E with bolt O as above diagram. Put cross bar F into side rail and fix in bolt P. After that put end cross bar K to the end of side rail and tighten with bolt O.

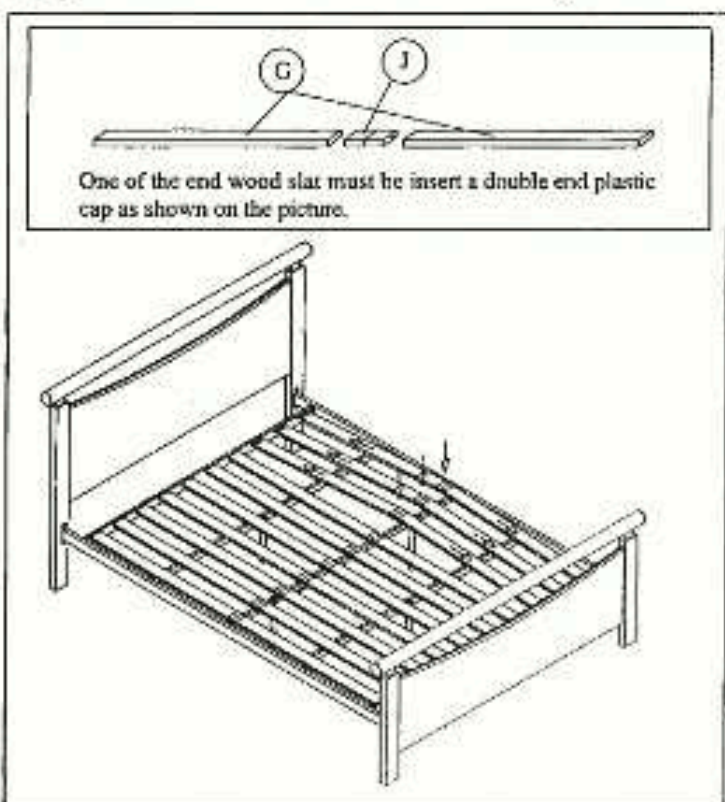

One of the end wood slat must be insert a double end plastic cap as shown on the picture.



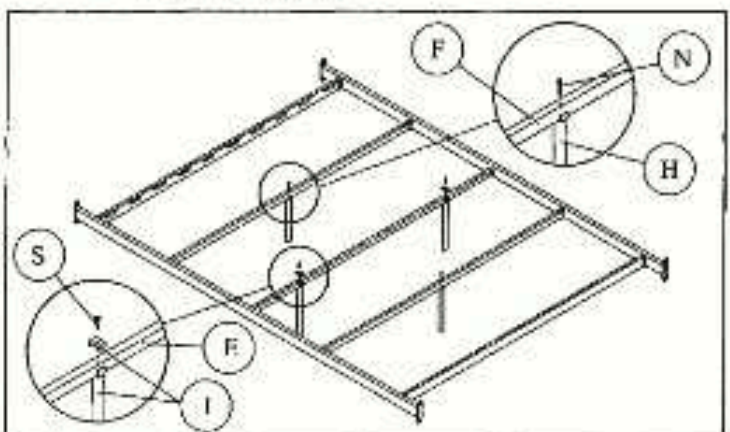















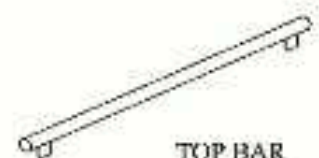



Step 5 Once wood slats have been inserted into the plastic caps, fix one end of wood slat into the hole of end cross bar K and the other end to the other end cross bar. After that fix the plastic cap to the center cross bar by pressing it accordingly to the default holes. Ensure the plastic cap's pin aimed to the hole.

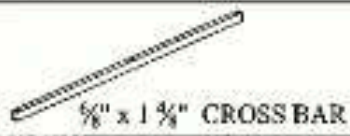

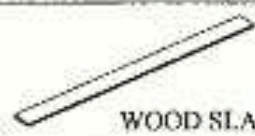
Step 3 Fix bed support legs as shown on the picture.

Please follow our Assembly Instruction procedure for easier assemble.

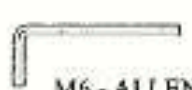
HARDWARE & PART LIST FOR 1.6-756A-NS-KD (LOZKO MADRYT)

NO	PART	QTY	NO	PART	QTY
A	 HEAD FRAME	1 pc	J	 Double end plastic cap	10 pcs
	 FOOT FRAME	1 pc	K	 1" x 2" CROSS BAR	2 pcs
B	 HEAD POST	2 pcs	L	 M6x15mm	4 pcs
	 FOOT POST	2 pcs	M	 M8x25mm	8 pcs
C	 TOP BAR	2 pcs	N	 M6x45mm (assembled)	2 pcs
D	 SIDE RAIL	2 pcs	O	 M6x40mm (assembled)	6 pcs
E	 1" x 1" CROSS BAR	1 pc	P	 M6x50mm (assembled)	4 pcs
F	 5/8" x 1 1/4" CROSS BAR	2 pcs	Q	 M8x30mm WOOD DOWEL	8 pcs
G	 WOOD SLAT	20 pcs	R	 M6x100mm	8 pcs
H	 SHORT SUPPORT LEG	2 pcs	S	 M8x40mm (assembled)	2 pcs
I	 LONG SUPPORT LEG	2 pcs		 M6 - ALLEN KEY	1 pc
				 M8 ALLEN KEY	1 pc