

MONTAGEANLEITUNG INSTRUKCJA MONTAŻOWA

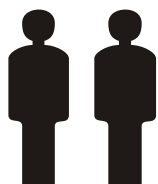

2 Personen
2 Osoby

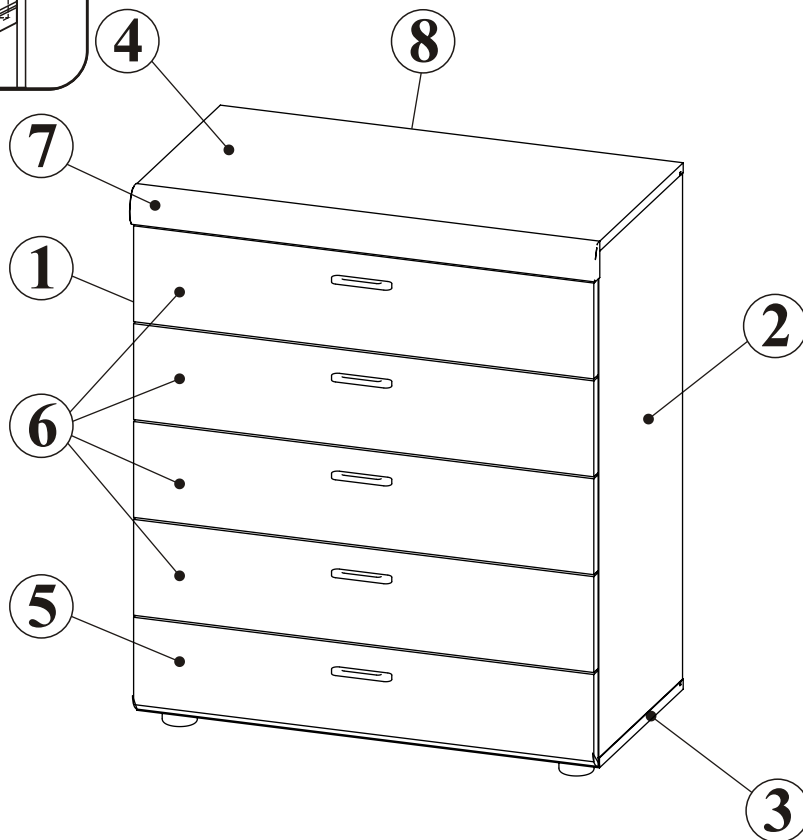
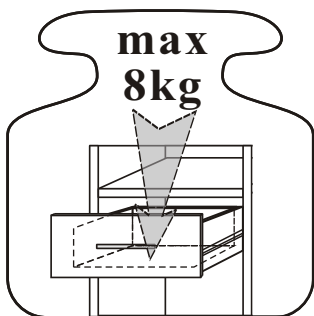
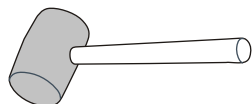
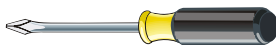
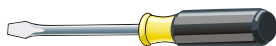
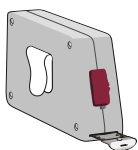

Max. zulässige Belastungen
 von Einlegeböden in kg:
 Maksymalne obciążenie półek w kg:

Stärke/Gr. Länge/Dł. mm	Spanplatte/Płyta		
	15	18	22
0<400			
401<600	40	40	40
601<800	24		
801<1000	15	30	

Pflegehinweis!
 Bitte nur mit einem Staubtuch
 oder einem feuchten Lappen reinigen.
KEINE scheuernde
 Putzmittel verwenden !

**Wskazówka dotycząca
 pielęgnacji!**
 Proszę czyścić tylko suchą
 lub lekko wilgotną szmatką do kurzu.
 Nie używać żadnych środków szorstkich !

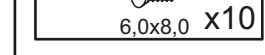
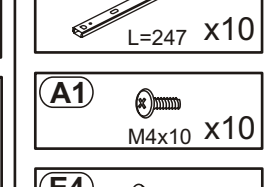
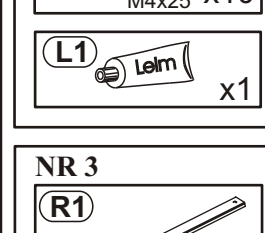
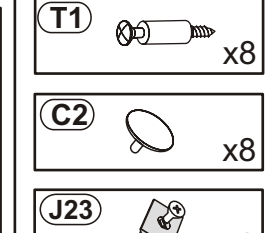
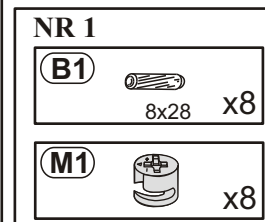
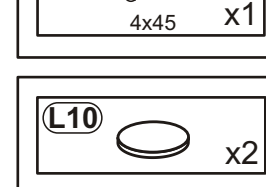
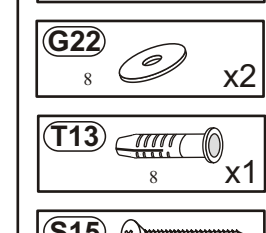
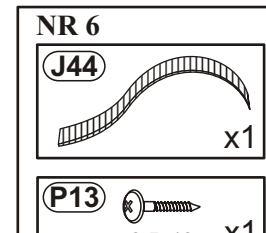
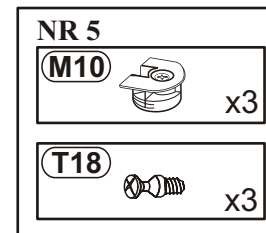
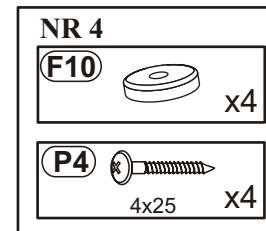

1

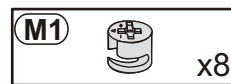
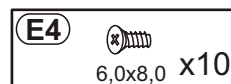
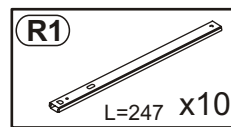
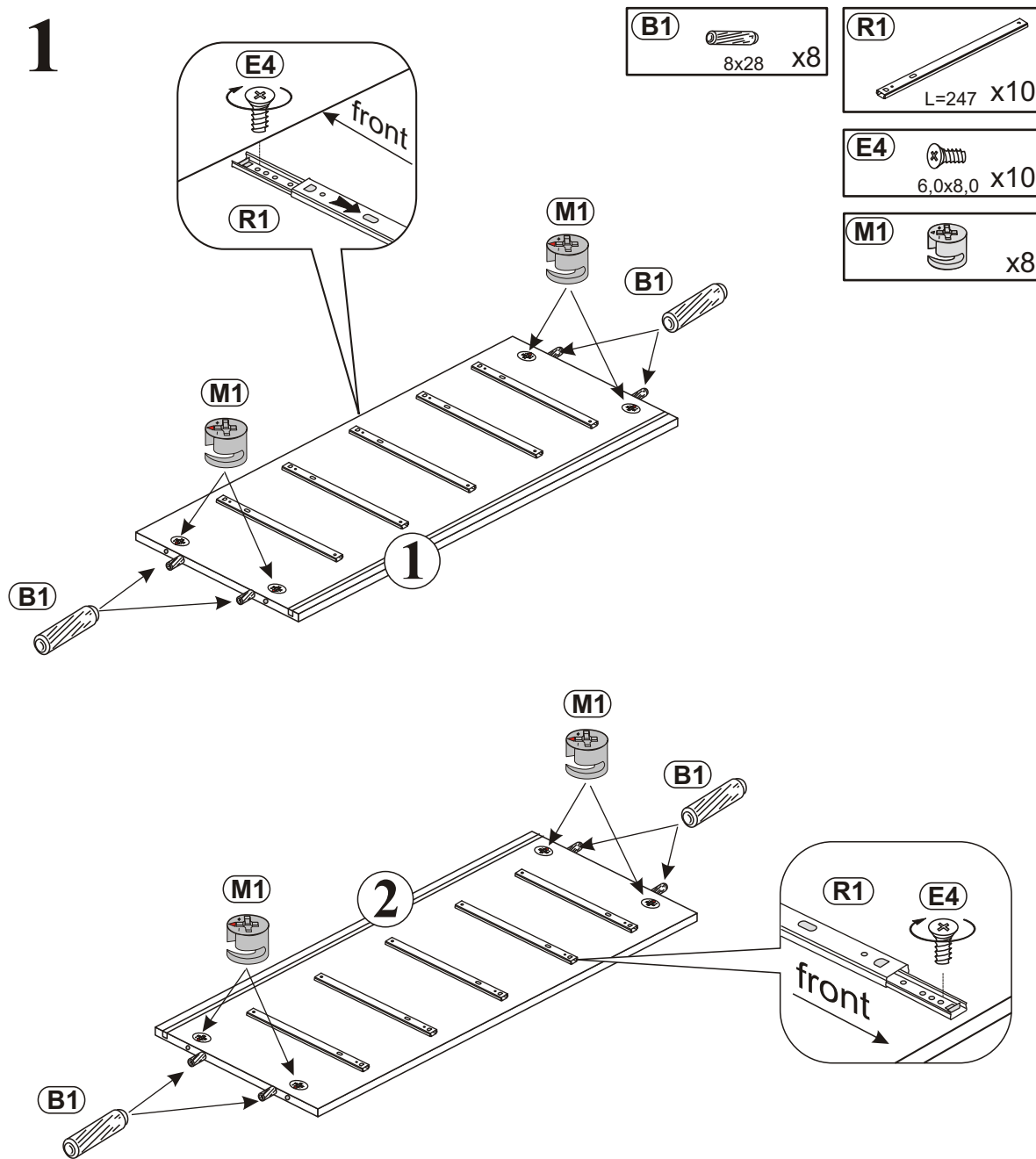

2

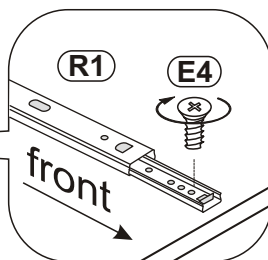
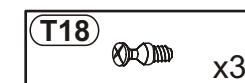
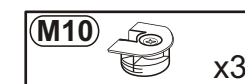
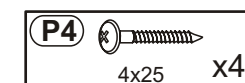
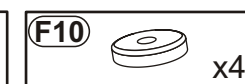
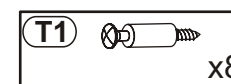
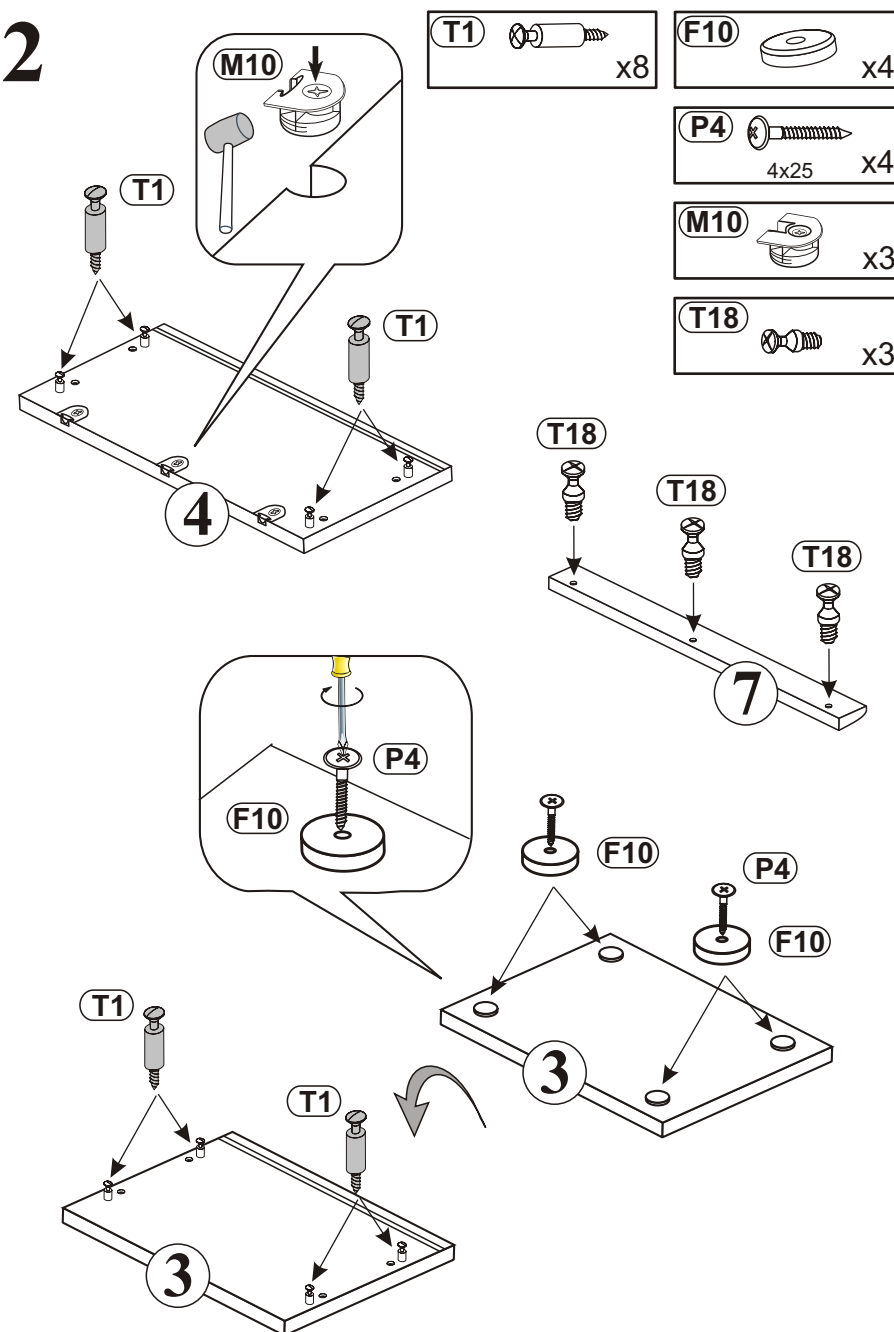

3

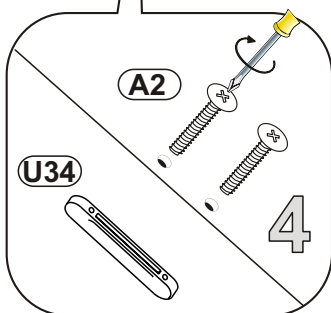
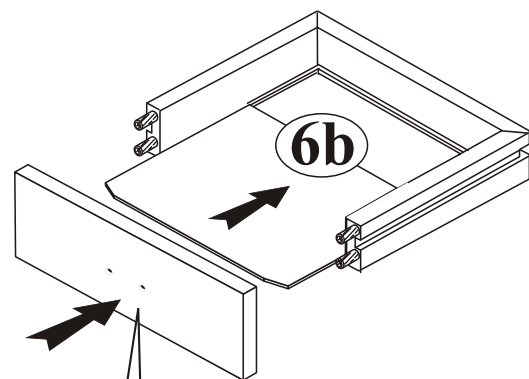
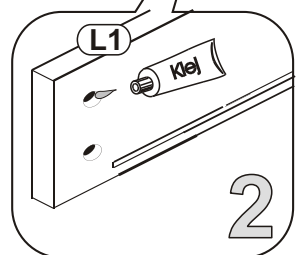
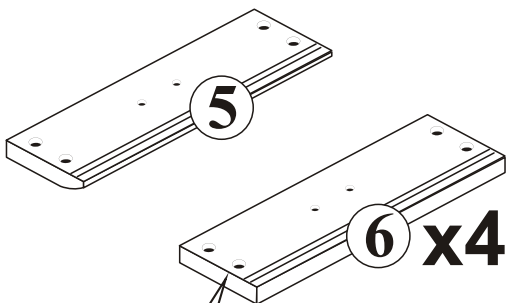
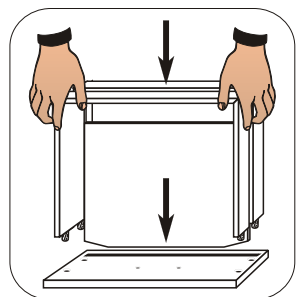
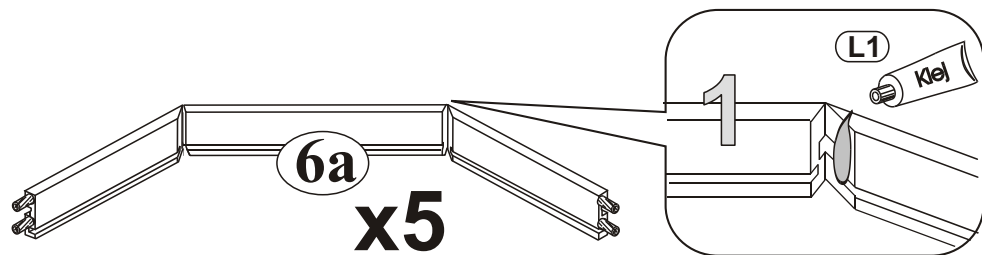
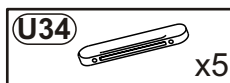
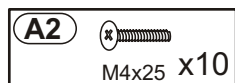
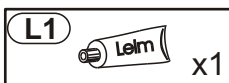

4

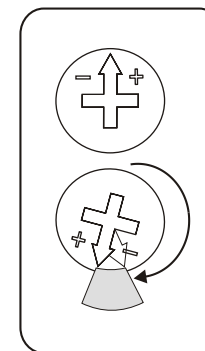
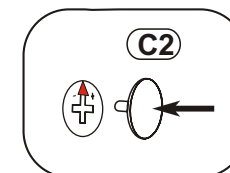
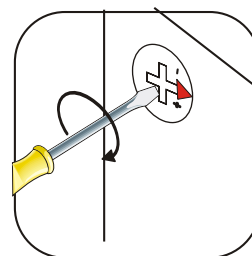
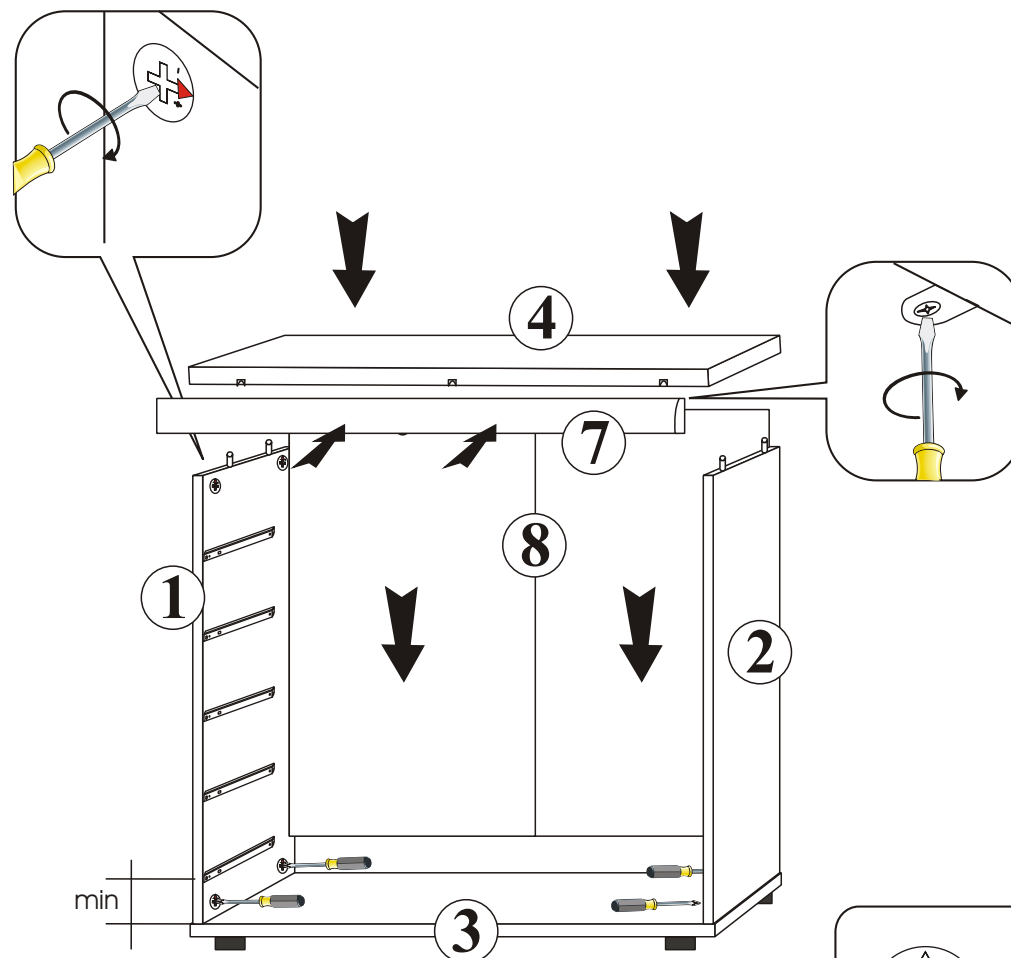

5

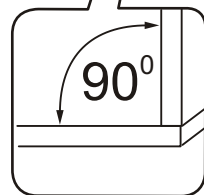
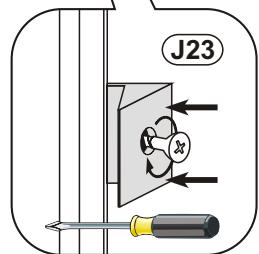
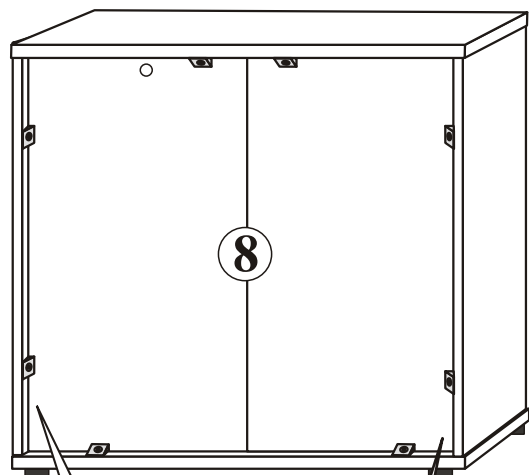

6

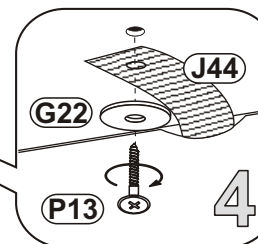
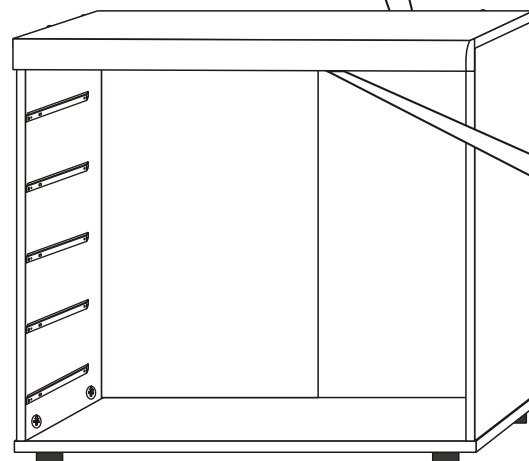
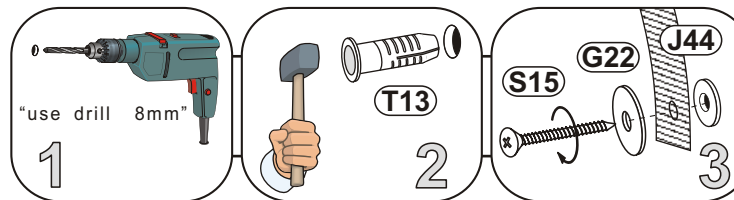

(PL) Załączone kołki do zawieszania bryty, do stosowania wyłącznie do ścian betonowych, do innych ścian należy odpowiednio dokupić.
(GB) Attached dowels to hang up unit are for concrete walls only. For other types of walls, appropriate dowels must be purchased

(D) Die beigefügten Dübel zum Aufhängen des Elements dürfen nur bei Betonwänden eingesetzt werden, bei anderen Wandarten müssen entsprechende Dübel zugekauft werden.
(F) Les chevilles jointes, pour pendre l'élément, sont pour les murs bétonnés exclusivement; pour autres murs il faut acheter chevilles adéquates

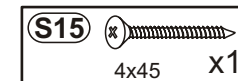
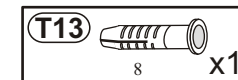
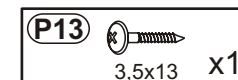
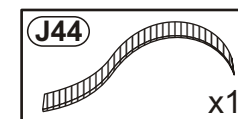

7

