

# Montageanleitung

Notice de montage

Assembly instruction

**GERMANIA**<sup>®</sup>  
the furniture factory

## Garderobenpaneel 1364

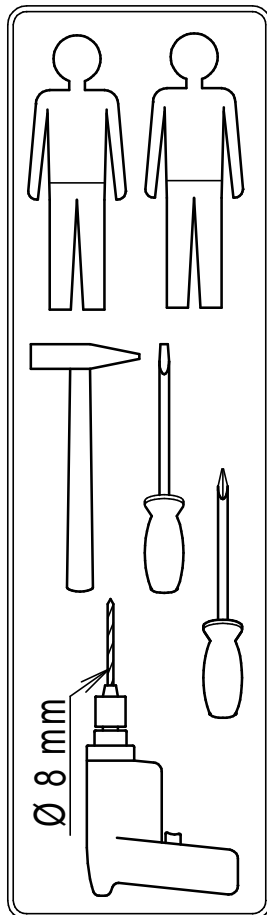
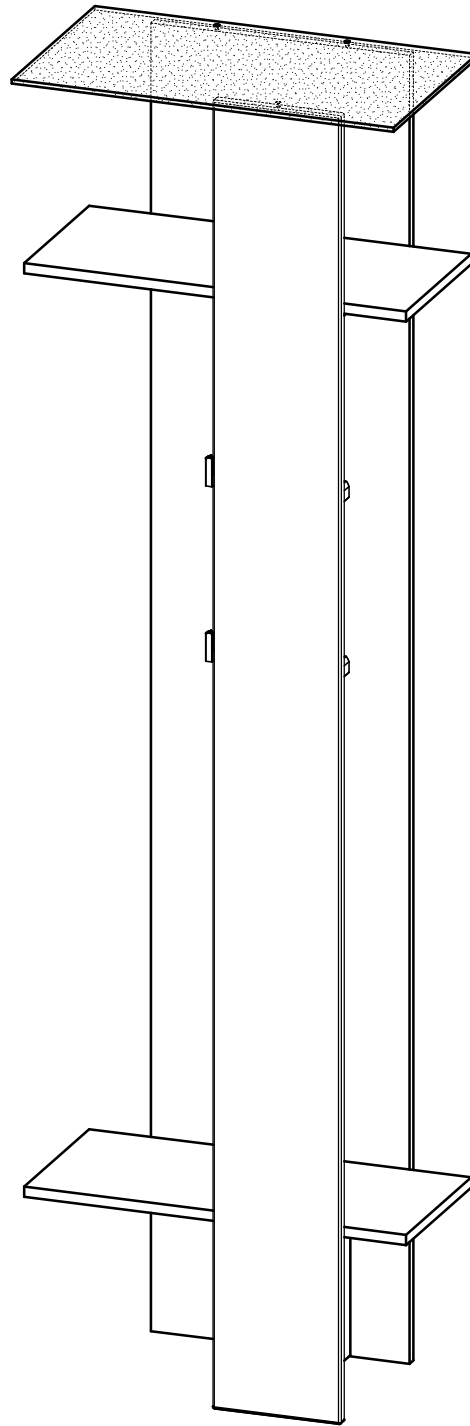

Bitte die Sicherheitshinweise auf der letzten Seite beachten!

Please note: safety instructions on the last page!

Prière de suivre les instructions de sécurité figurant sur la dernière page!

erstellt

geändert

geprüft

Datum: 15.06.10

Datum:

Datum: 21.06.10

Mod. 1364 **Teileliste** - liste de pièces - partlist

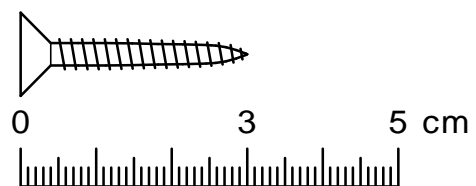
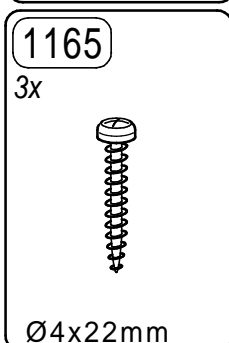
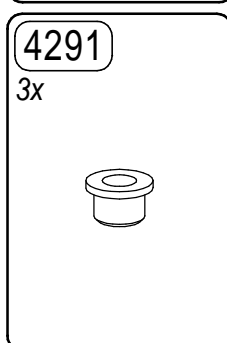
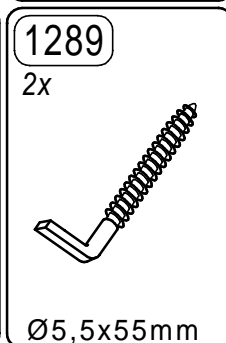
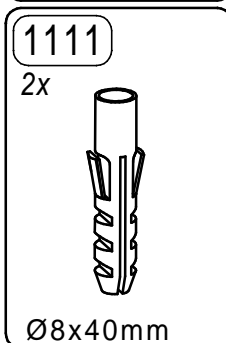
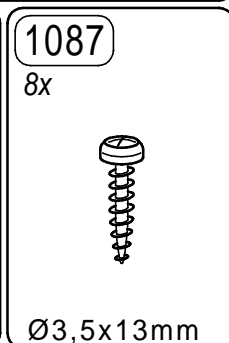
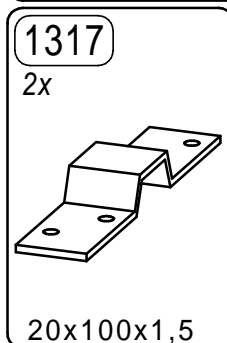
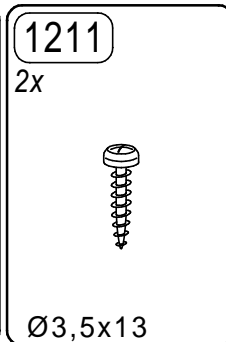
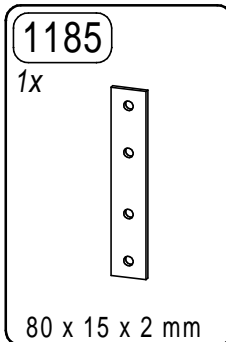
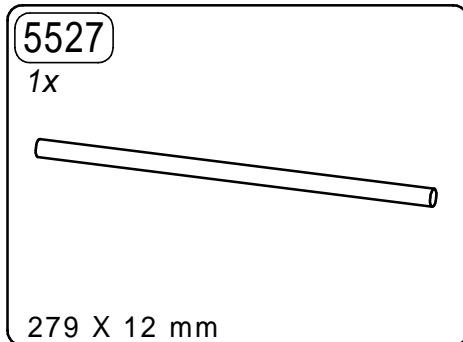
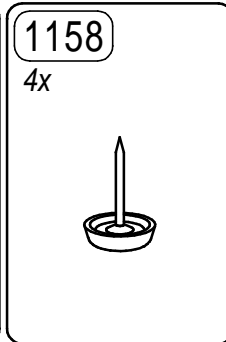
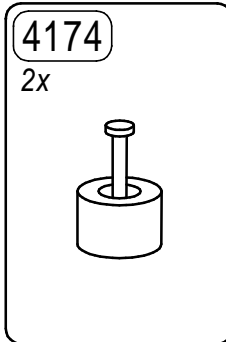
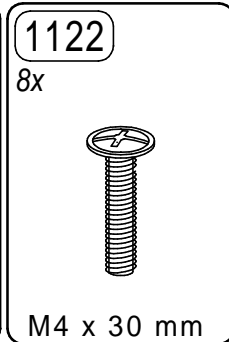
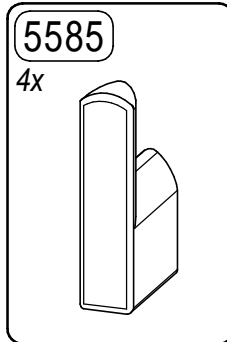
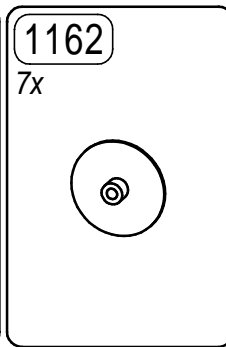
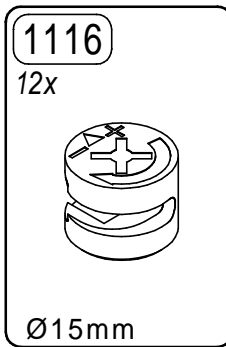
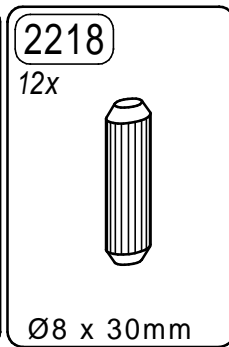
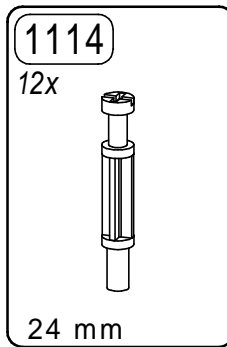

Mod. 1364 **Teileliste** - liste de pièces - partlist

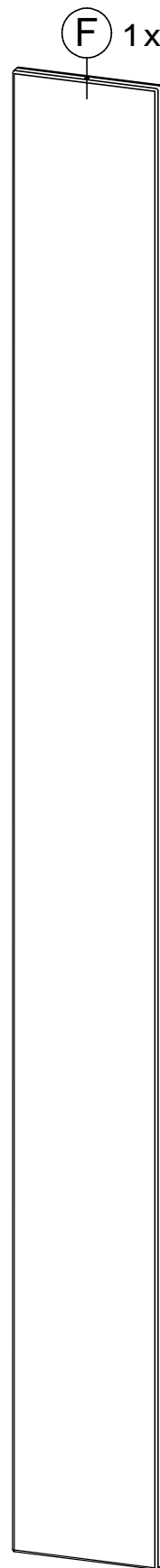
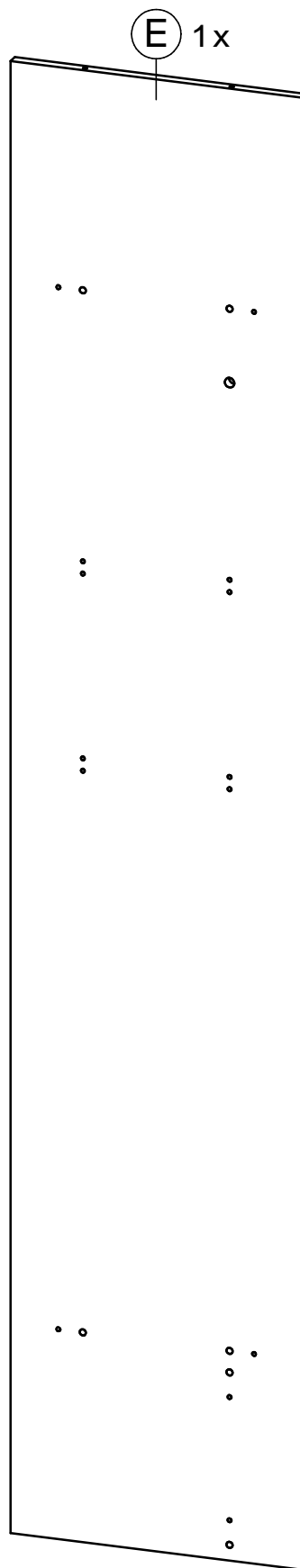
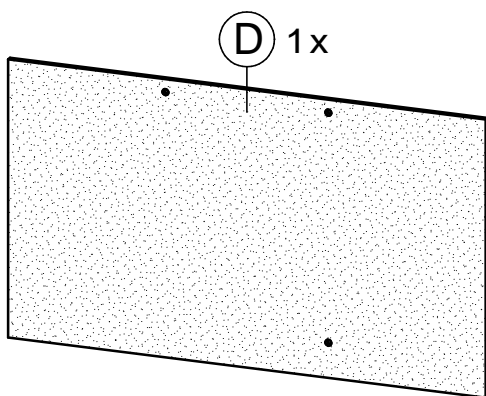
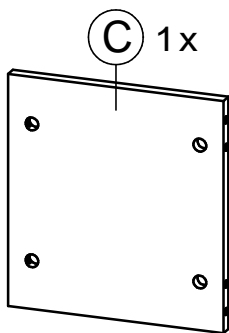
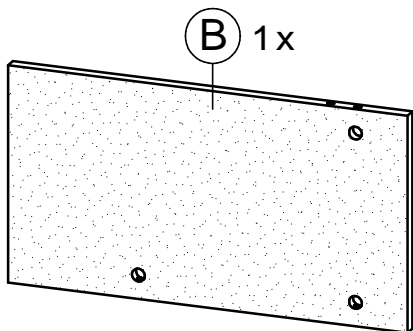
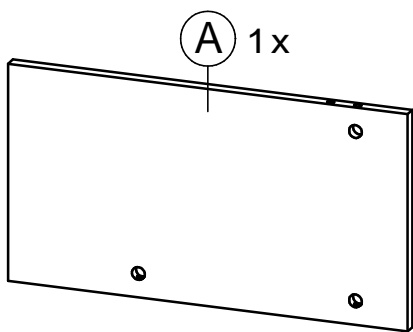

erstellt		geändert		geprüft	
Datum: 15.06.10		Datum:		Datum: 21.06.10	

# Mod. 1364 **Montageschritte** - ordre de montage - assembly instructions

## 1.

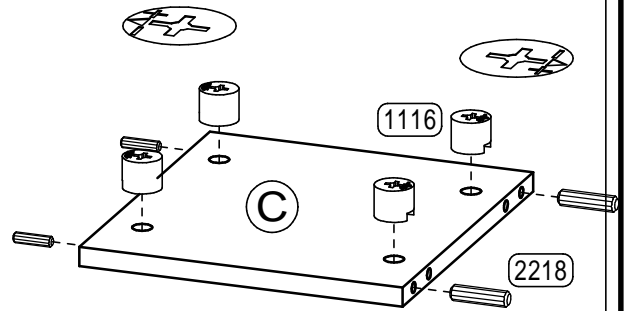
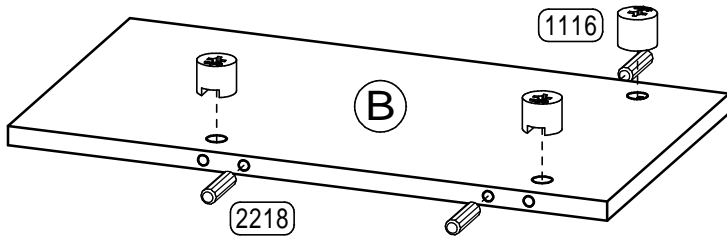
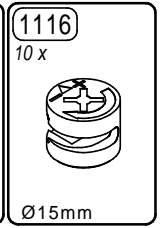
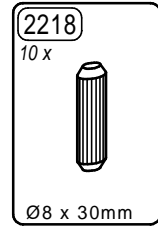
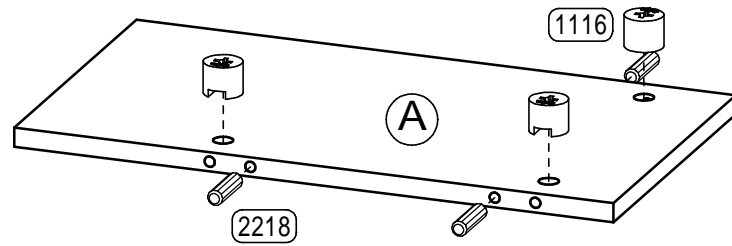

## 2.

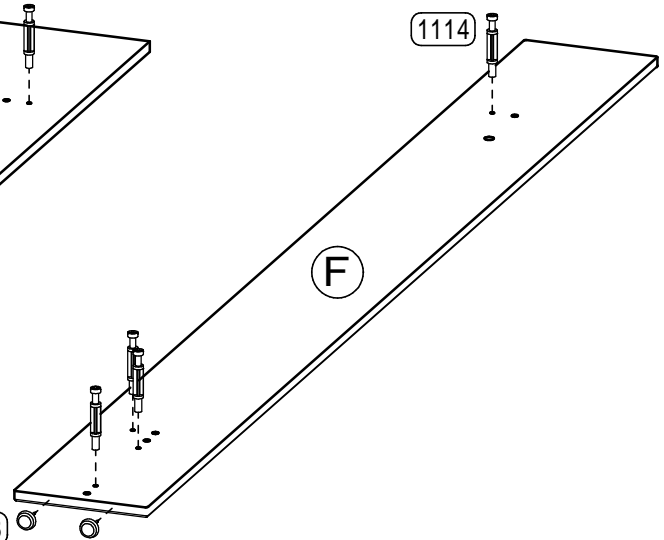
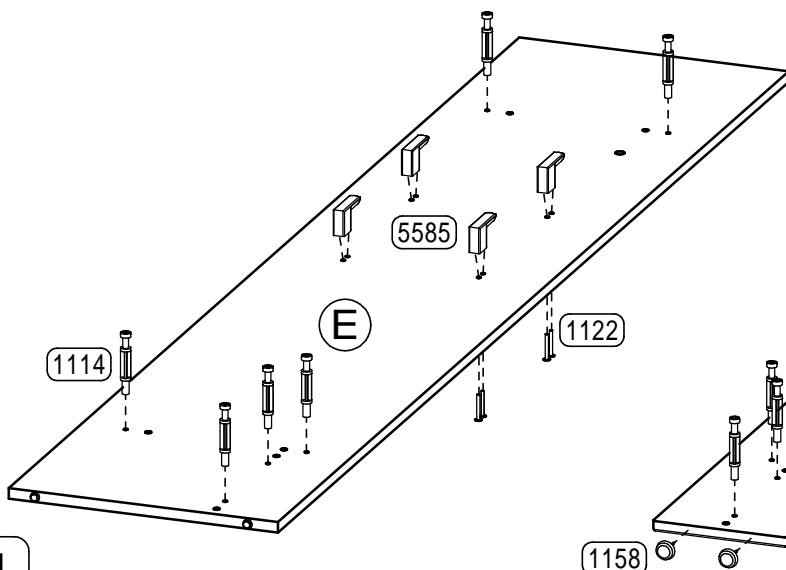
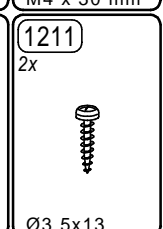
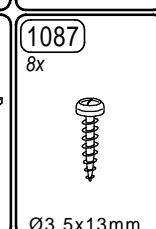
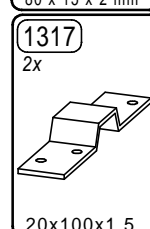
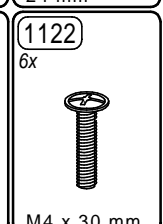
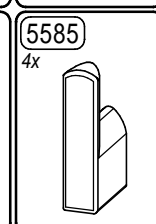
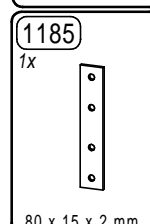
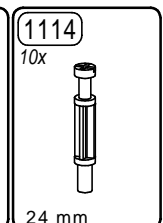
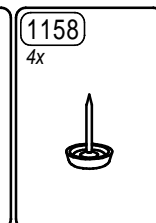
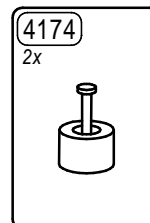
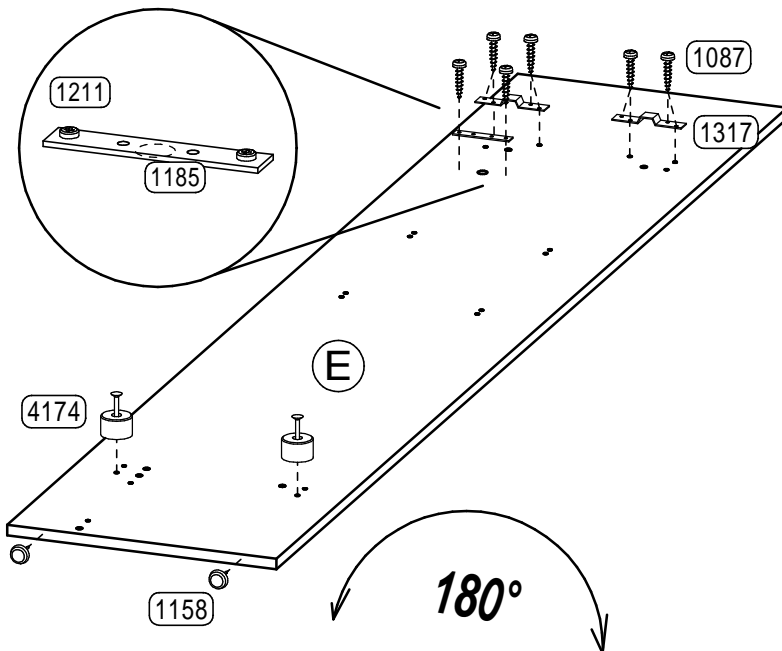

## 4

erstellt	geändert	geprüft
Datum: 15.06.10	Datum:	Datum: 21.06.10

**3.**

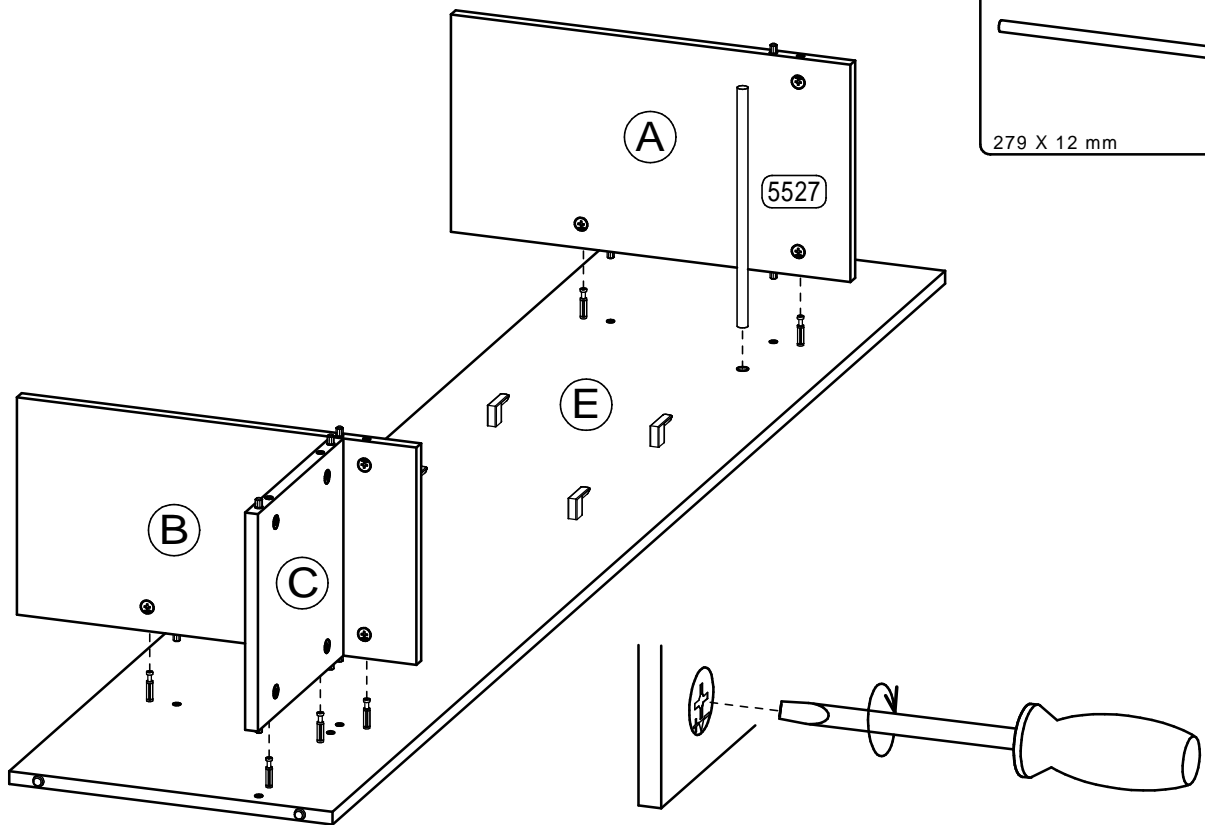

5527  
1x  
279 X 12 mm

**4.**

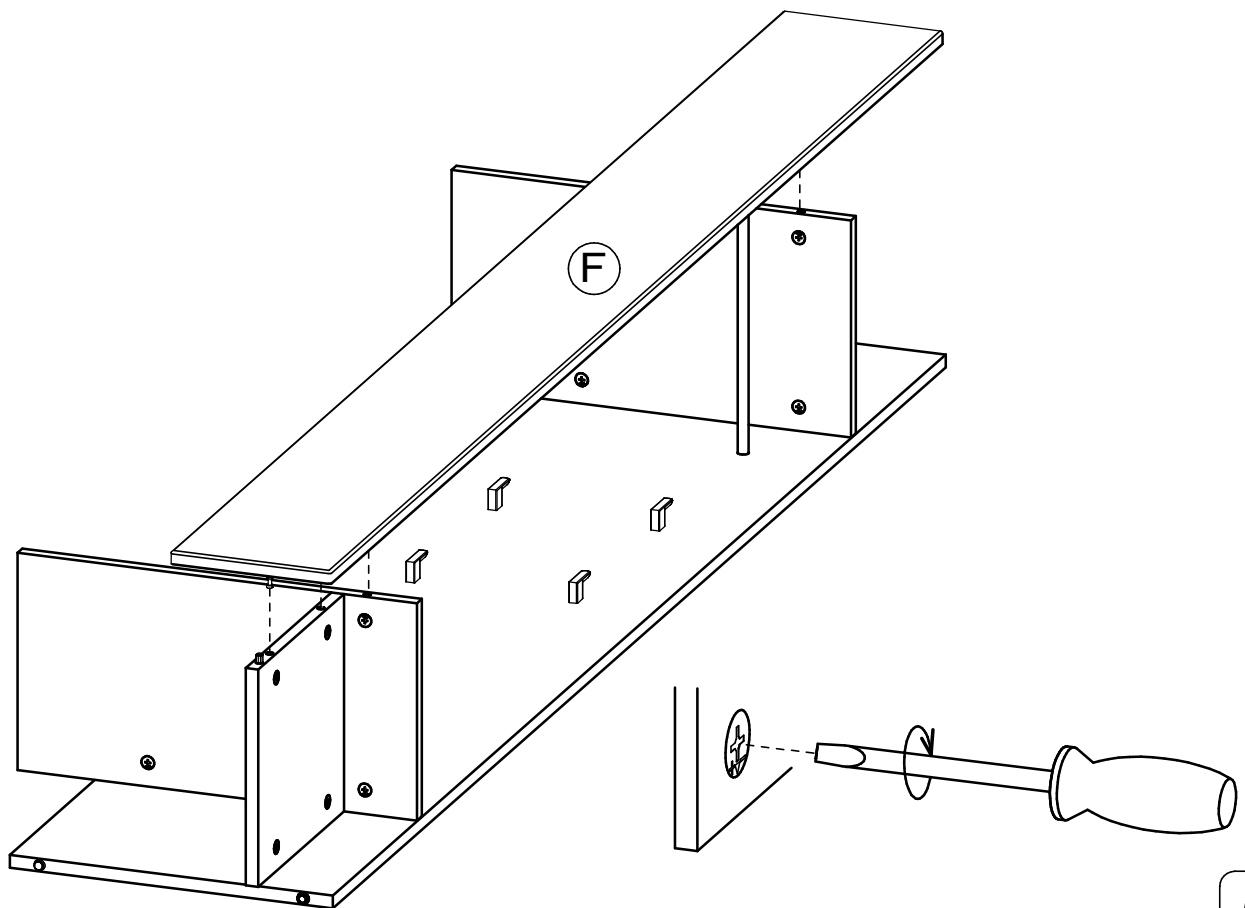

**5**

erstellt		geändert		geprüft	
Datum: 15.06.10		Datum:		Datum: 21.06.10	

**5.**

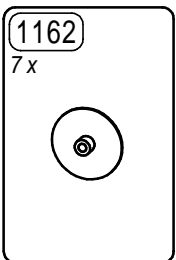
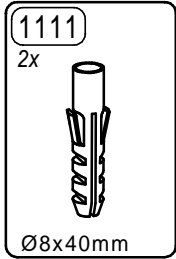
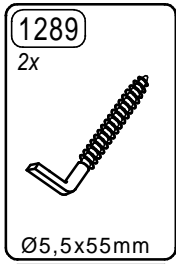
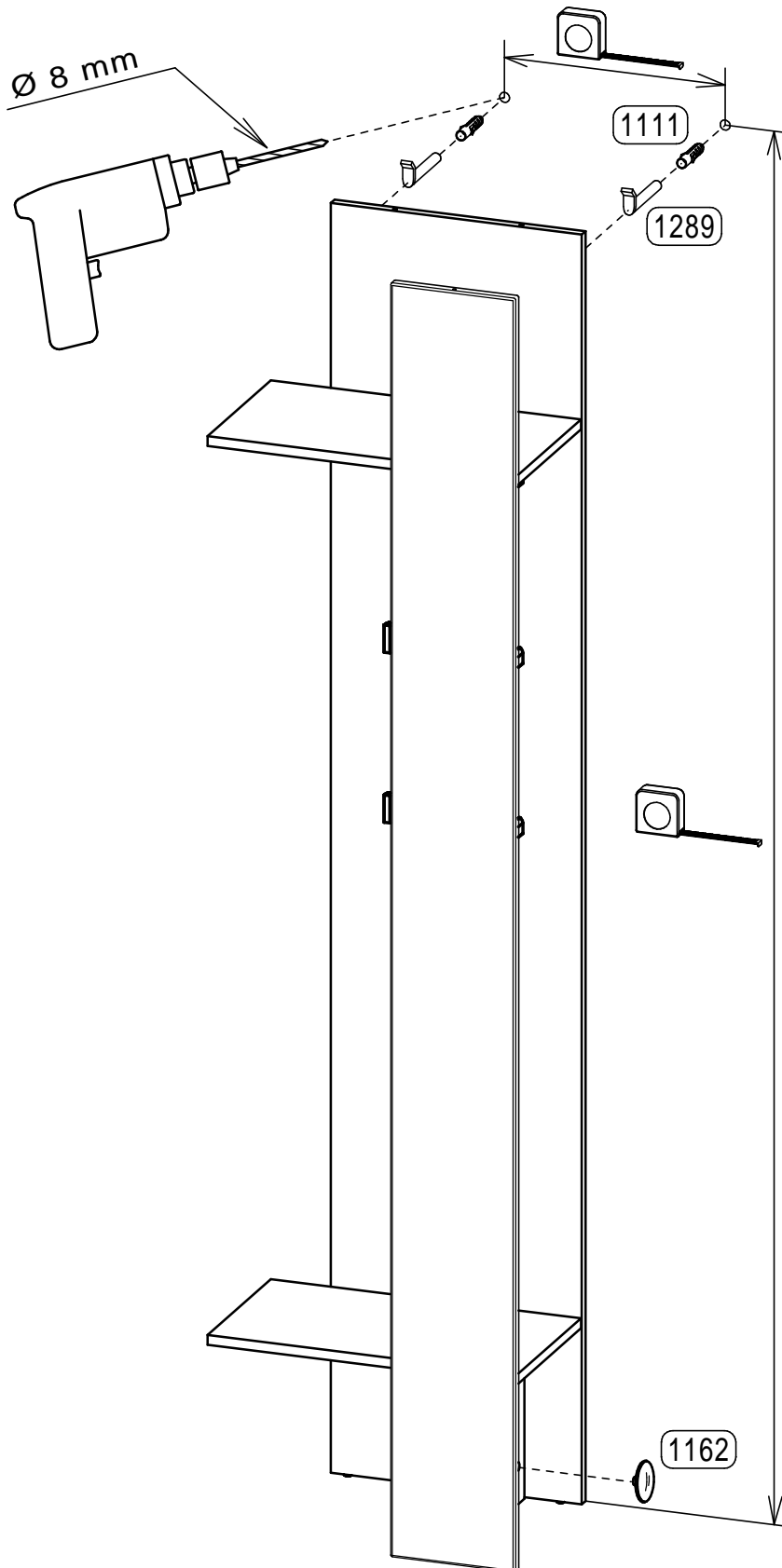

**6**

erstellt		geändert		geprüft	
Datum:	15.06.10	Datum:		Datum:	21.06.10

**6.**

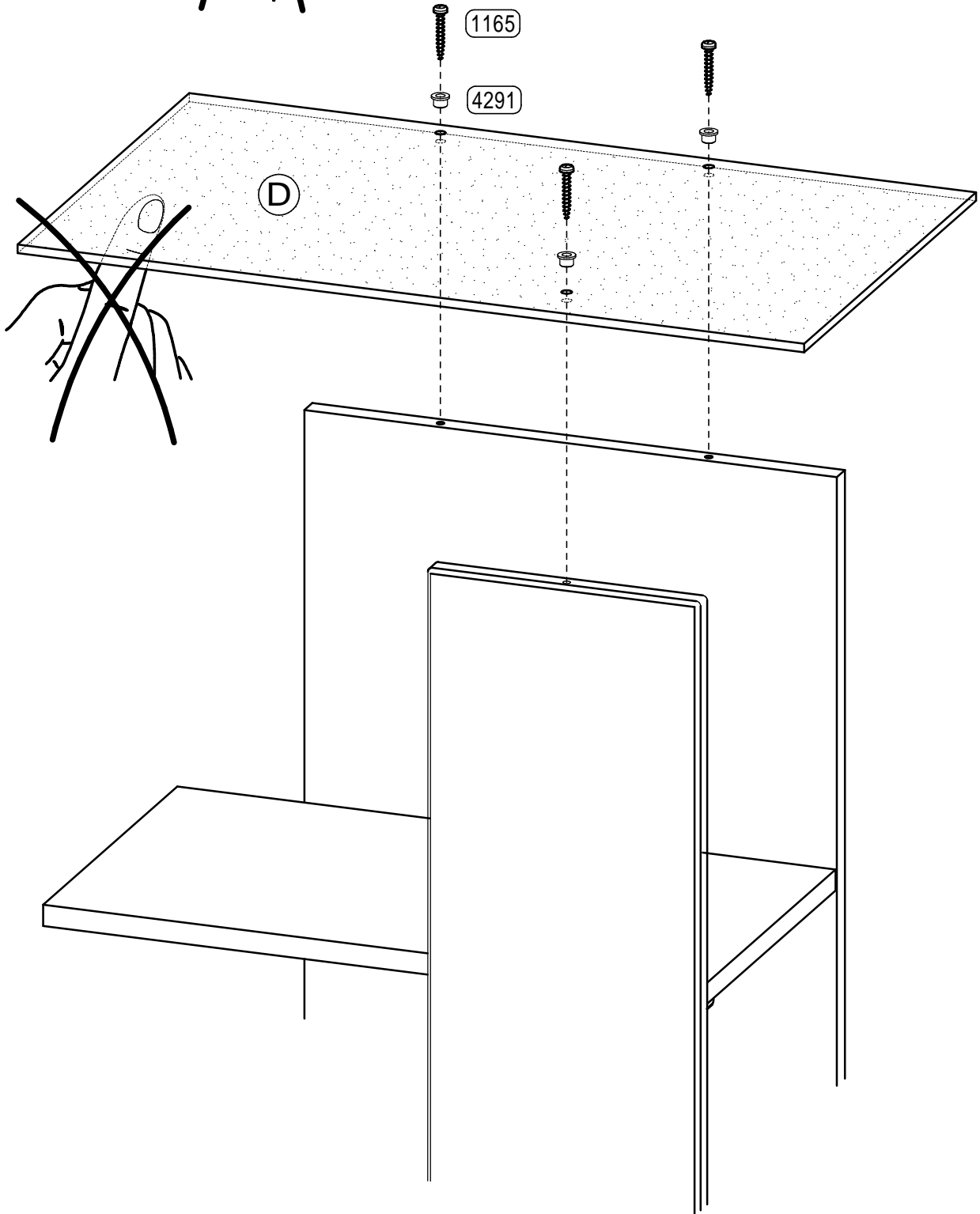
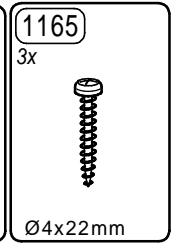
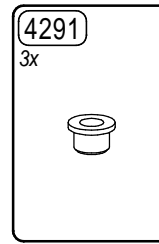
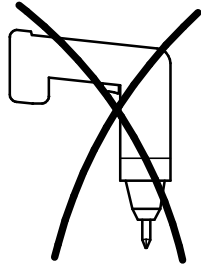

**7**

erstellt	geändert	geprüft
Datum: 15.06.10	Datum:	Datum: 21.06.10

Sehr geehrter Kunde,  
solte ein Möbelteil bzw. Beschlagteil fehlen oder beschädigt sein, senden Sie uns den Artikel bitte **nicht** zurück, sondern fordern Sie der Einfachheit halber Ersatz direkt bei **GERMANIA** an.  
Tragen Sie Ihren Bedarf in die Tabelle ein und übermitteln Sie uns diese Seite per Post, per Fax, telefonisch oder per e-mail.  
Bitte unbedingt die Modellnummer, Dekornummer (siehe Karton) und die entsprechende Teilebezeichnung (siehe Teilleiste) angeben.

Mod. Nr.: ..... Dekor-Nr.: .....

Möbelteile				Beschlagteile			
Teil	beschäd. *	fehlt *	Anzahl	Teil	beschäd. *	fehlt *	Anzahl
Z	X		1	9137		X	2

\* beschädigt oder fehlt bitte ankreuzen

Absender nicht vergessen :

Name:	Strasse u. Nr.:
PLZ:	Ort :
Tel.:	Fax: e-mail:

Unsere Hotline :

Tel. 05252 84939 und 05252 84962 Fax: 05252 84936

e-mail : service@mygermania.com

**GERMANIA** - Service - Postfach 1160 D 33189 Schlangen

## Sicherheitshinweise

### Safety instructions

### Indications de sécurité

**GERMANIA**  
the furniture factory

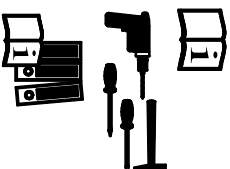

- 1.) Montageanleitung aufmerksam durchlesen  
Please read assembly instruction carefully  
Prière de bien lire la notice de montage du début à la fin
- 2.) Montage nach Montageanleitung durchführen  
Please follow the assembly instruction step by step  
Bien suivre le sens du montage indiqué sur la notice
- 3.) Montageanleitung aufbewahren  
Please save the assembly instruction  
Bien conserver la notice de montage



**ACHTUNG!** Beschlagbeutel und Beschlagteile von Sauglingen und Kindern fernhalten  
**ATTENTION!** To avoid suffocation keep plastic bag away from children  
**ATTENTION!** Contain small parts which may be a choking hazard  
Toutes les pièces détachées livrées dans le colis être mis hors de portée des bébés des et enfants

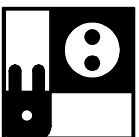
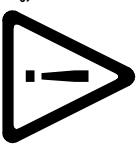

Netzanschluss (230V) nur von einem Fachmann ausführen lassen.  
Sanitäranschluss nur von einem Fachmann ausführen lassen.  
Mains connection (230V) has to be done by an expert.  
Sanitary installation has to be done by an expert.  
L'électricité (230V) uniquement à faire par un électricien.  
Installation sanitaire à faire par un spécialiste.

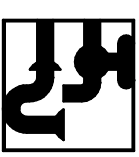

Beiliegendes Befestigungsmaterial eignet sich nur für Massivwände.  
Für andere Wände müssen Spezialdübel verwendet werden.  
Die Festigkeit ist zu Prüfen.  
The attached fixing materials is only suitable for solid walls.  
For other Types of walls special dowels have to be used.  
The firmness have to be checked.  
Le matériel de fixation ci-joint est exclusivement prévu pour des murs pleins (une fixation spéciale est nécessaire pour cloisons placo,...).  
La fermeté est à examiner.

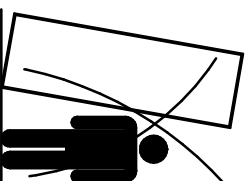

Beiliegende Wandbefestigungen dienen als Kipperschutz,  
unbedingt anbringen!  
The attached wall fixing is necessary to avoid tipping  
and must be fixed!  
Les fixations prévues dans le colis  
préviennent contre le renversement du  
meuble. Il faut impérativement fixer le  
meuble au mur, afin d'éviter tout incident!

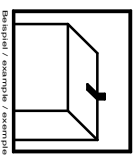

Beiliegendes Befestigungsmaterial eignet sich nur für Massivwände.  
Für andere Wände müssen Spezialdübel verwendet werden.  
Die Festigkeit ist zu Prüfen.  
The attached fixing materials is only suitable for solid walls.  
For other Types of walls special dowels have to be used.  
The firmness have to be checked.  
Le matériel de fixation ci-joint est exclusivement prévu pour des murs pleins (une fixation spéciale est nécessaire pour cloisons placo,...).  
La fermeté est à examiner.

Für Schäden, die durch unsachgemäße Montage entstanden sind, übernehmen wir keine Haftung  
For the damages, which have originated from improper assembly, we take over no liability.  
Pour les dommages qui sont nés par le montage incorrect, nous ne prenons en charge aucune responsabilité.