

STOLIK 1000x680x410

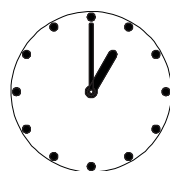

60 min

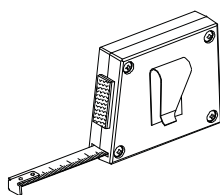

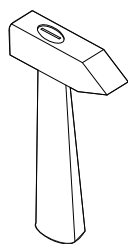
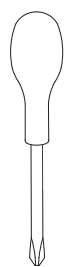
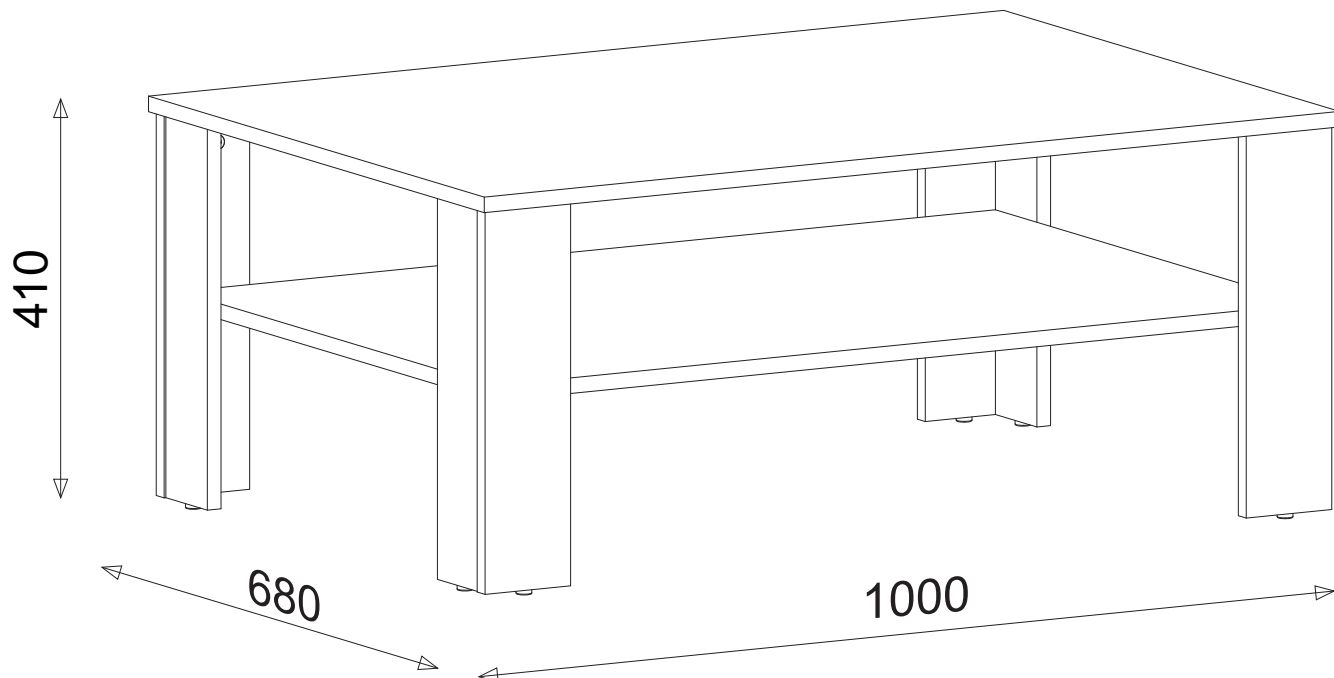
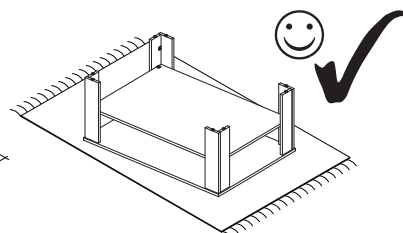
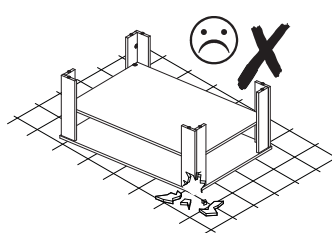
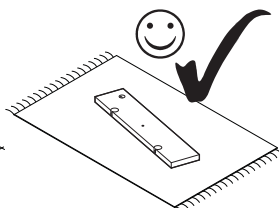
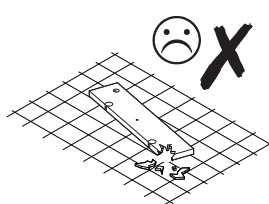
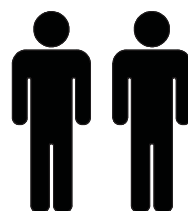
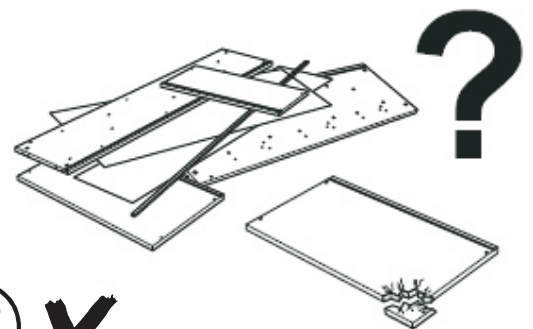
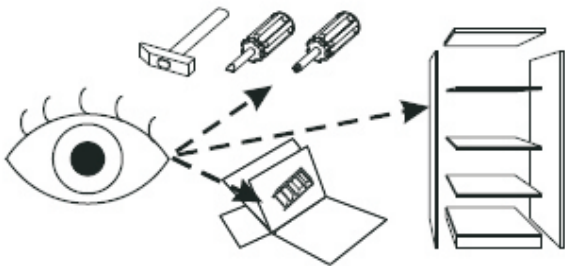
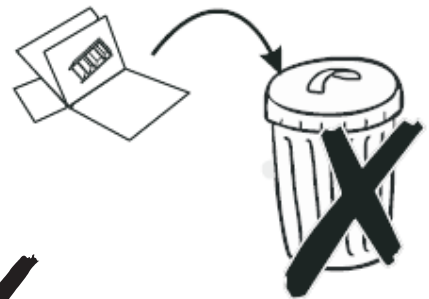
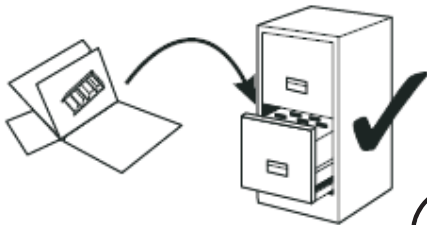
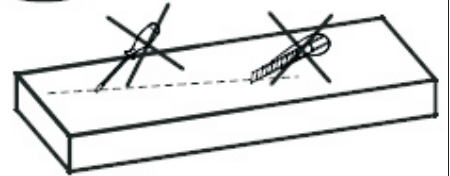
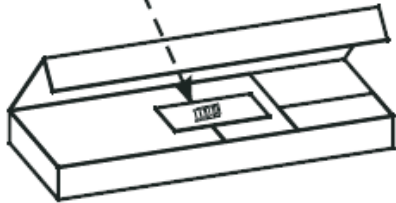
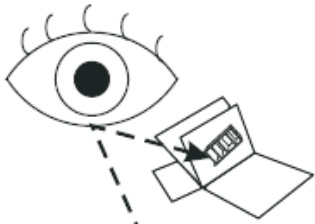

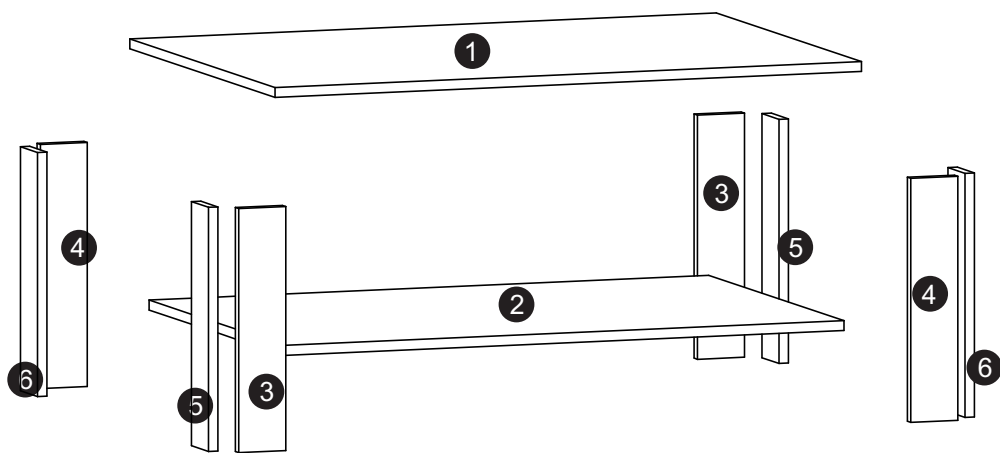

NUMER ELEMENTU	DŁUGOŚĆ	SZEROKOŚĆ	GUBOŚĆ	ILOŚĆ
1	1000	680	16	1
2	953	634	16	1
3	394	84	16	2
4	394	84	16	2
5	394	100	16	2
6	394	100	16	2

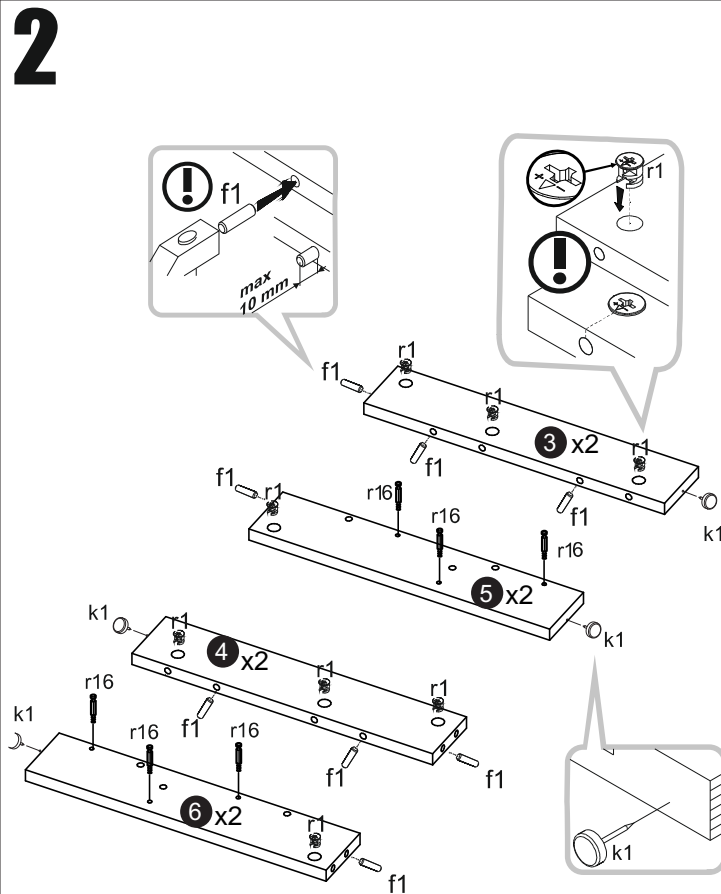
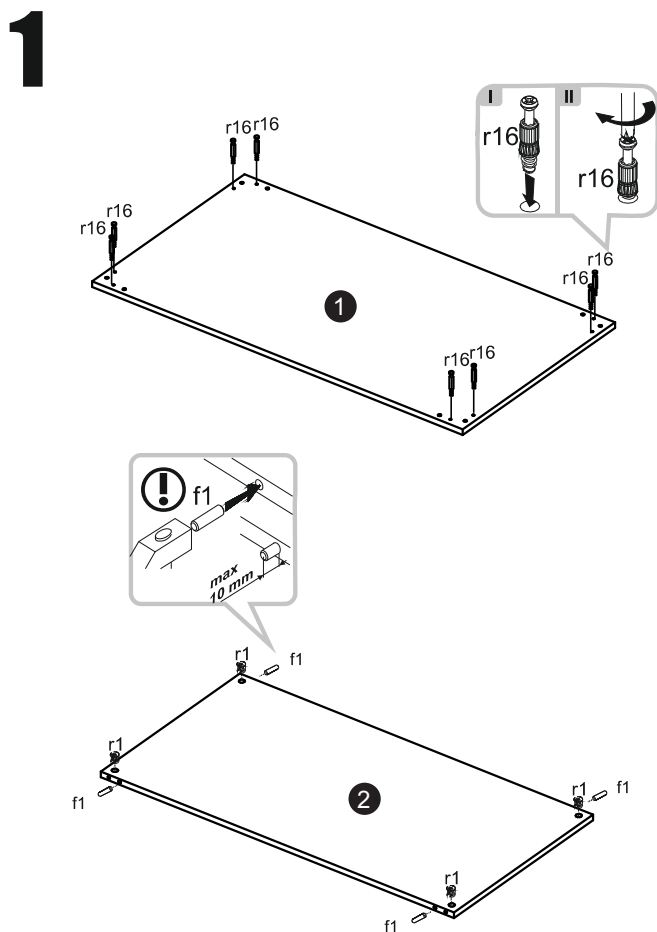
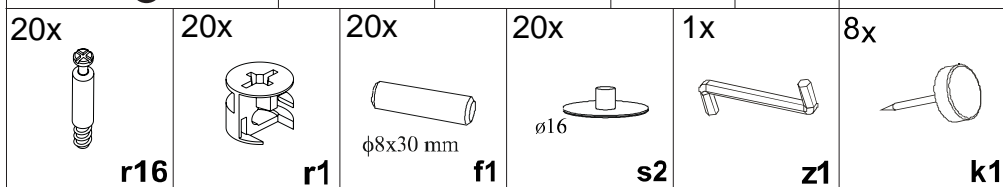

3

