

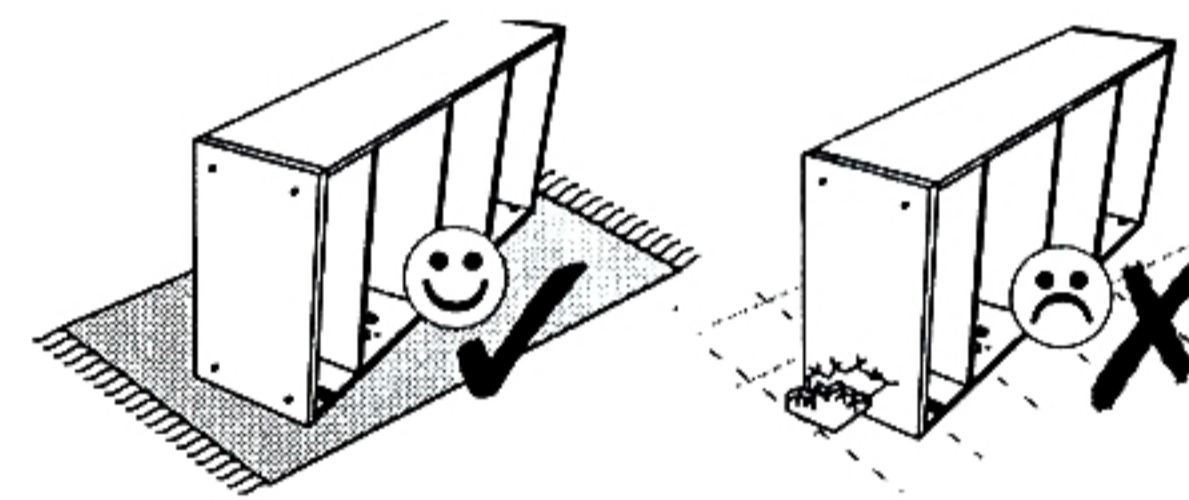

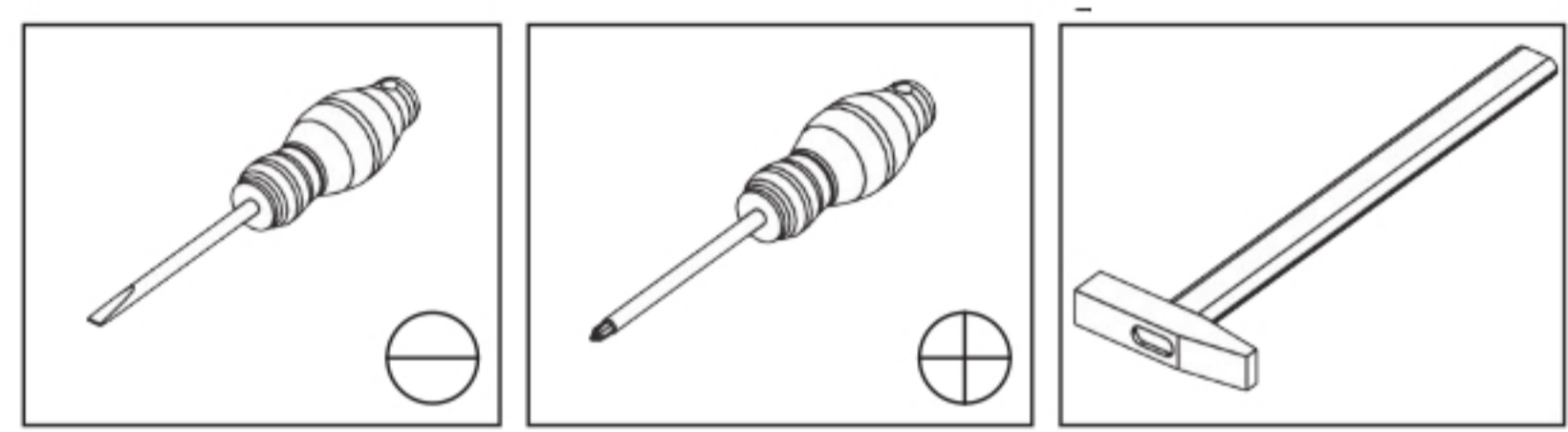

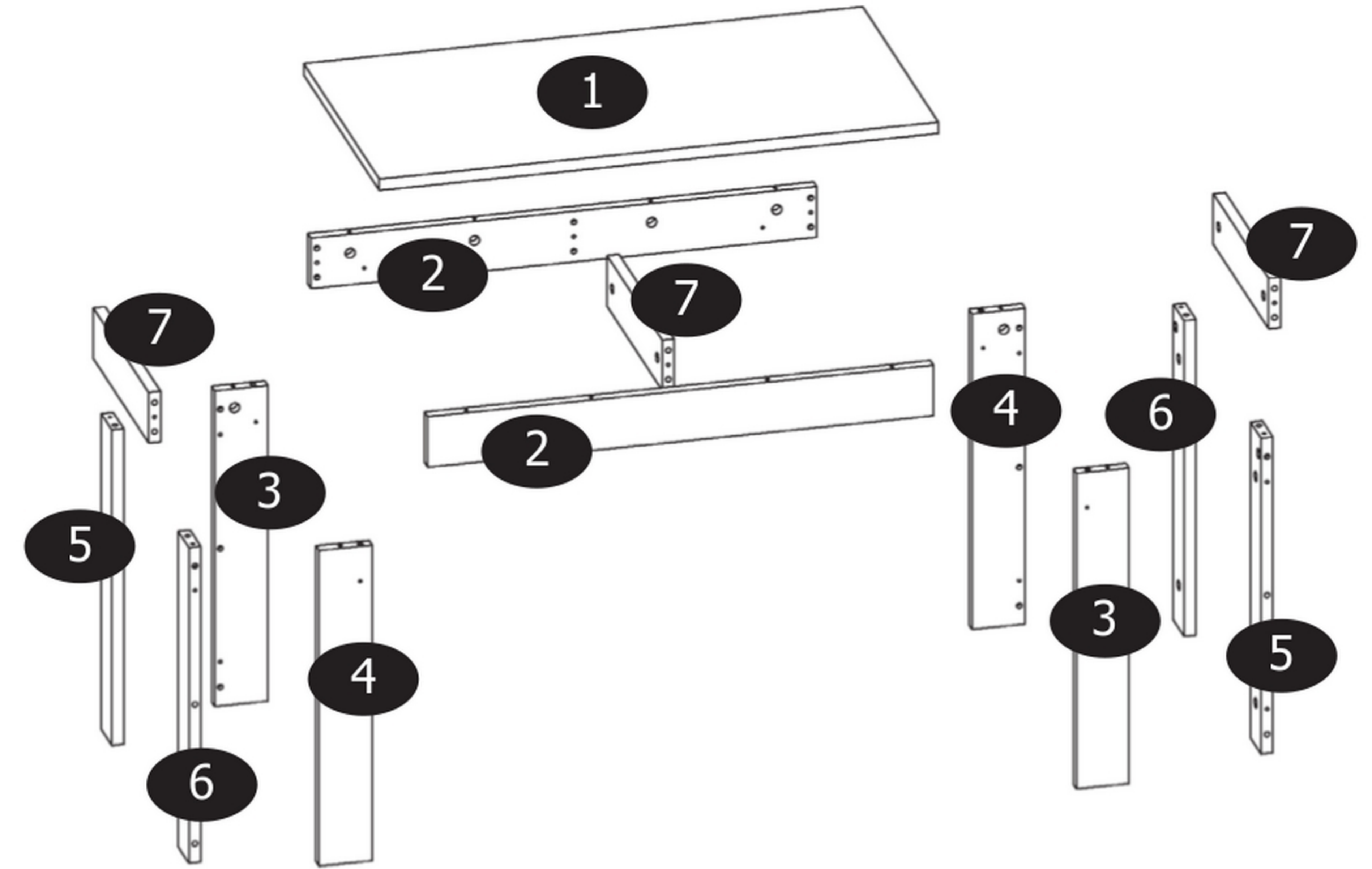

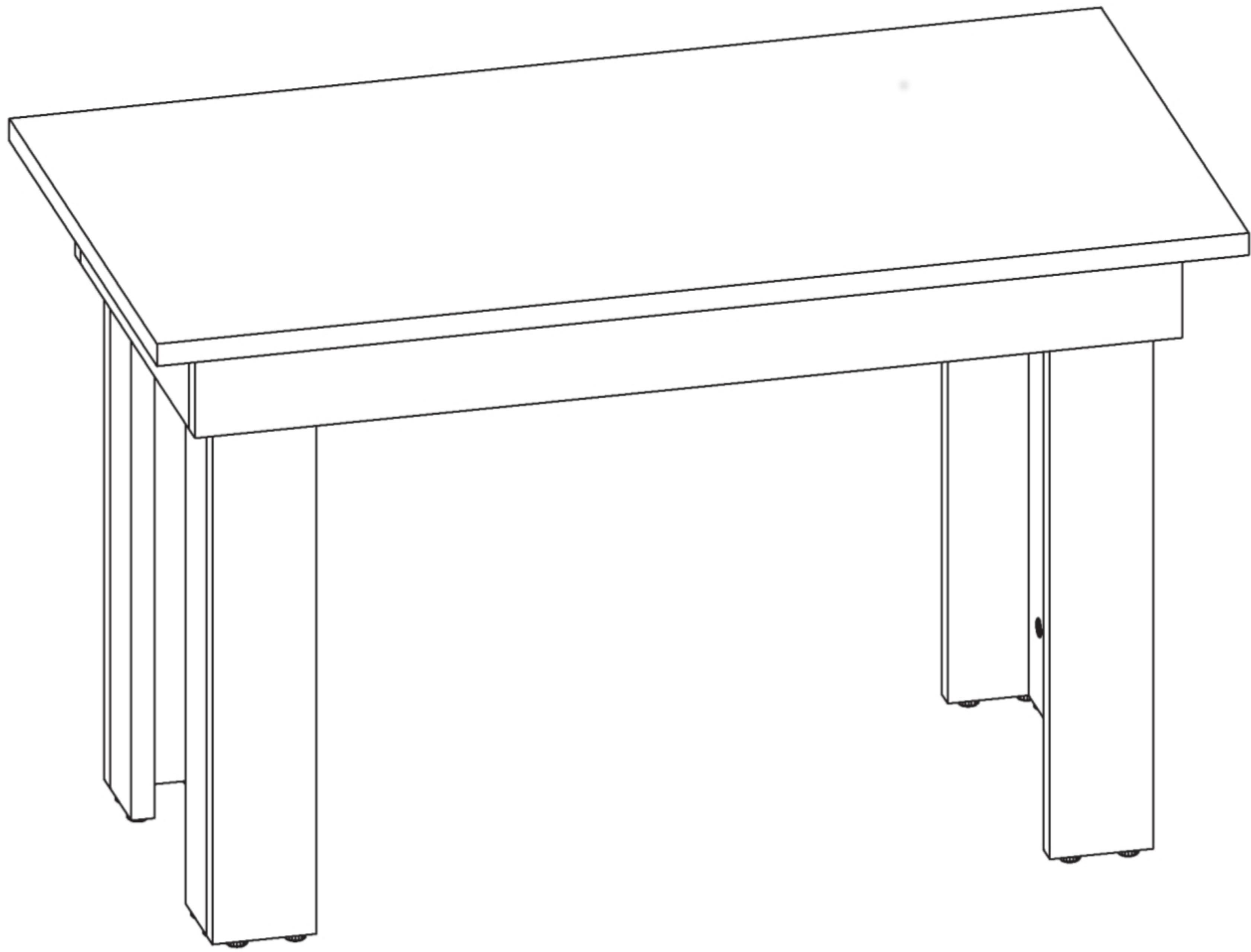

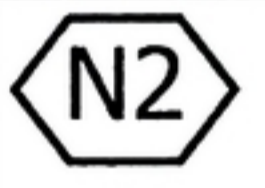
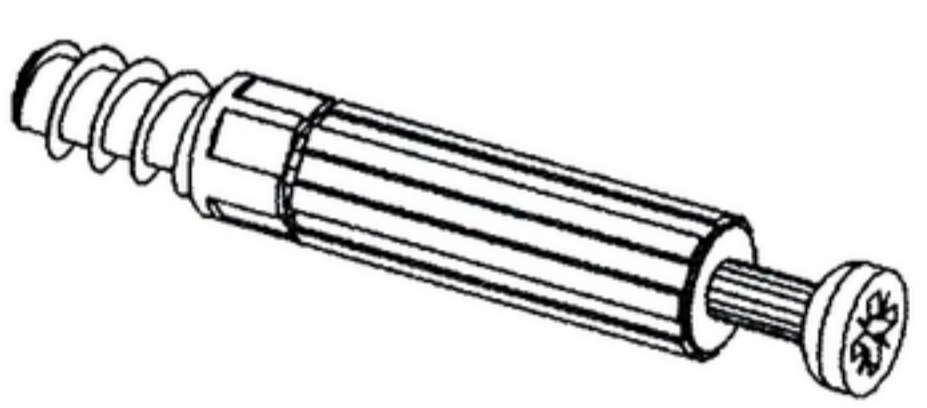

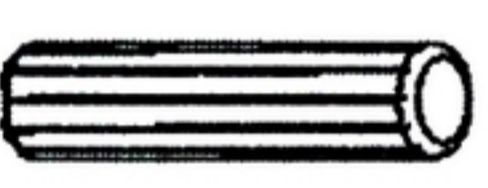

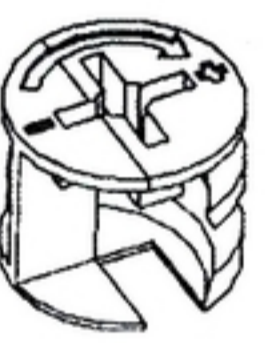

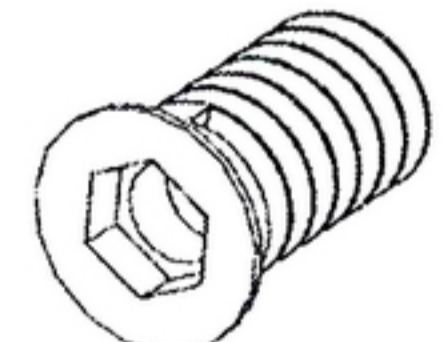
# MADRAS

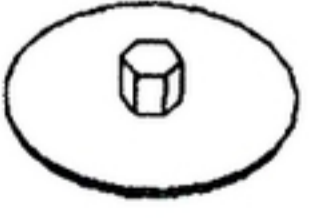

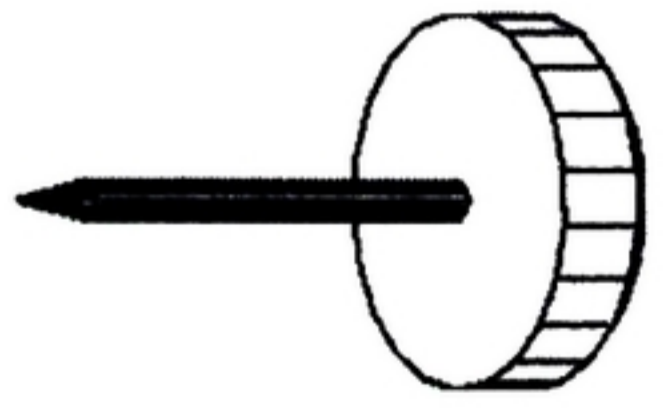
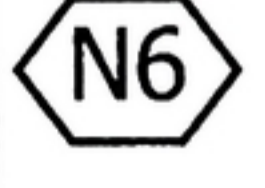
- 1 x 1
- 2 x 2
- 3 x 2
- 4 x 2
- 5 x 2
- 6 x 2
- 7 x 3

|   |  |  |
|---|--|--|
|  <br><b>x 30</b> |  <br><b>x 32</b> |  <br><b>x 30</b> |
|  <br><b>x 4</b>  |  <br><b>x 18</b> |  <br><b>x 16</b> |
|  <br><b>x 4</b>  |  <br><b>x 1</b>  |  |

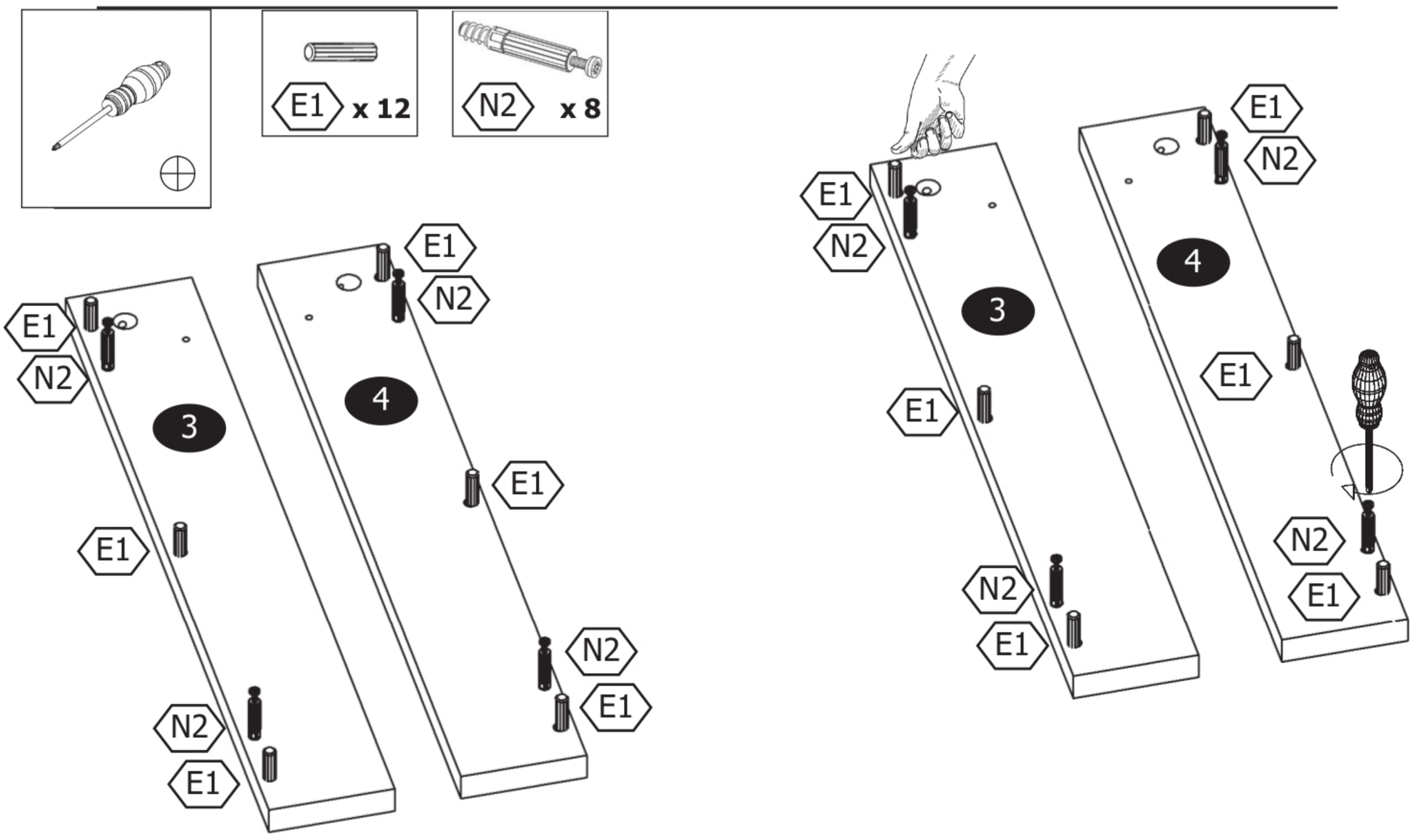
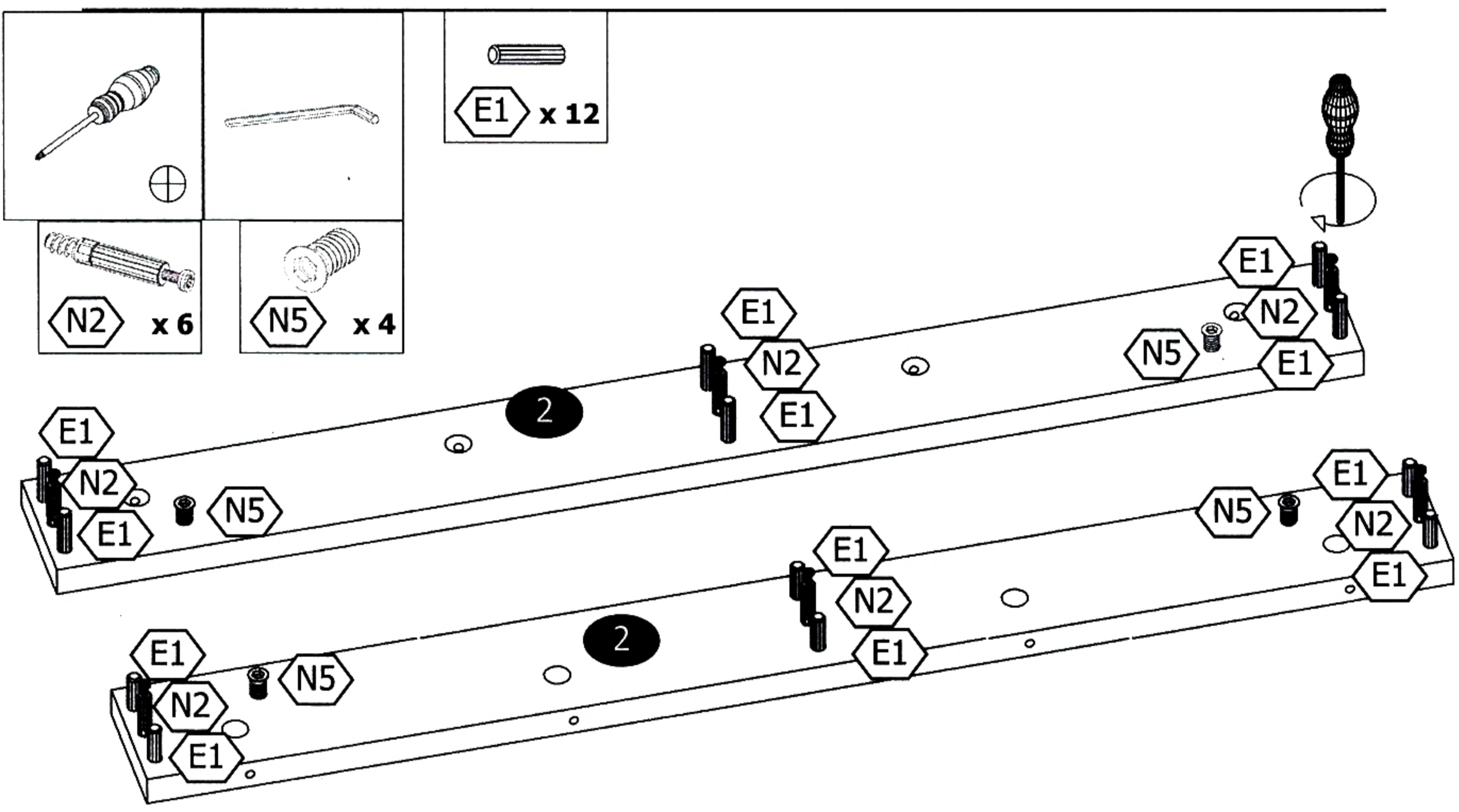
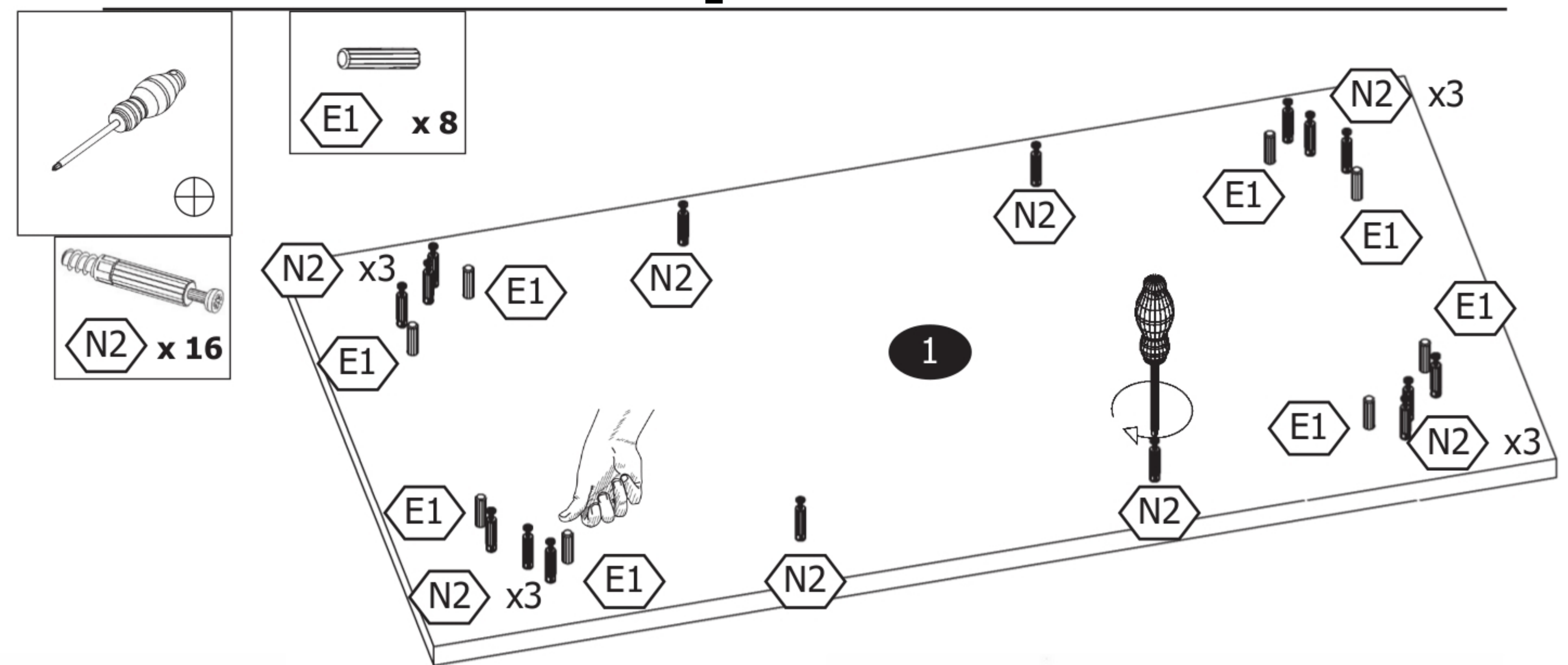
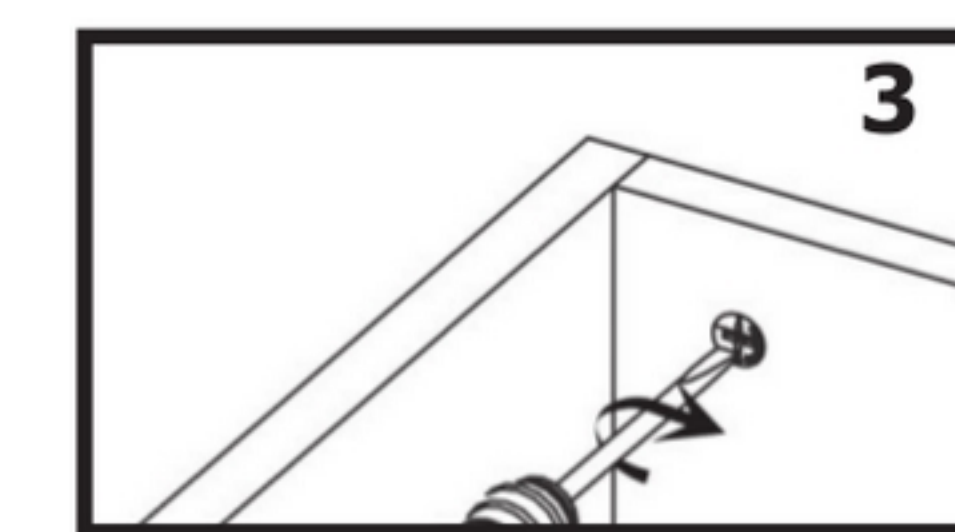
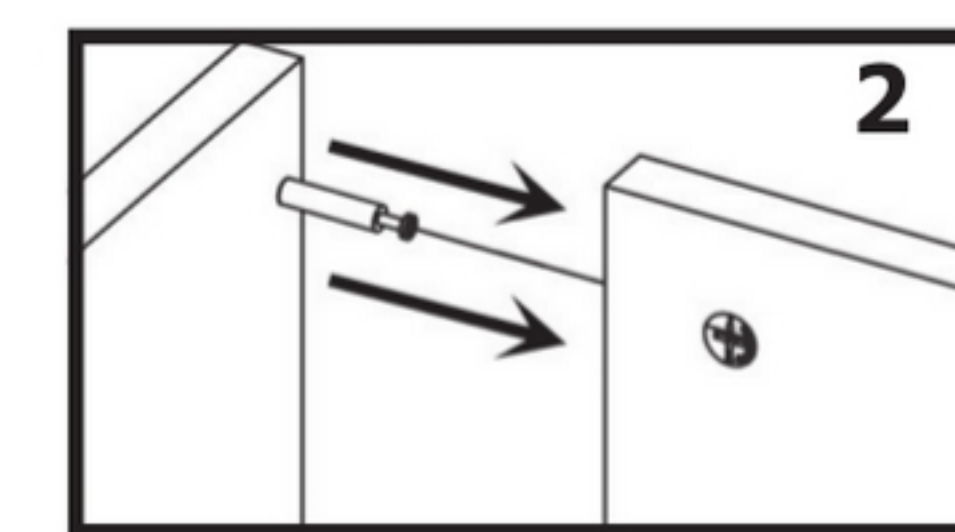
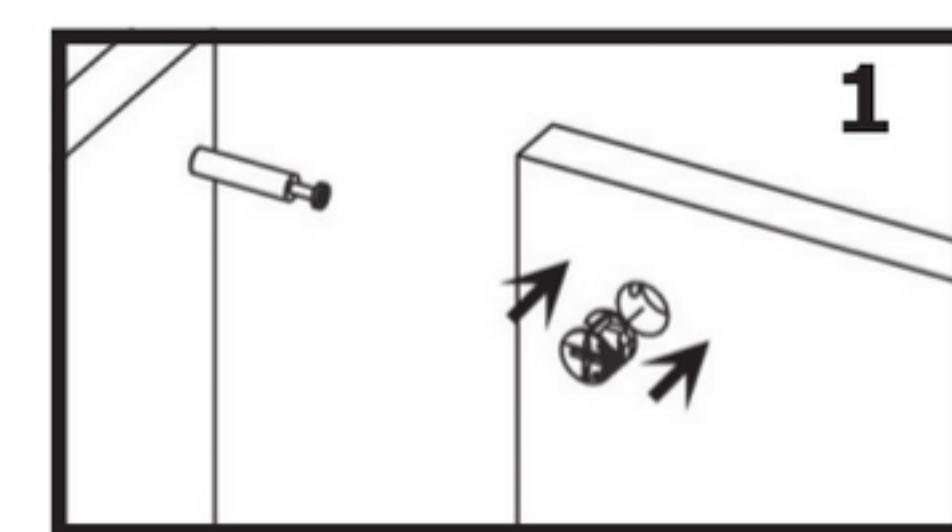
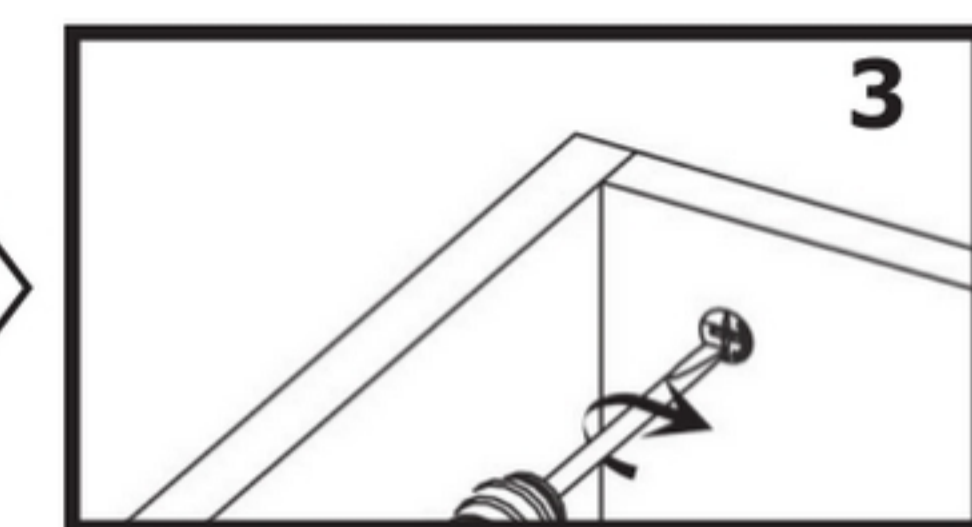
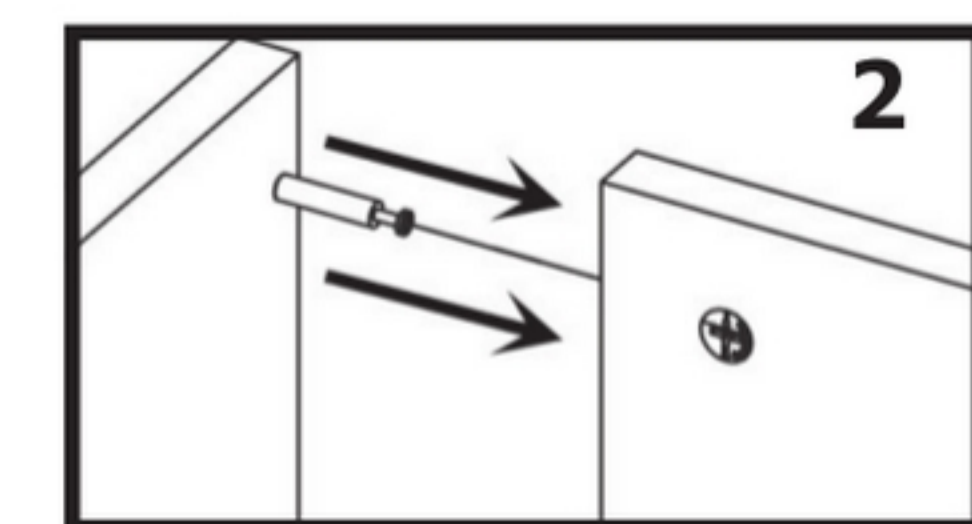
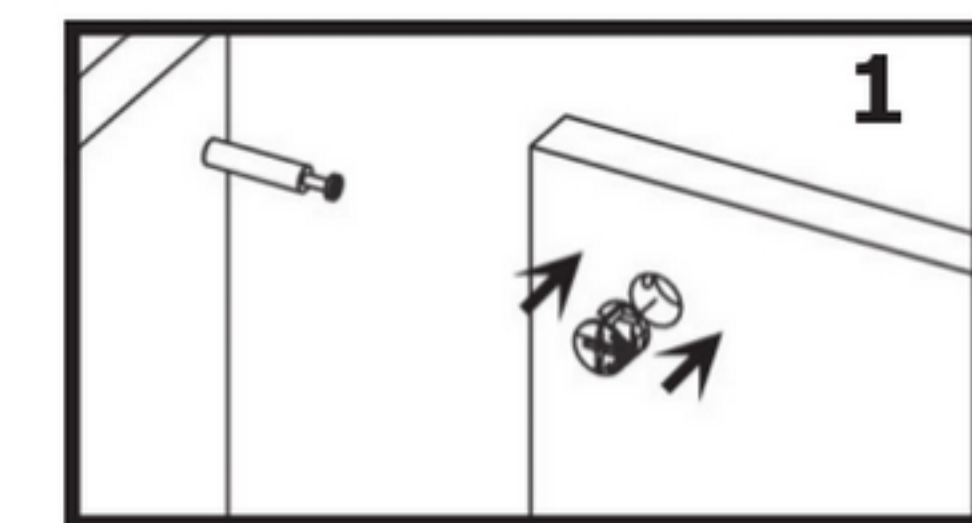
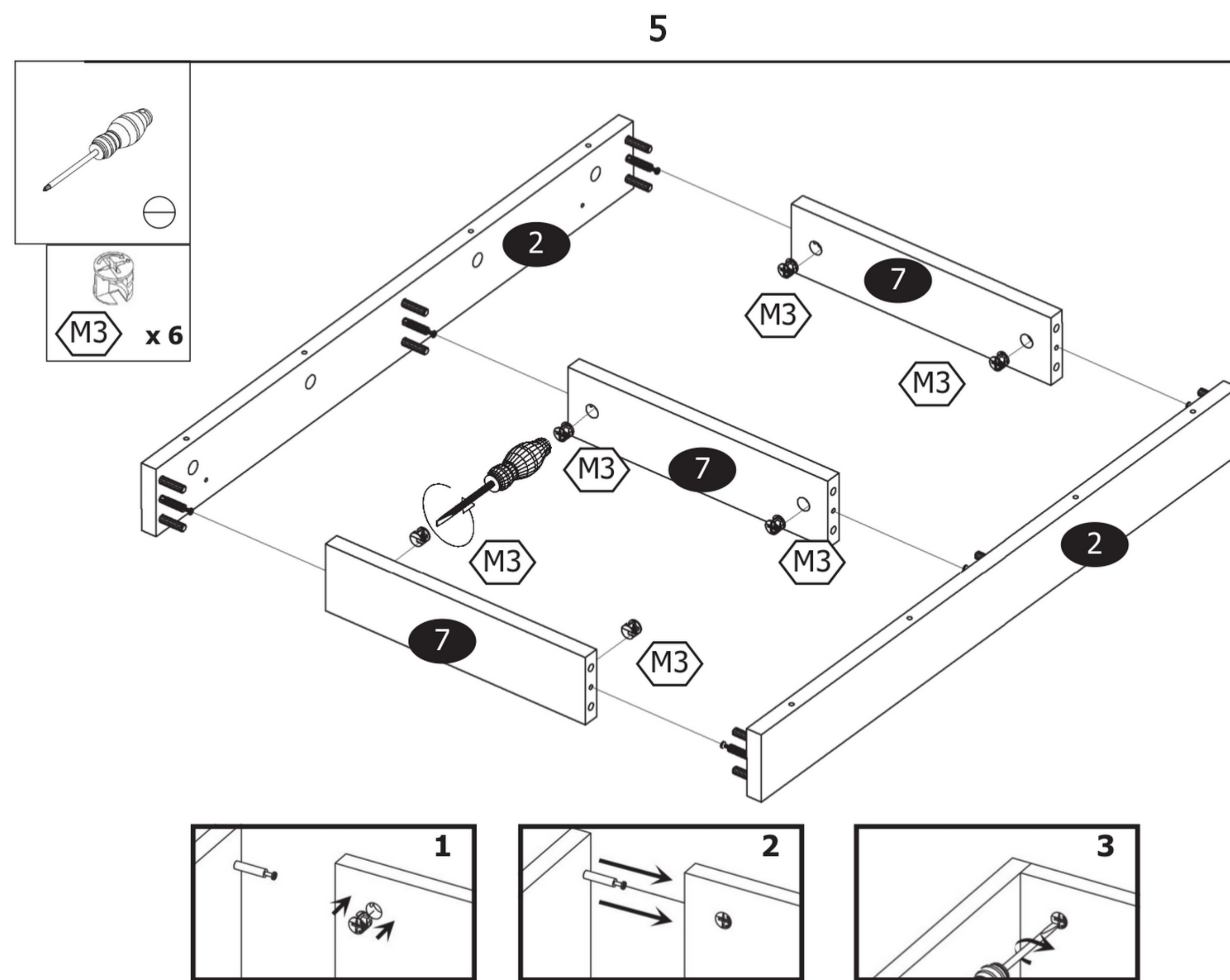
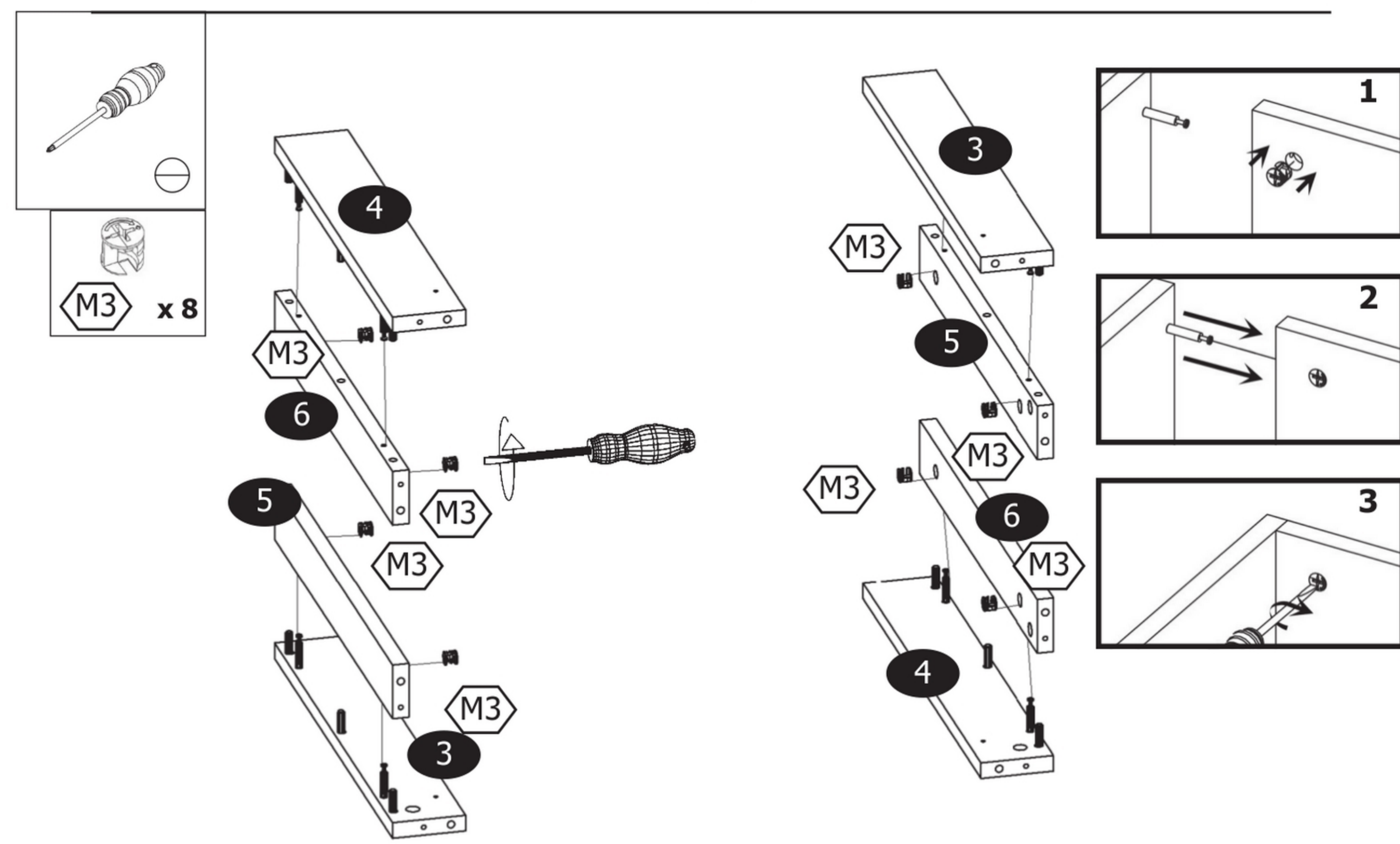
**1****2**

# 3

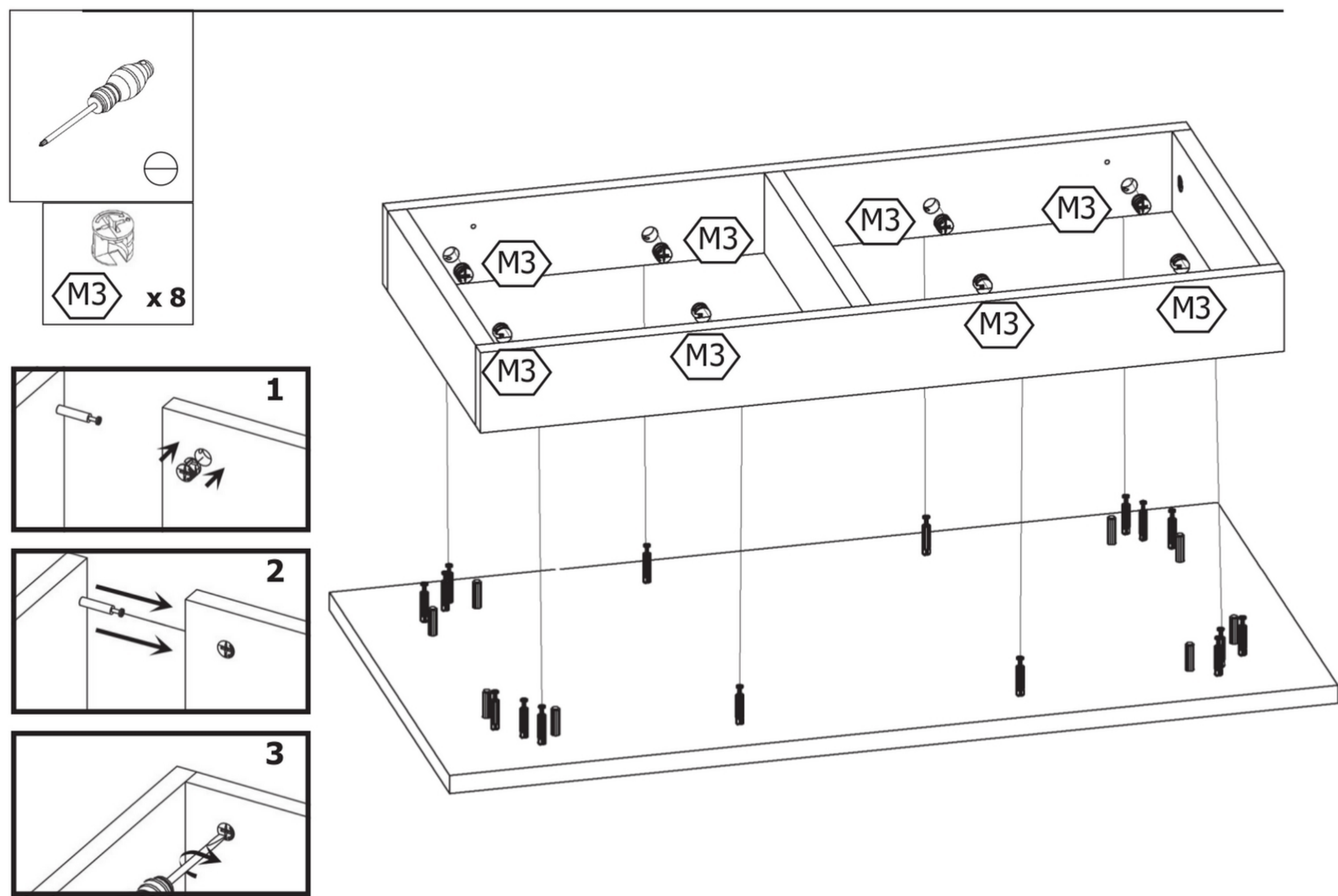

# 4

