

# ANGEL

## AWT119

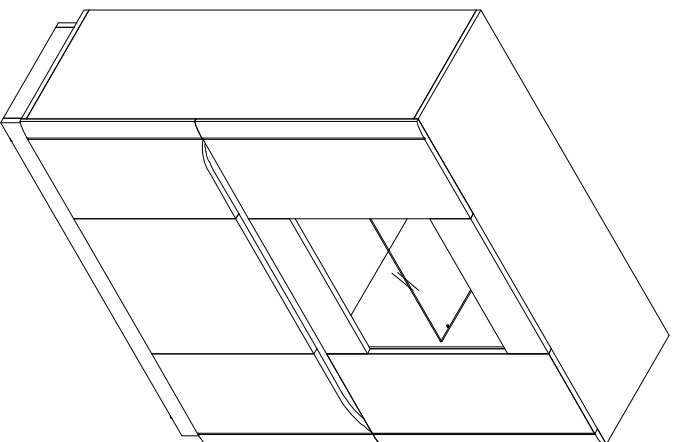

27.3.2018

- D** Montageanleitung
- FR** Notice de montage
- NL** Handleiding voor de montage
- CZ** Montážní návod
- HU** Szerelési útmutató
- TR** Montaj talimatı
- GB** Assembly Instructions
- IT** Istruzioni di montaggio
- PL** Instrukcja montażu
- SK** Návod na montáž
- RO** Instrucțiunile de montaj
- RU** Инструкции по монтажу

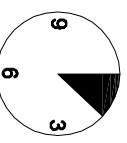

20 min.

1

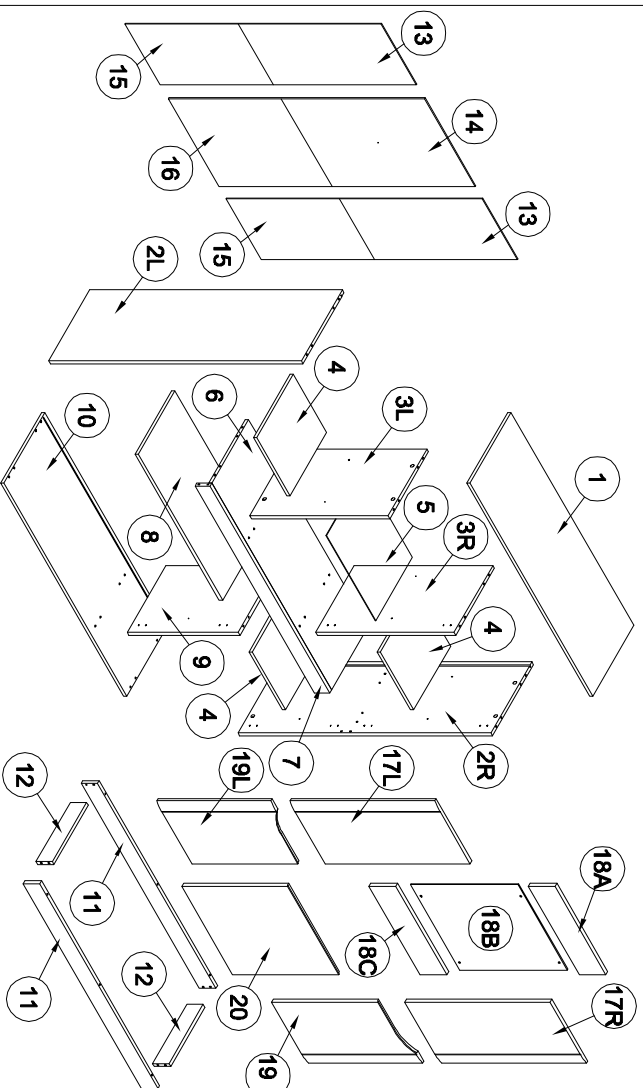

<b>ZA</b> X1 Bx32	<b>H</b> X24 6.3x13	<b>TB</b> X1 Screw	<b>TA</b> X1 Bracket	<b>ZE</b> X4 Washer	<b>Z</b> X16 Screw	<b>ZC</b> X25 Washer	<b>SLZ</b> X6 Washer	<b>X</b> X20 Screw
<b>A</b> X42 Screw	<b>B</b> X24 Screw	<b>RC</b> X4 Bracket	<b>RC</b> X4 Bracket	<b>GLUE</b> X1 Glue	<b>PB</b> X4 Screw	<b>ND</b> X25 Screw	<b>ZD</b> X4 Washer	<b>NC</b> X4 Screw
<b>RC</b> X8 Bracket	<b>RC</b> X4 Bracket	<b>ZE</b> X4 Washer	<b>Z</b> X16 Screw	<b>PC</b> X8 Screw	<b>ND</b> X25 Screw	<b>ZD</b> X4 Washer	<b>NC</b> X4 Screw	<b>S</b> X1 L-576mm
<b>ZA</b> X1 Bx32	<b>H</b> X24 6.3x13	<b>TB</b> X1 Screw	<b>TA</b> X1 Bracket	<b>ZE</b> X4 Washer	<b>Z</b> X16 Screw	<b>ZC</b> X25 Washer	<b>SLZ</b> X6 Washer	<b>X</b> X20 Screw
<b>A</b> X42 Screw	<b>B</b> X24 Screw	<b>RC</b> X4 Bracket	<b>RC</b> X4 Bracket	<b>GLUE</b> X1 Glue	<b>PB</b> X4 Screw	<b>ND</b> X25 Screw	<b>ZD</b> X4 Washer	<b>NC</b> X4 Screw
<b>RC</b> X8 Bracket	<b>RC</b> X4 Bracket	<b>ZE</b> X4 Washer	<b>Z</b> X16 Screw	<b>PC</b> X8 Screw	<b>ND</b> X25 Screw	<b>ZD</b> X4 Washer	<b>NC</b> X4 Screw	<b>S</b> X1 L-576mm
<b>ZA</b> X1 Bx32	<b>H</b> X24 6.3x13	<b>TB</b> X1 Screw	<b>TA</b> X1 Bracket	<b>ZE</b> X4 Washer	<b>Z</b> X16 Screw	<b>ZC</b> X25 Washer	<b>SLZ</b> X6 Washer	<b>X</b> X20 Screw
<b>A</b> X42 Screw	<b>B</b> X24 Screw	<b>RC</b> X4 Bracket	<b>RC</b> X4 Bracket	<b>GLUE</b> X1 Glue	<b>PB</b> X4 Screw	<b>ND</b> X25 Screw	<b>ZD</b> X4 Washer	<b>NC</b> X4 Screw
<b>RC</b> X8 Bracket	<b>RC</b> X4 Bracket	<b>ZE</b> X4 Washer	<b>Z</b> X16 Screw	<b>PC</b> X8 Screw	<b>ND</b> X25 Screw	<b>ZD</b> X4 Washer	<b>NC</b> X4 Screw	<b>S</b> X1 L-576mm
<b>ZA</b> X1 Bx32	<b>H</b> X24 6.3x13	<b>TB</b> X1 Screw	<b>TA</b> X1 Bracket	<b>ZE</b> X4 Washer	<b>Z</b> X16 Screw	<b>ZC</b> X25 Washer	<b>SLZ</b> X6 Washer	<b>X</b> X20 Screw
<b>A</b> X42 Screw	<b>B</b> X24 Screw	<b>RC</b> X4 Bracket	<b>RC</b> X4 Bracket	<b>GLUE</b> X1 Glue	<b>PB</b> X4 Screw	<b>ND</b> X25 Screw	<b>ZD</b> X4 Washer	<b>NC</b> X4 Screw
<b>RC</b> X8 Bracket	<b>RC</b> X4 Bracket	<b>ZE</b> X4 Washer	<b>Z</b> X16 Screw	<b>PC</b> X8 Screw	<b>ND</b> X25 Screw	<b>ZD</b> X4 Washer	<b>NC</b> X4 Screw	<b>S</b> X1 L-576mm
<b>ZA</b> X1 Bx32	<b>H</b> X24 6.3x13	<b>TB</b> X1 Screw	<b>TA</b> X1 Bracket	<b>ZE</b> X4 Washer	<b>Z</b> X16 Screw	<b>ZC</b> X25 Washer	<b>SLZ</b> X6 Washer	<b>X</b> X20 Screw
<b>A</b> X42 Screw	<b>B</b> X24 Screw	<b>RC</b> X4 Bracket	<b>RC</b> X4 Bracket	<b>GLUE</b> X1 Glue	<b>PB</b> X4 Screw	<b>ND</b> X25 Screw	<b>ZD</b> X4 Washer	<b>NC</b> X4 Screw
<b>RC</b> X8 Bracket	<b>RC</b> X4 Bracket	<b>ZE</b> X4 Washer	<b>Z</b> X16 Screw	<b>PC</b> X8 Screw	<b>ND</b> X25 Screw	<b>ZD</b> X4 Washer	<b>NC</b> X4 Screw	<b>S</b> X1 L-576mm

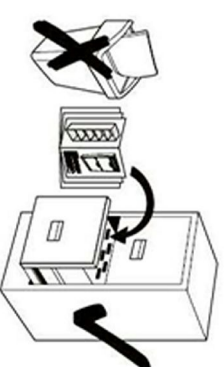
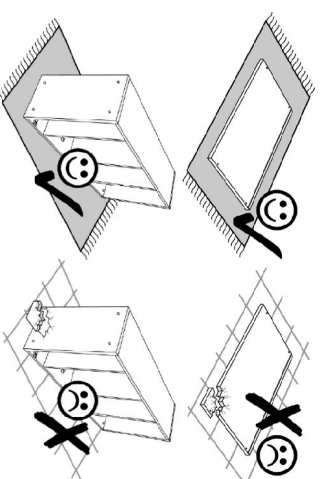

2

**A**  
Bx32  
x18  
**GLUE**  
x1

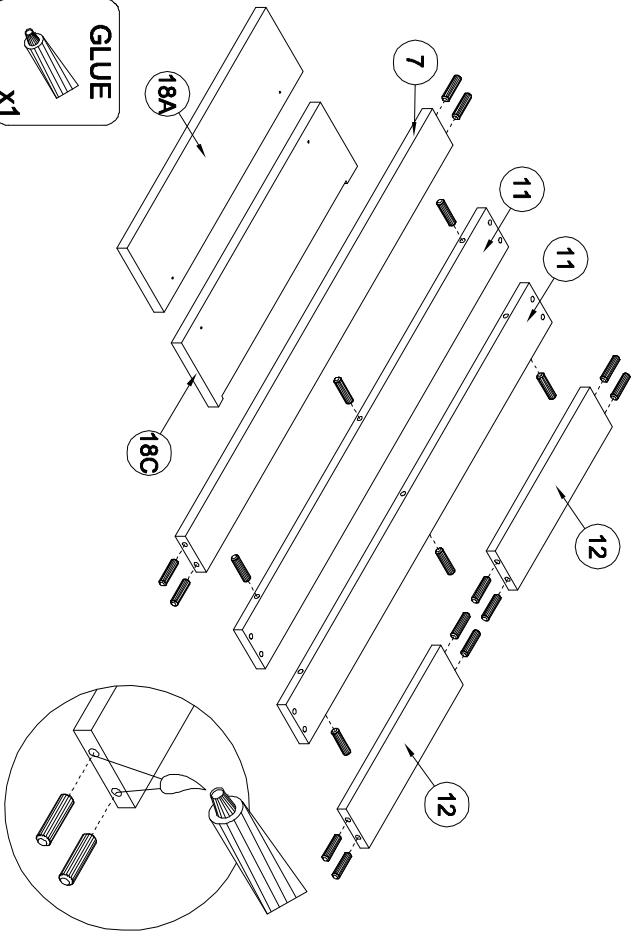

**3**

**GLUE**  
x1

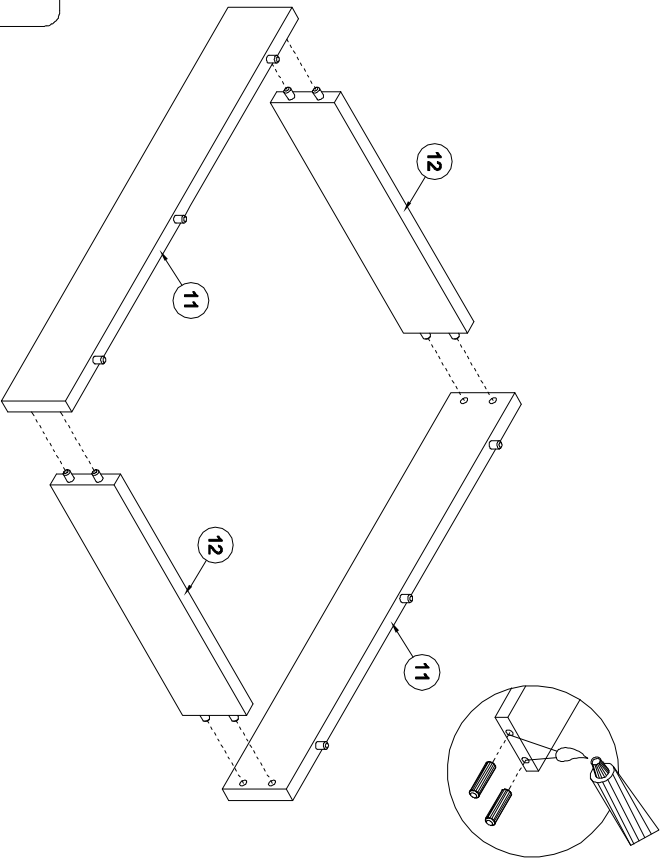

**4**

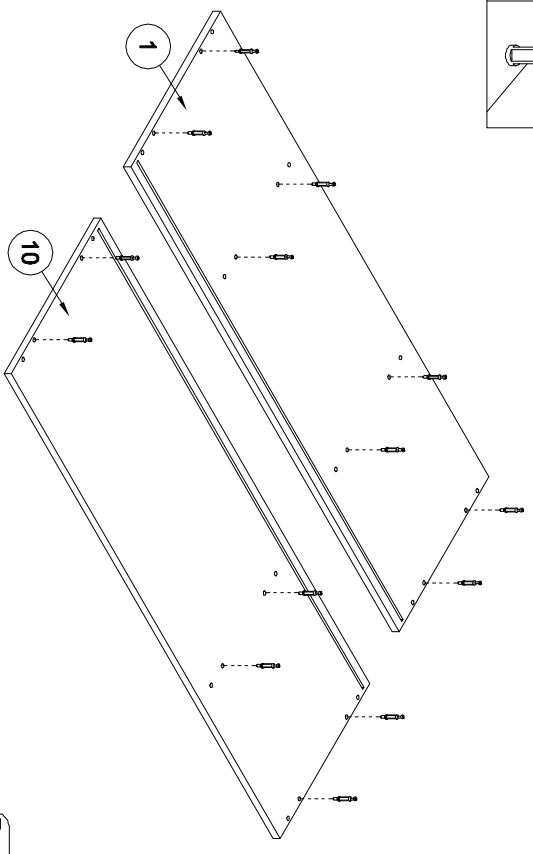
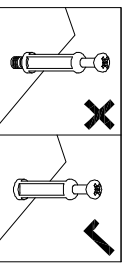

**5**

**B**  
x14

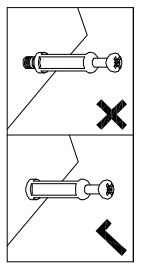

**TOP**  
**BOTTOM**

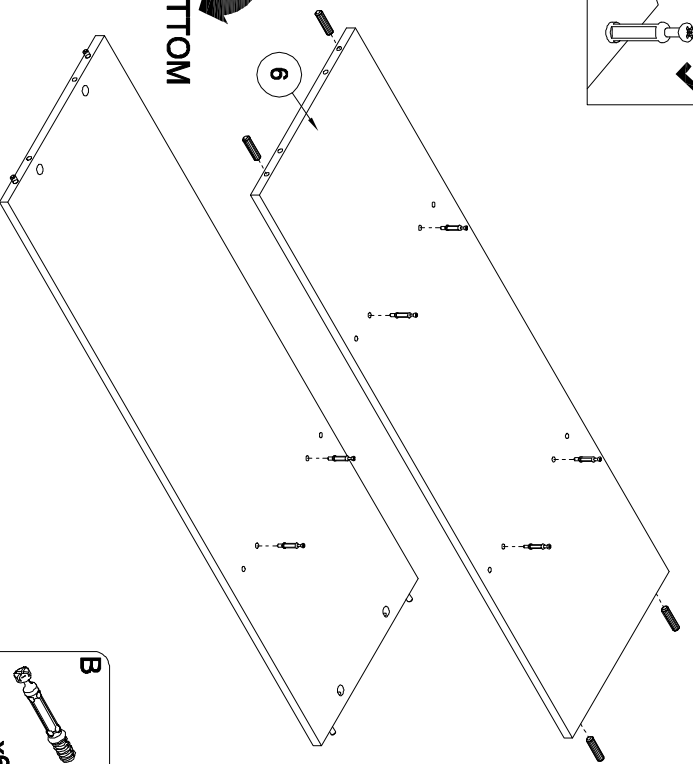

**6**

**B**  
x6  
**A**  
Bx32  
x4

7

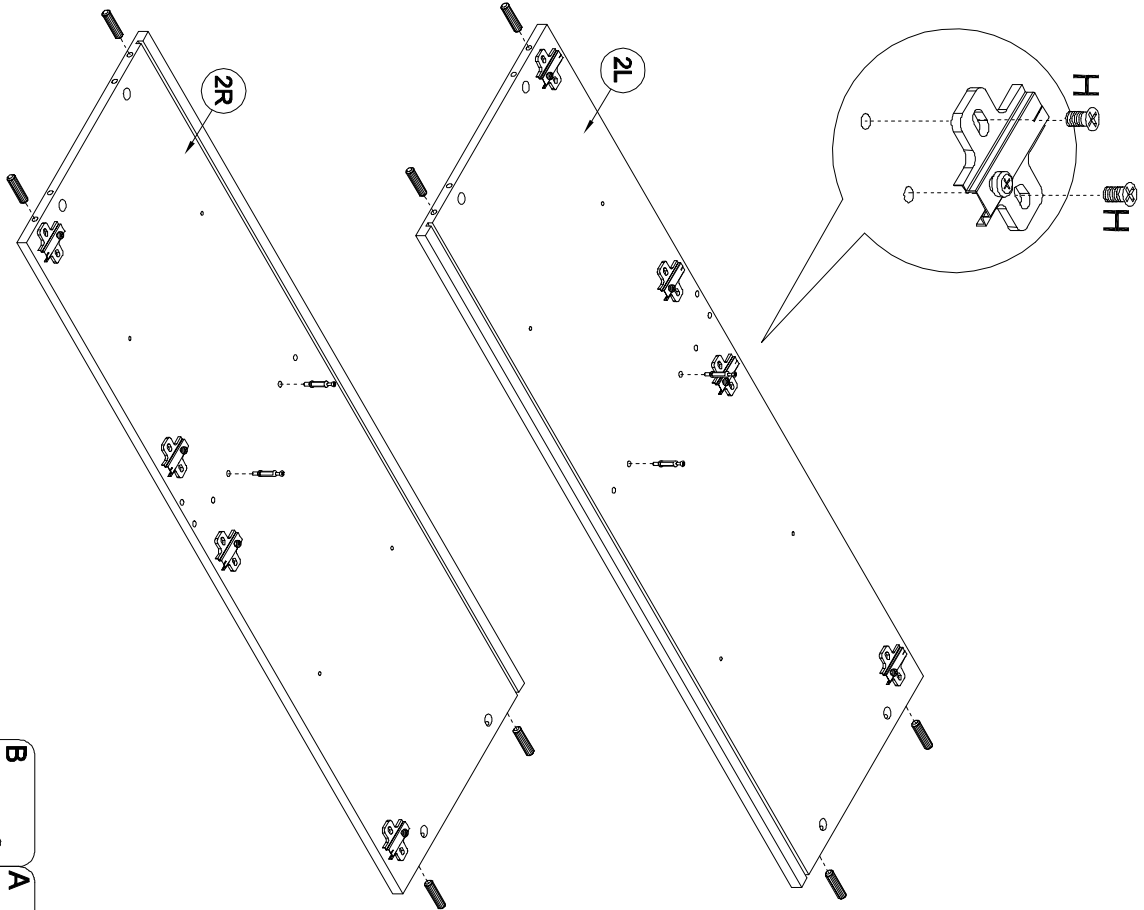
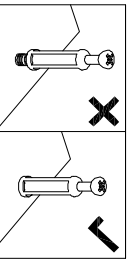

- |                        |                        |                           |                      |
|------------------------|------------------------|---------------------------|----------------------|
| <b>B</b><br>8x32<br>X4 | <b>A</b><br>8x32<br>X8 | <b>H</b><br>6.3x13<br>X16 | <b>RC mini</b><br>X8 |
|------------------------|------------------------|---------------------------|----------------------|

8

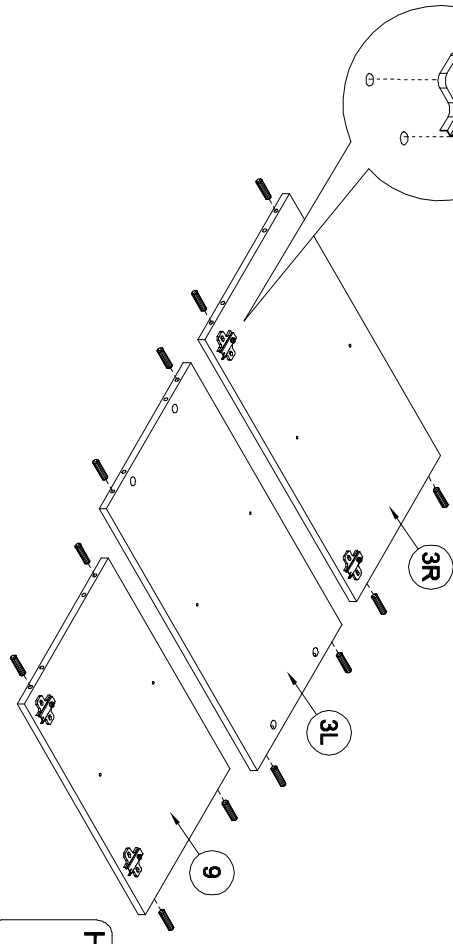
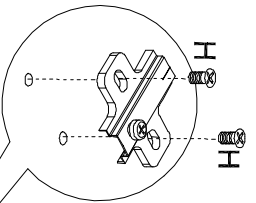

- |                          |                         |                     |
|--------------------------|-------------------------|---------------------|
| <b>H</b><br>6.3x13<br>X8 | <b>A</b><br>8x32<br>X12 | <b>RC 1/2</b><br>X4 |
|--------------------------|-------------------------|---------------------|

9

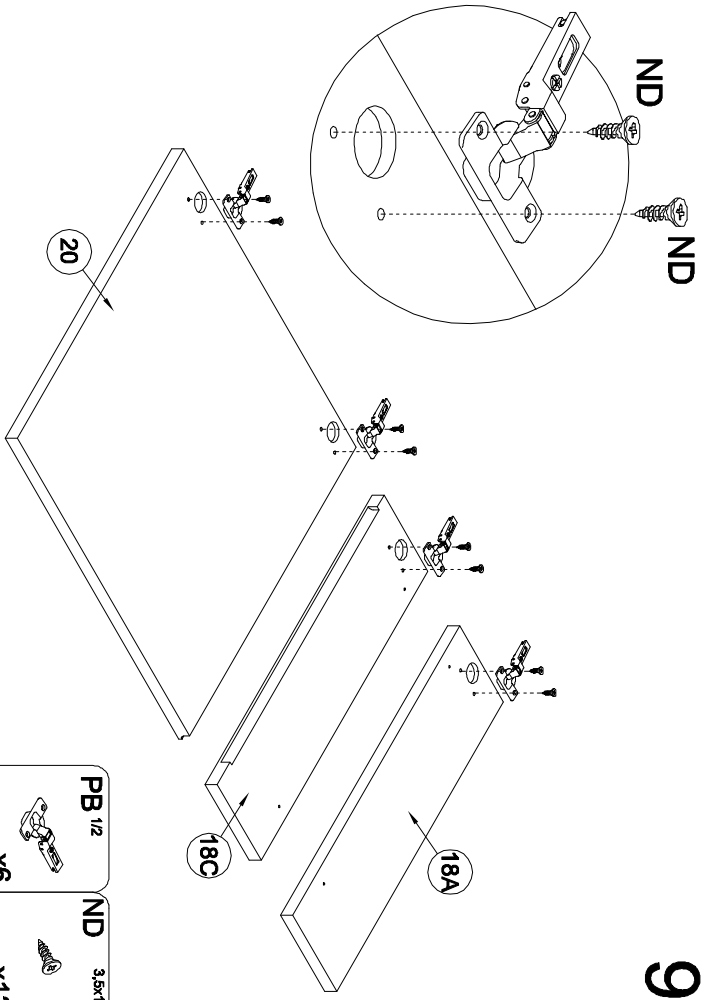
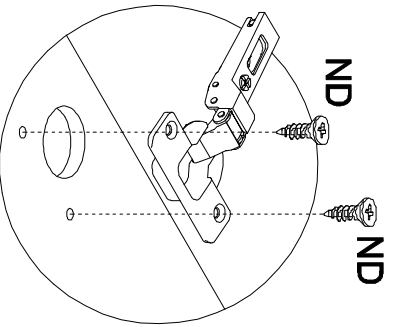

- |                            |                     |
|----------------------------|---------------------|
| <b>ND</b><br>3.5x16<br>X12 | <b>PB 1/2</b><br>X6 |
|----------------------------|---------------------|

GLUE  
x1

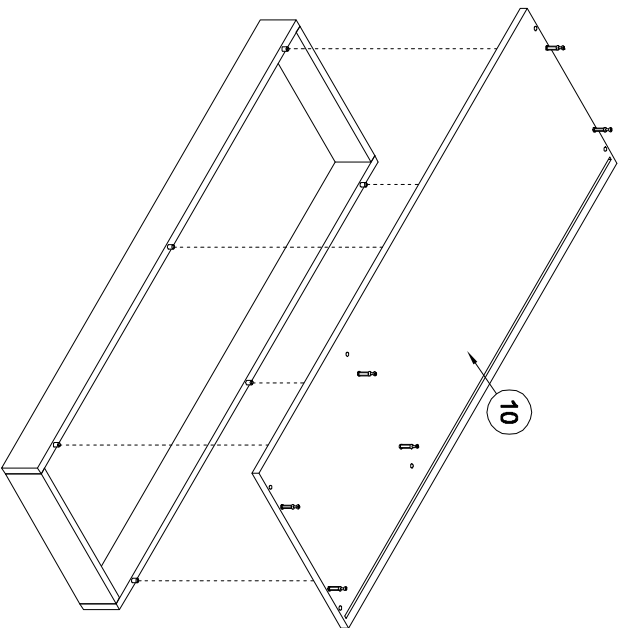
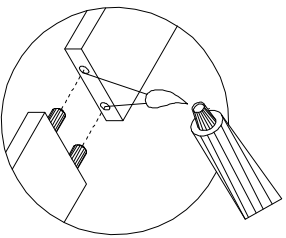

10

PC mini domyk x8  
ND 3.5x16 x16

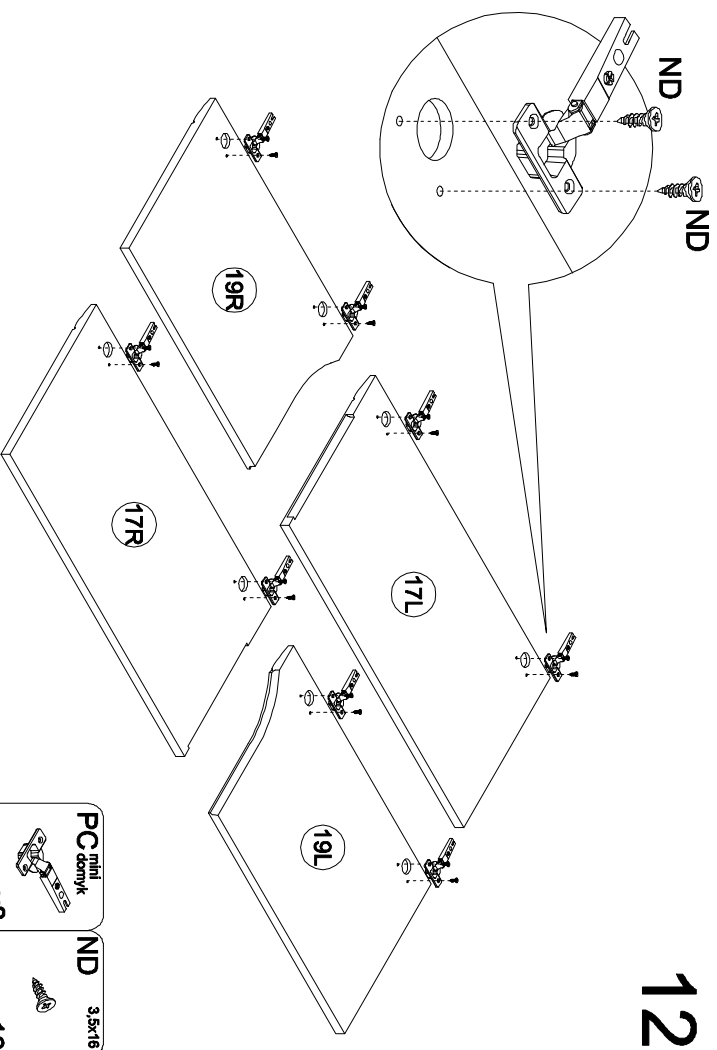

12

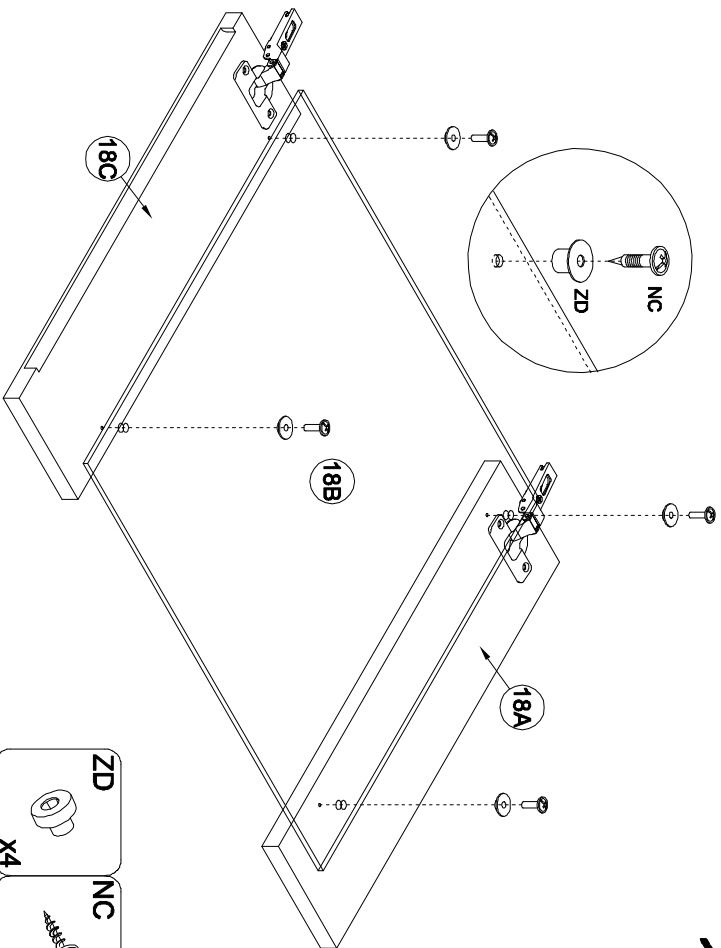
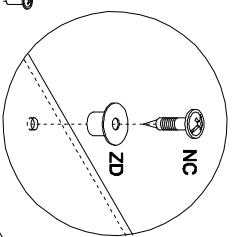

11

ZD x4  
NC 4x16 x4

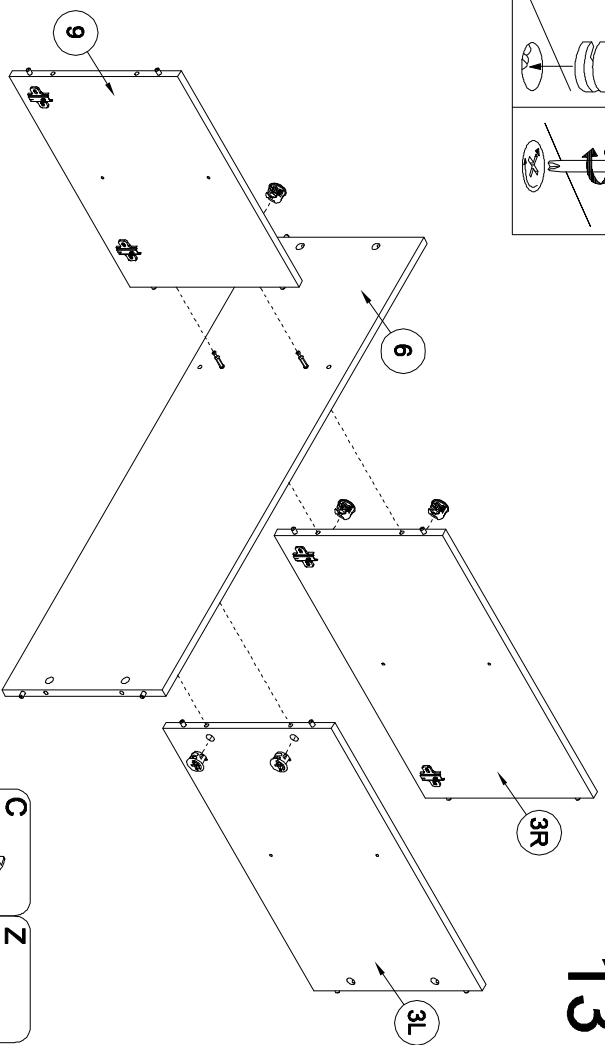
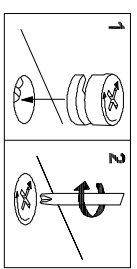

13

C x6  
Z x6

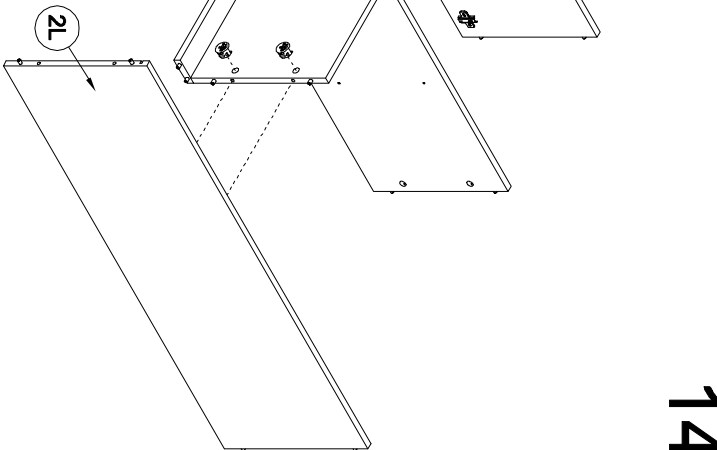
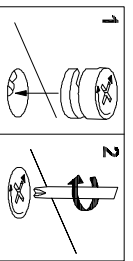

14

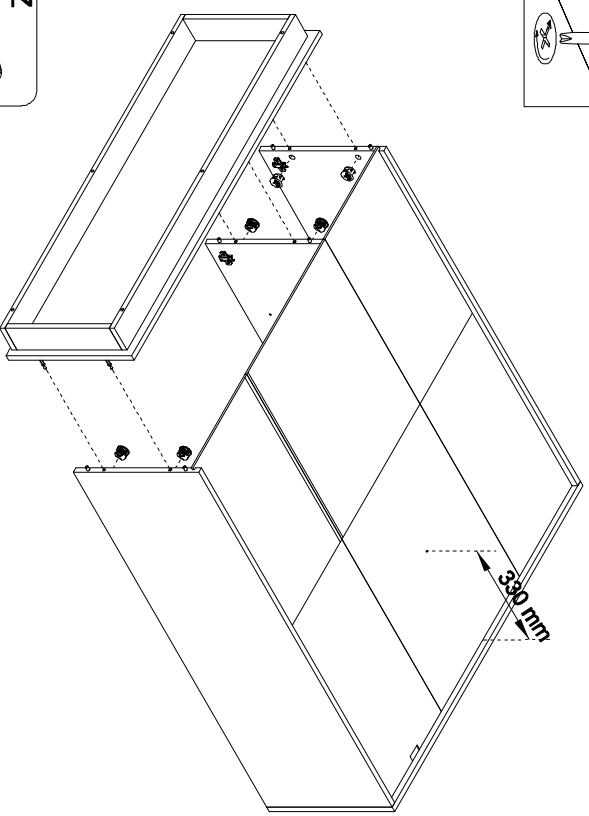
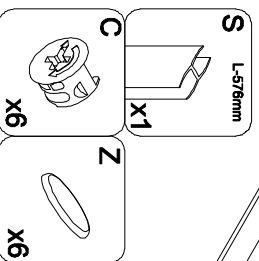
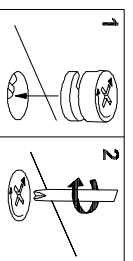

16

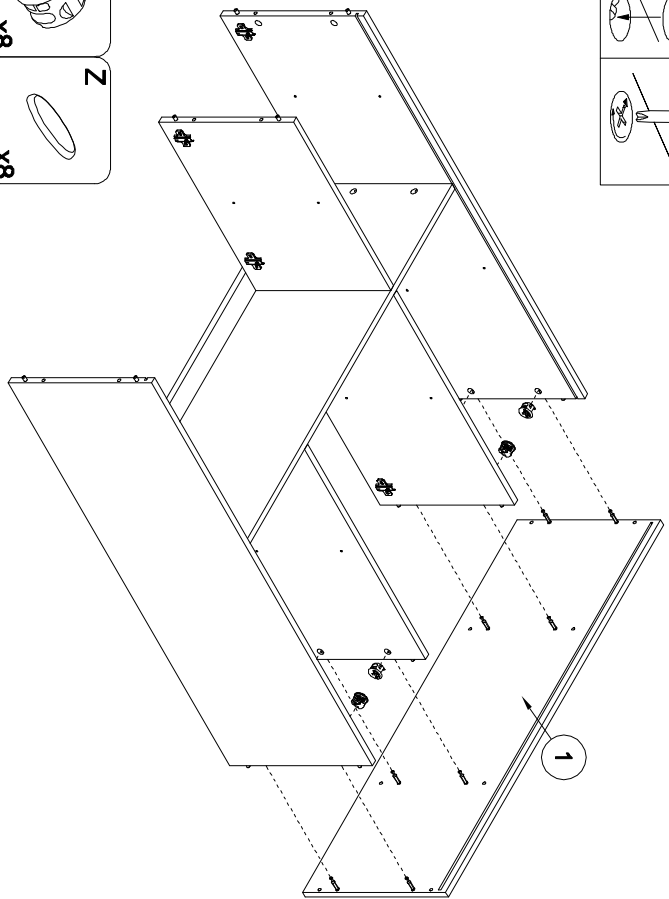
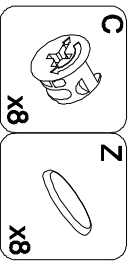
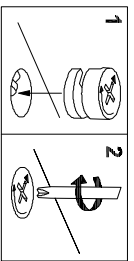

15

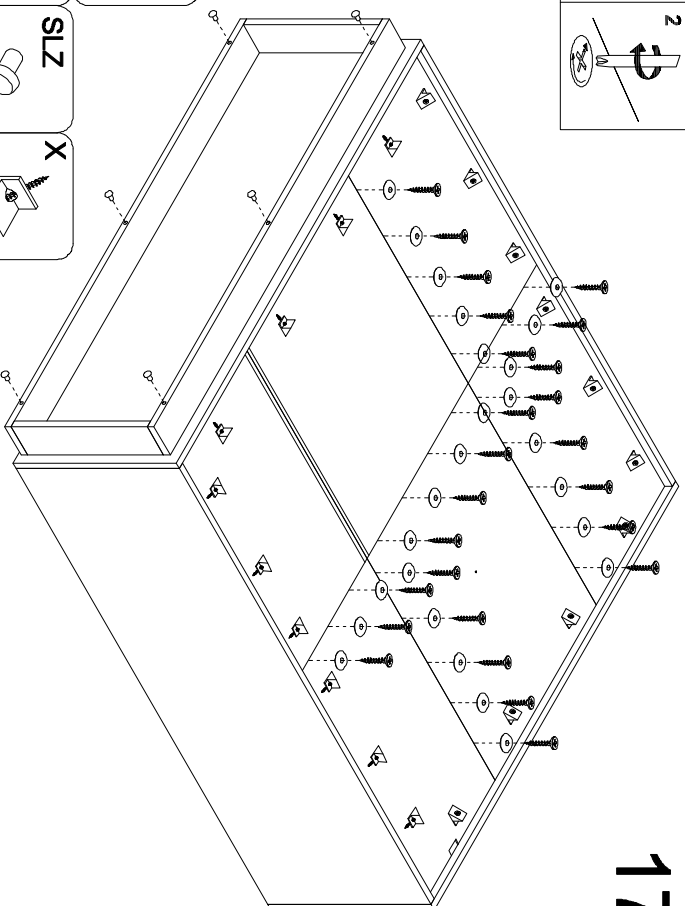
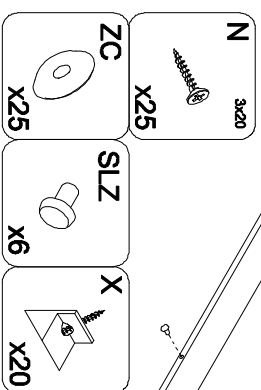
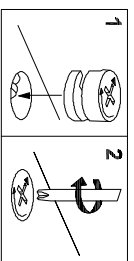

17

18

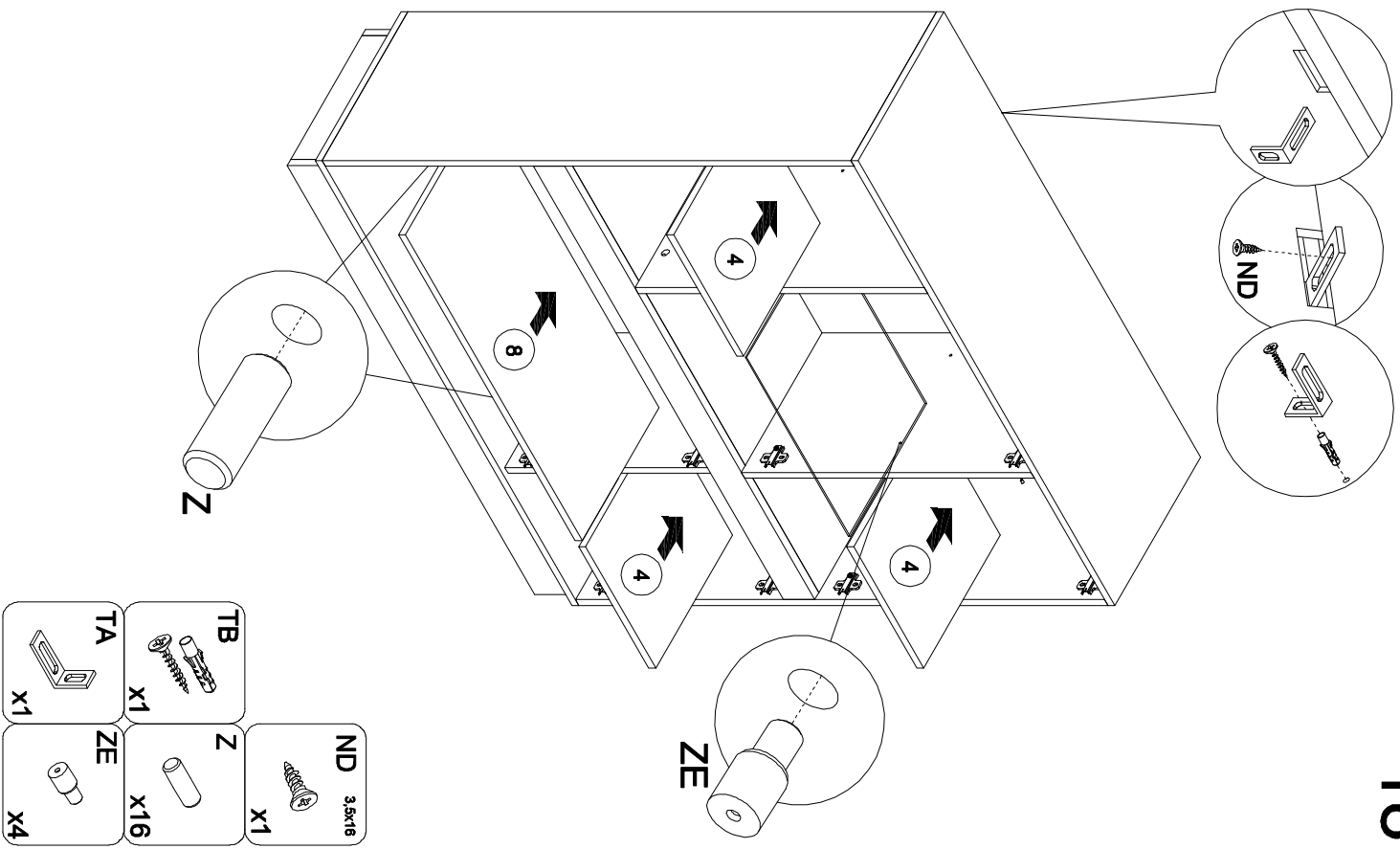

19

