

# Art. Nr. 88623003, 73479204

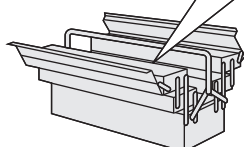

- |           |                                    |           |                                |
|-----------|------------------------------------|-----------|--------------------------------|
| <b>D</b>  | <b>Montageanleitung</b>            | <b>GB</b> | <b>Assembly instructions</b>   |
| <b>FR</b> | <b>Notice de montage</b>           | <b>IT</b> | <b>Istruzioni di montaggio</b> |
| <b>NL</b> | <b>Handleiding voor de montage</b> | <b>PL</b> | <b>Instrukcja montażu</b>      |
| <b>CZ</b> | <b>Montážní návod</b>              | <b>SK</b> | <b>Návod na montáž</b>         |
| <b>HU</b> | <b>Szerelési útmutató</b>          | <b>RO</b> | <b>Instrucțiuni de montaj</b>  |
| <b>TR</b> | <b>Montaj talimatı</b>             | <b>RU</b> | <b>Инструкция по монтажу</b>   |

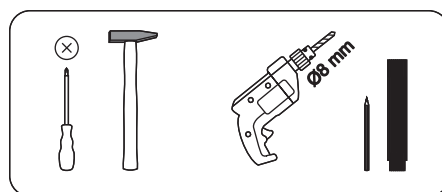

**Service • Assistenza • Dienstverlening • Serwis  
Servis • Szerviz • Сервисная служба**

Name • Nom • Nome • Naam •  
Nazwa • Jméno • Názov • Név •  
Denimire • İsim • Название

Nr. • No. • N° • Номер • Č • Sz  
**88623003, 73479204**

Typ • Type • Tip •  
Típus • Tipo • Тип

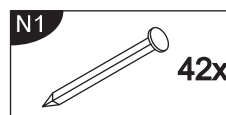
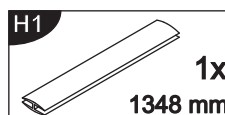
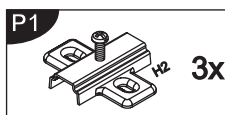
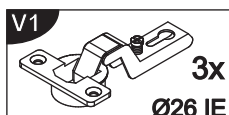
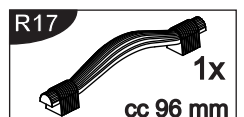
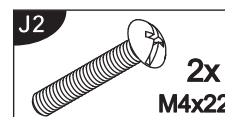
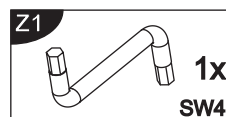
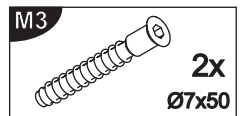
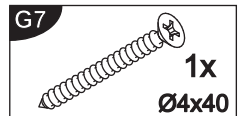
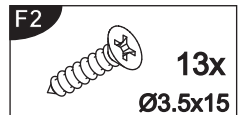
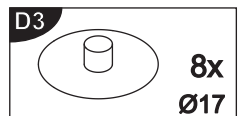
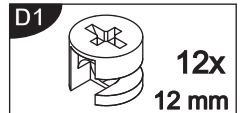
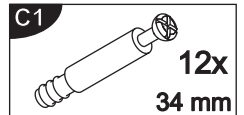
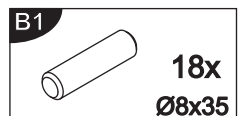
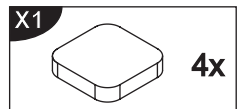
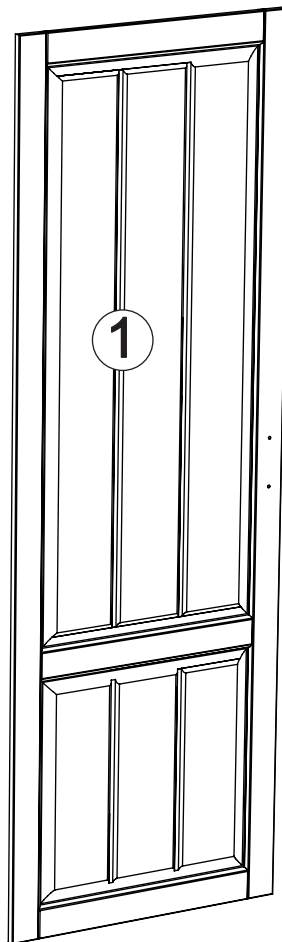
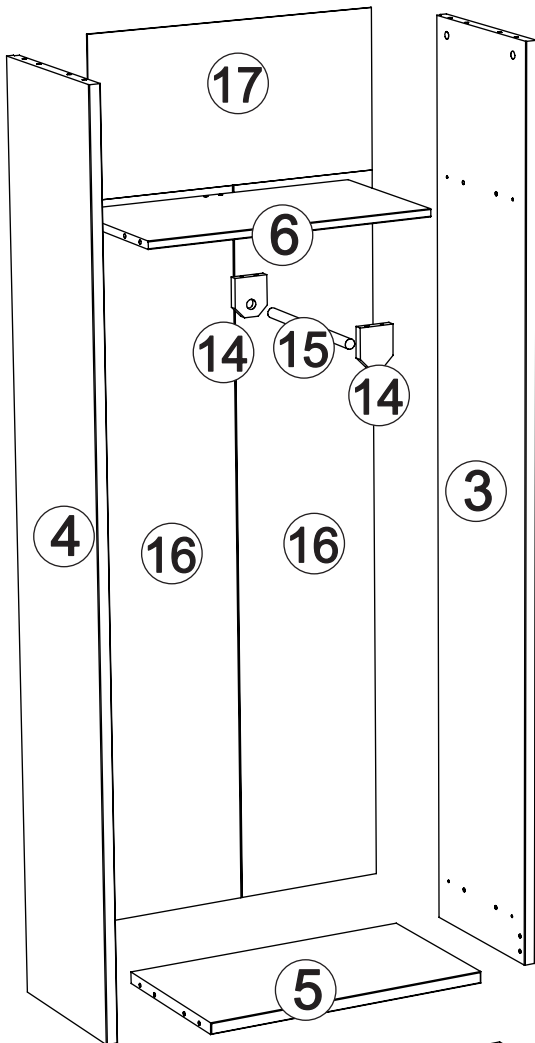
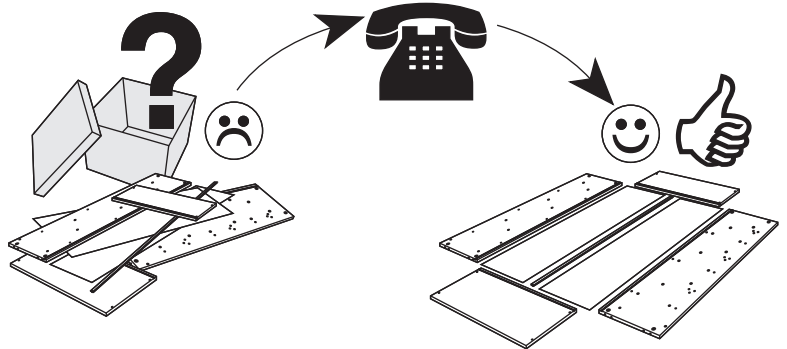
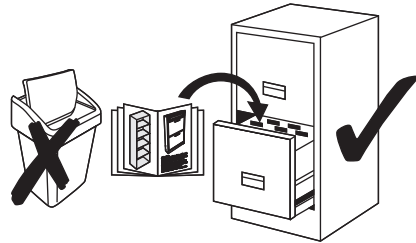

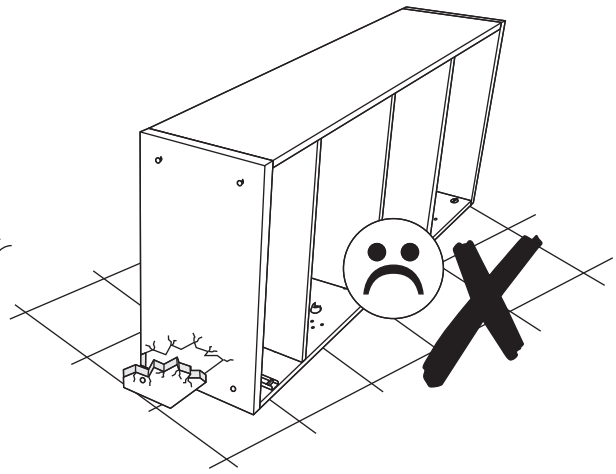

1

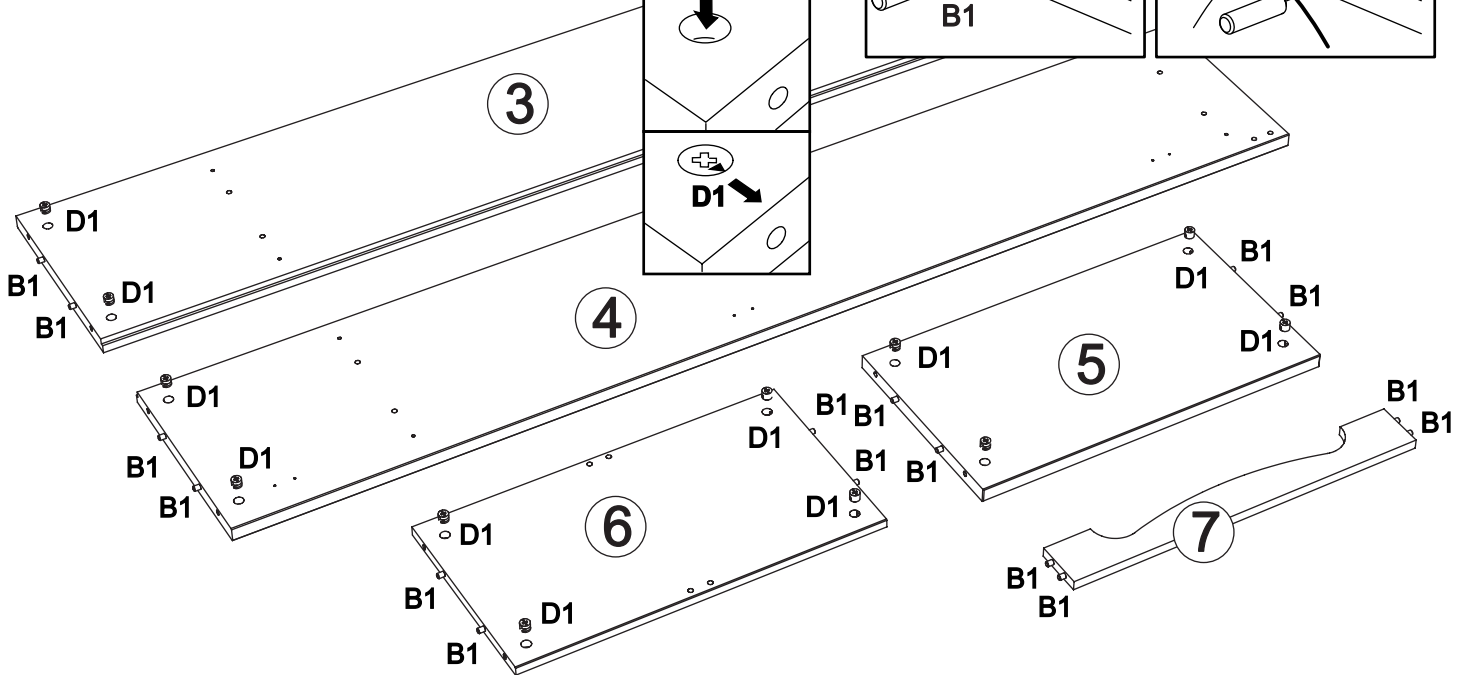
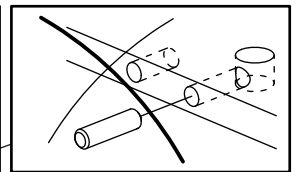
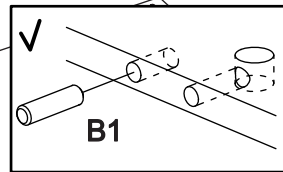
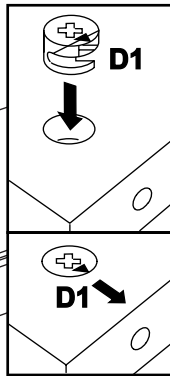
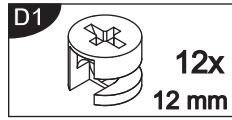
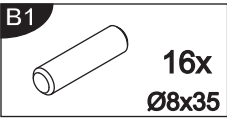

2

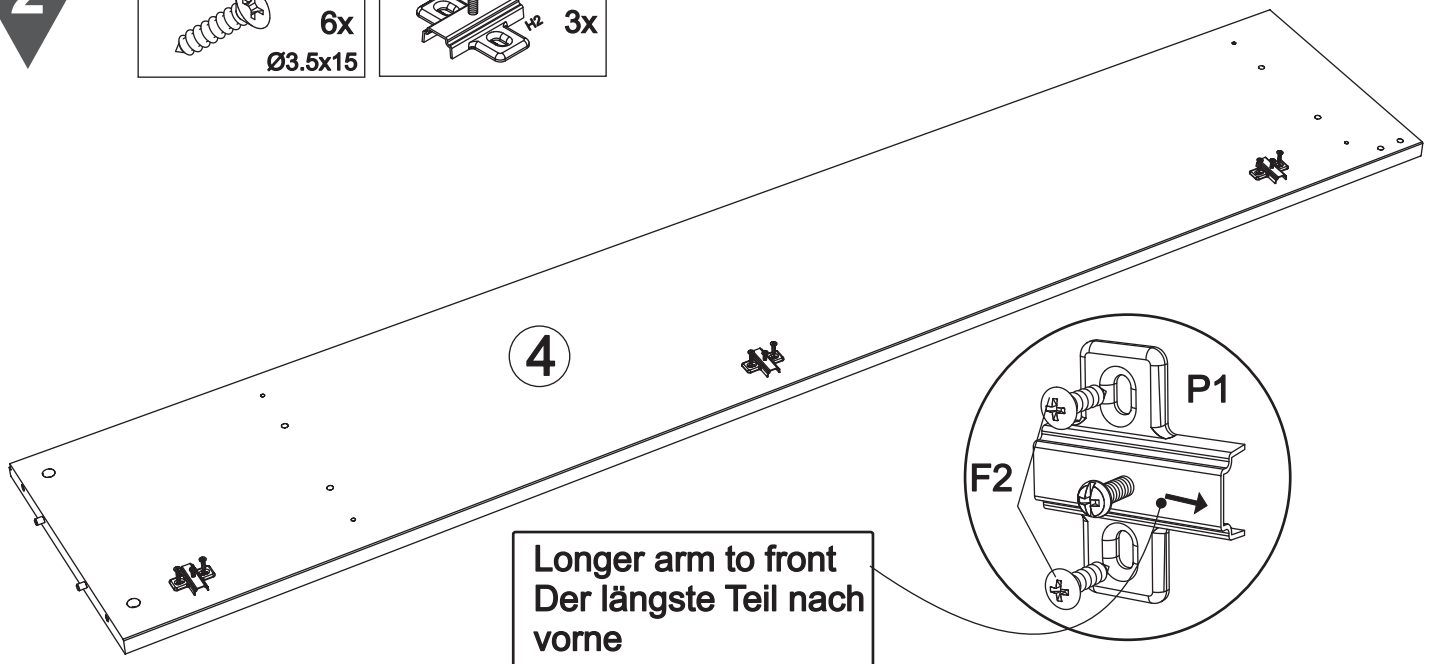
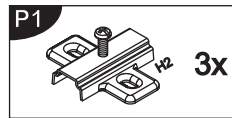
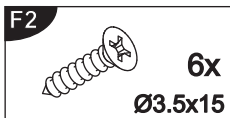



5

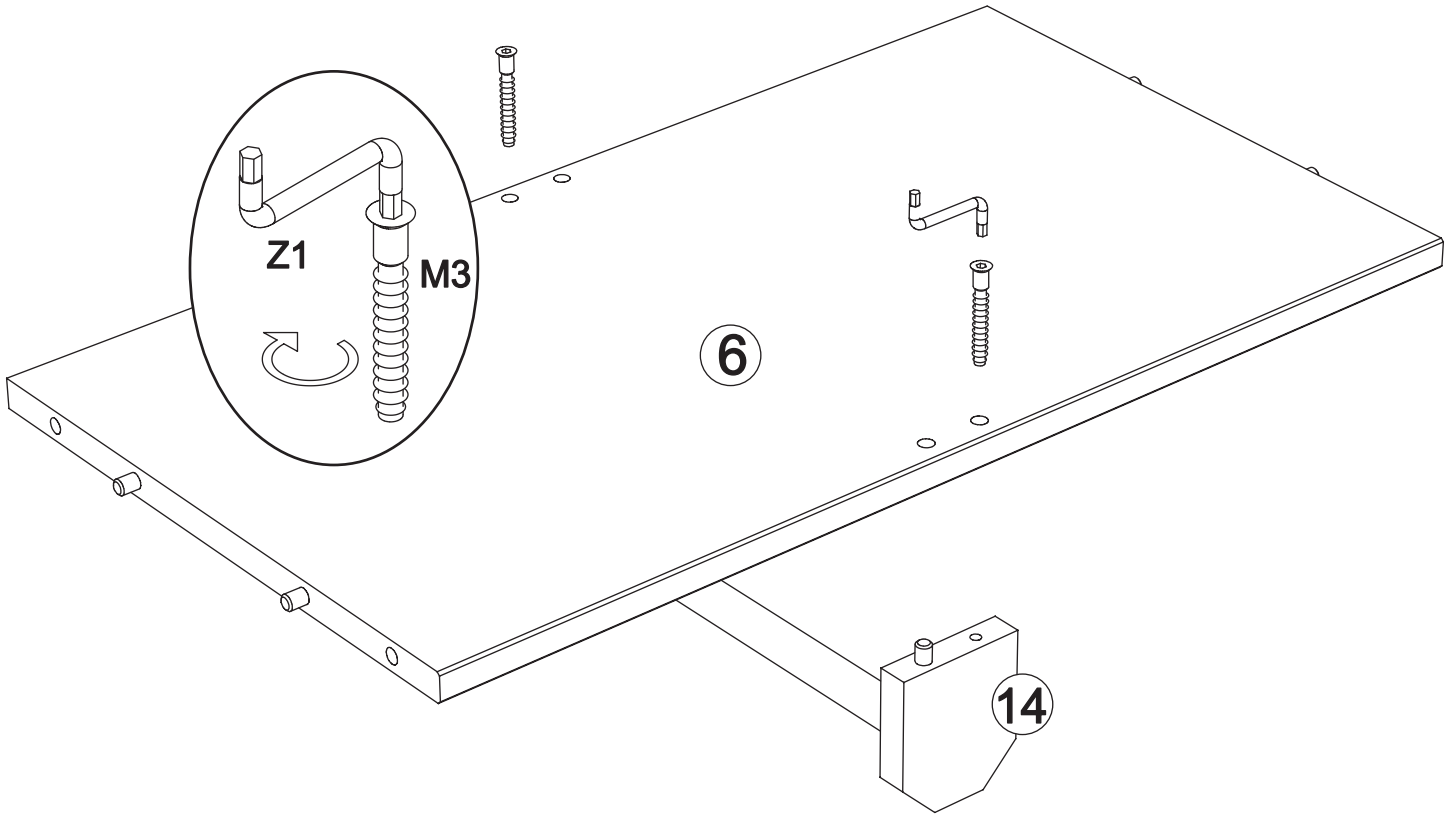
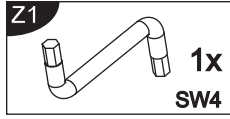
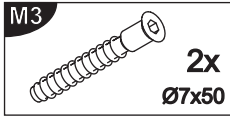

6

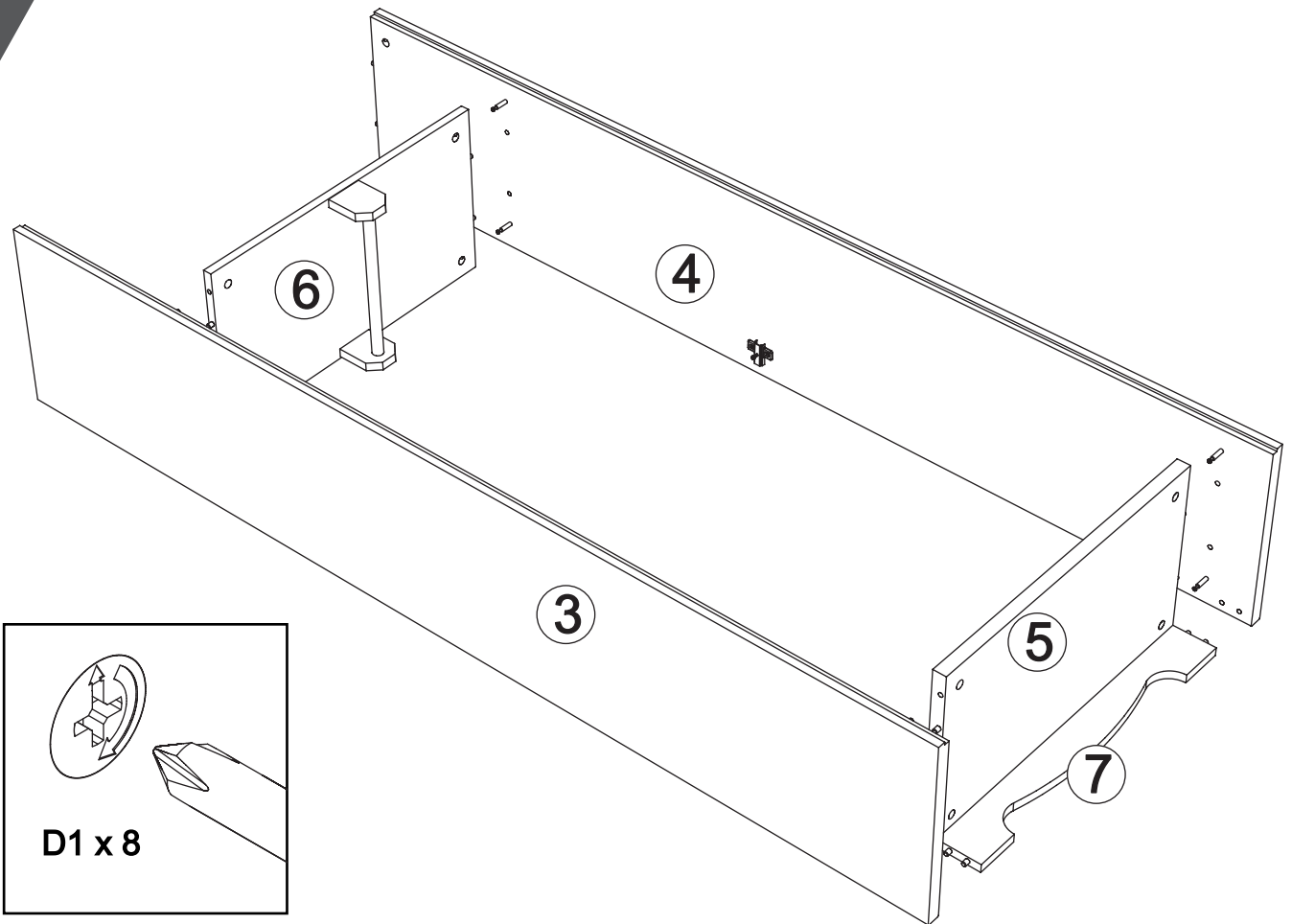





9

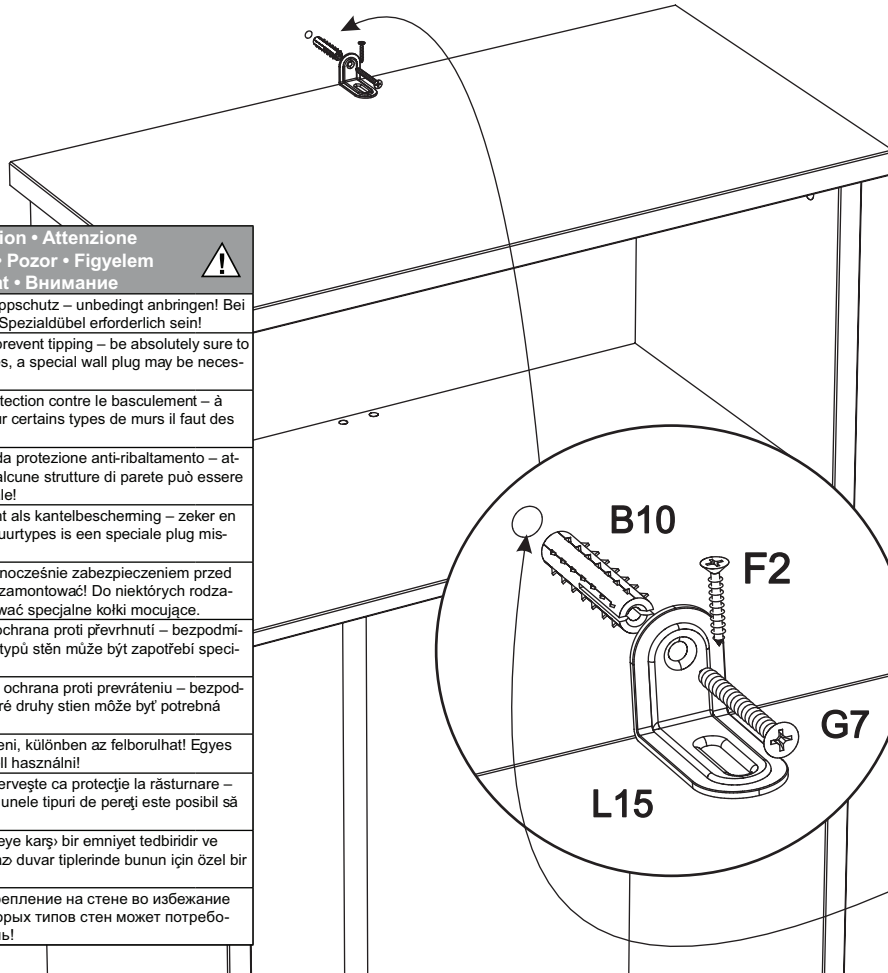

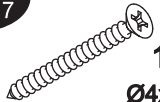
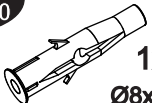
⚠ Achtung • Attention • Attenzione ⚠ Opgelet • Uwaga • Pozor • Figyelem ⚠ Atenție • Dikkat • Внимание ⚠	
<b>(D)</b>	Wandbefestigung dient als Kippschutz – unbedingt anbringen! Bei einigen Wandtypen kann ein Spezialdübel erforderlich sein!
<b>(GB)</b>	The wall fastening serves to prevent tipping – be absolutely sure to mount it! For certain wall types, a special wall plug may be necessary!
<b>(FR)</b>	La fixation murale sert de protection contre le basculement – à installer impérativement ! Pour certains types de murs il faut des chevilles spéciales !
<b>(IT)</b>	Il fissaggio alla parete serve da protezione anti-ribaltamento – attaccarla assolutamente! Per alcune strutture di parete può essere necessario un tassello speciale!
<b>(NL)</b>	Bevestiging aan de muur dient als kantelbescherming – zeker en vast bevestigen! Bij enkele muurtypes is een speciale plug misschien vereist!
<b>(PL)</b>	Mocowanie do ściany jest jednocześnie zabezpieczeniem przed przewróceniem – koniecznie zamontować! Do niektórych rodzajów ścian koniecznie zastosować specjalne kołki mocujące.
<b>(CZ)</b>	Montáž na stěnu slouží jako ochrana proti převrnutí – bezpodmienečně umísteť! U některých typů stěn může být zapotřebí speciální hmoždinka!
<b>(SK)</b>	Upevnenie na stenu slúži ako ochrana proti prevráteniu – bezpodmienečne použite! Pre niektoré druhy stien môže byť potrebná špeciálna hmoždinka!
<b>(HU)</b>	A termék a falhoz kel rögzítési, külföldön az felborulhat! Egyes fal típusoknál speciális tiplis kell használni!
<b>(RO)</b>	Sistemul de fixare la perete servește ca protecție la răsturnare – de montat obligatoriu! Pentru unele tipuri de pereți este posibil să fie necesar un diblu special!
<b>(TR)</b>	Duvardaki sabitleme, devrilmeye karşı bir emniyet tedbiridir ve mutlaka monte edilmelidir! Bazı duvar tiplerinde bunun için özel bir dübel gerekli olabilir!
<b>(RU)</b>	Обязательно установите крепление на стене во избежание опрокидывания! Для некоторых типов стен может потребоваться специальный дюбель!

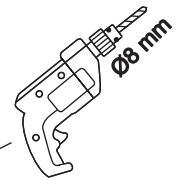

- F2**  
 1x  
Ø3.5x15
- G7**  
 1x  
Ø4x40
- B10**  
 1x  
Ø8x40
- L15**  
 1x  
40x30x20



10

- V1**  
 3x  
Ø26 IE
- F2**  
 6x  
Ø3.5x15

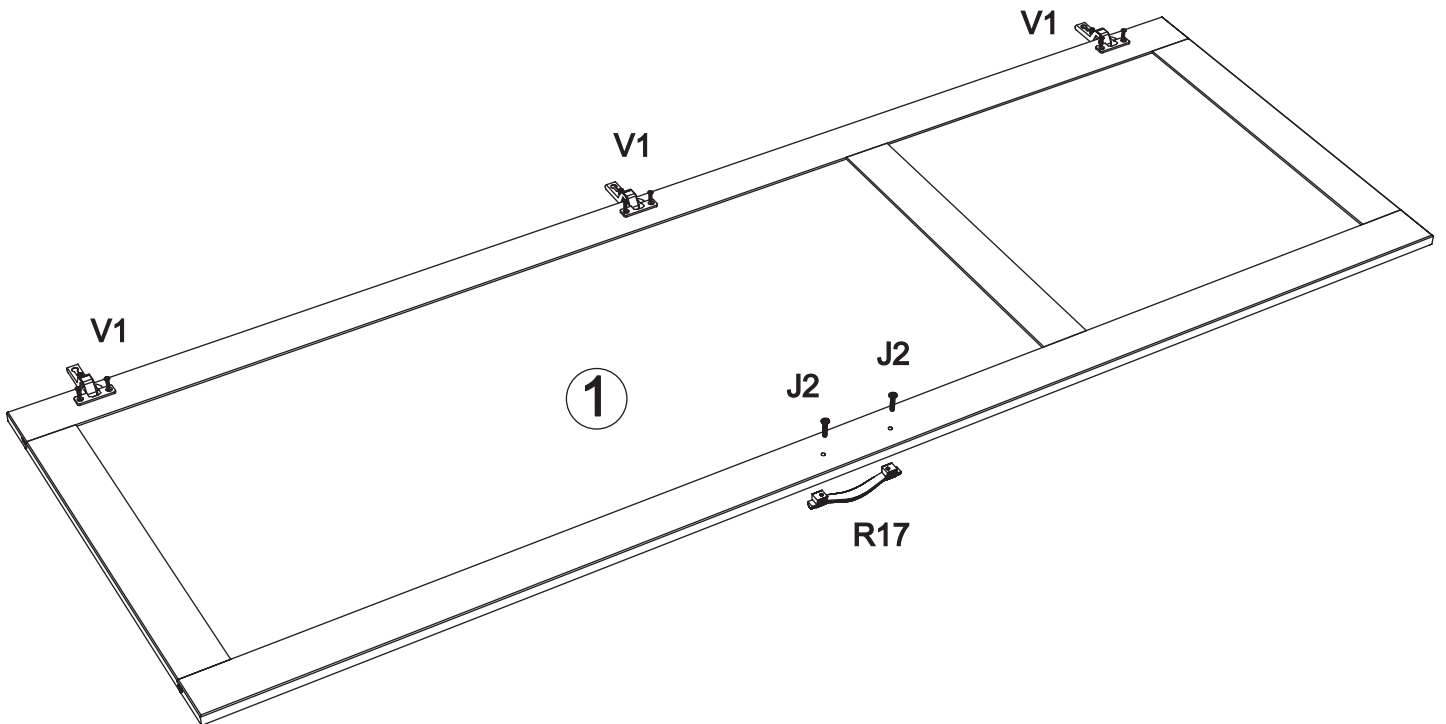

- J2**  
 2x  
M4x22
- R17**  
 1x  
cc 96 mm

