

HEKTOR WM 05

- (PL) Instrukcja montażu
 (CZ) Návod k montáži
 (D) Montageanleitung
 (GB) Assembly instruction
 (F) Model d'emploi
 (HU) Szerelési útmutató
 (I) Istruzione di montaggio
 (NL) Handleiding voor de montage

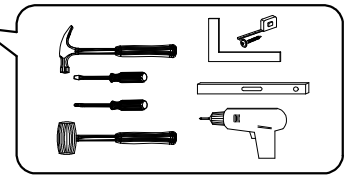

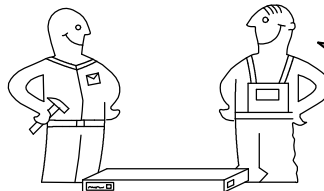



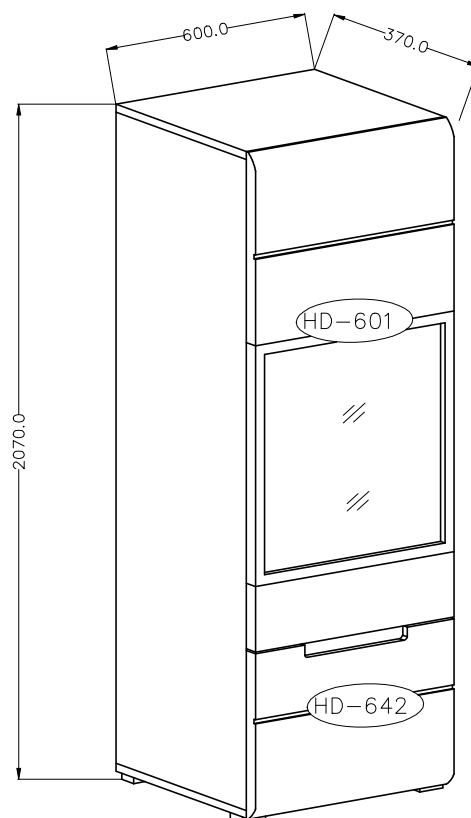
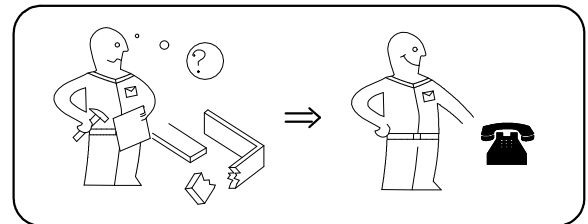
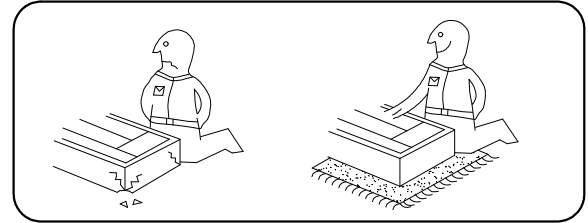



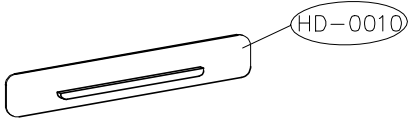
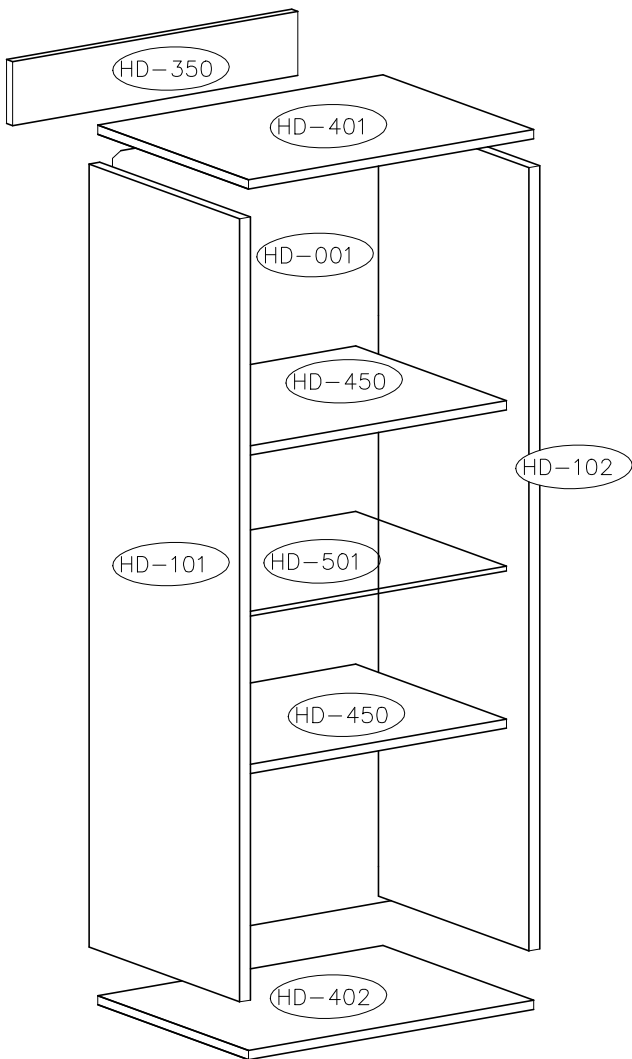
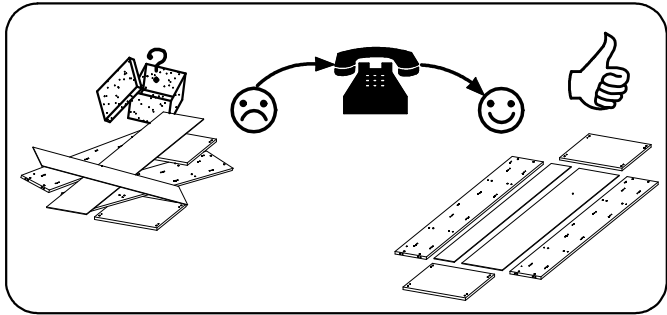
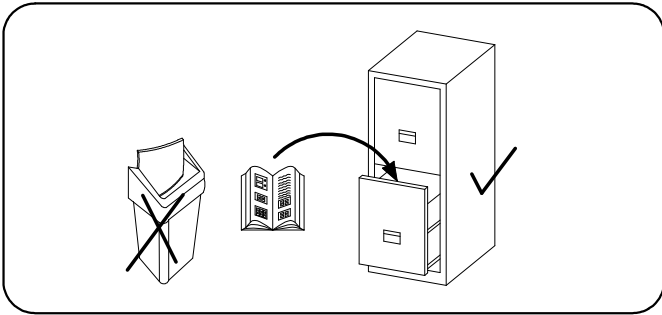

- (RU) Инструкция по монтажу
 (RO) Instrucțiuni de montare
 (SK) Návod k montáži
 (TR) Montaj talimati

Uwaga • Upozornění • Achtung • Attention • Caution • Figyelem Attenzione • Opgelet • Внимание • Ateňje • Upozornenie • Dikkat	
PL	Czyszczenie należy wykonać wyłącznie za pomocą ściereczki lub lekko nawilżonego ręcznika. Nie stosować środków czyszczących do szorowania.
CZ	Čistění je nutné vykonávat výhradně pomocí utěrky nebo lehce navlhčeného ručníku. Nepoužívejte čisticí prostředky obsahující abrazivní částice.
D	Bitte nur mit einem Staubtuch oder leicht feuchtem Lappen reinigen. Keine scheuernden Putzmittel verwenden.
GB	Please only clean with a duster or a damp cloth. Do not use any abrasive cleaners.
F	Le nettoyage se fait uniquement à l'aide d'un torchon ou d'une serviette légèrement mouillée.
HU	A tisztítás kizárólag törleruha vagy enyhén nedvesített törölköző segítségével végezhető. Súroló hatású tisztítószerket nem szabad használni.
I	Pulire esclusivamente con un panno o un asciugamano umido.
NL	Reinig alleen met een stofdoek of een lichtjes vochtige doek. Gebruik geen schurende poetsmiddelen.
RU	Очищайте от пыли тряпкой или слегка влажной ветошью. Не допускается применение чистящих средств, не предназначенных для ухода за мебелью.
RO	Curățarea trebuie efectuată numai cu o cârpă sau cu un prosop ușor umezit. Nu utilizați agenți de curățare abrazivi.
SK	Čistení je nutné vykonávat výhradně pomocí utierky alebo ľahko zvlhnutým ručníkom. Nepoužívajte čistiace prostriedky obsahujúce abrazívne častice.
TR	Lütfen sadece bir toz bezilye veya hafif nemli yumuşak bir bezle siliniz. Aşındırıcı temizlik malzemeleri kullanmayınız.

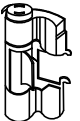

HEKTOR WM 05

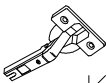
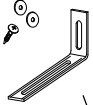

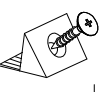

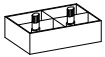
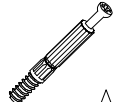
				4.0x13	3.0x13	
A	B	C	D	N	T	E
18	18	16	20	8	10	4
		KR-0 				
U	X	K	V	P	N3	J
2	4	4	1	4	1	8

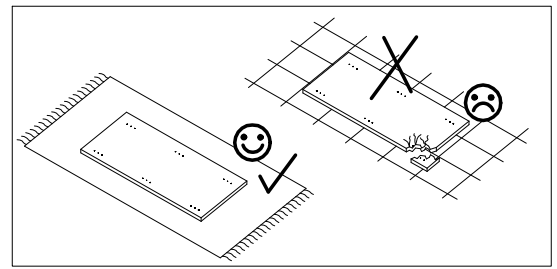
	
P	A
4	8

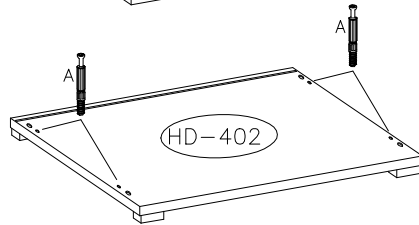
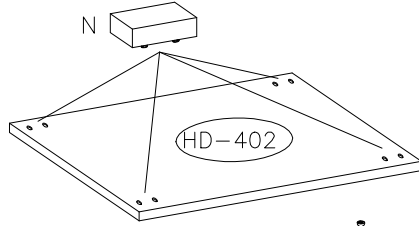
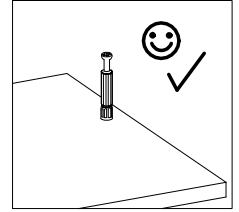
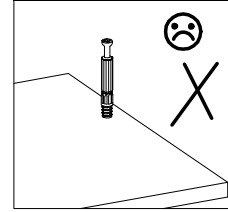
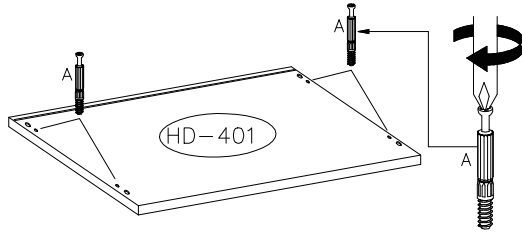

1



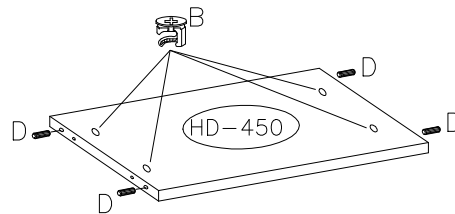
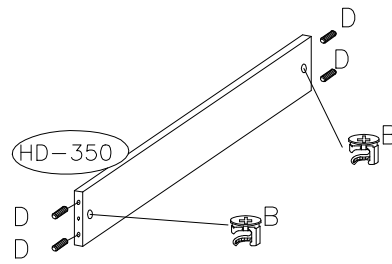

	
B	D
10	12

2



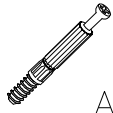

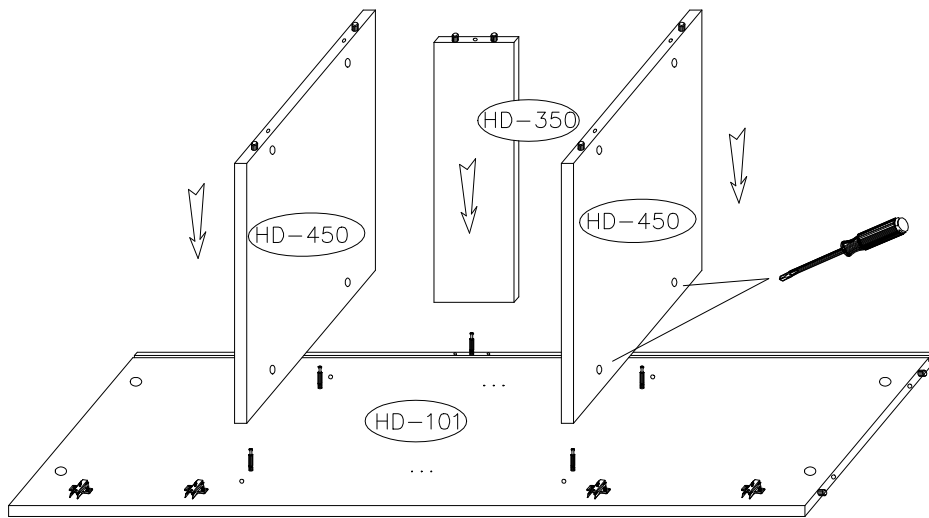
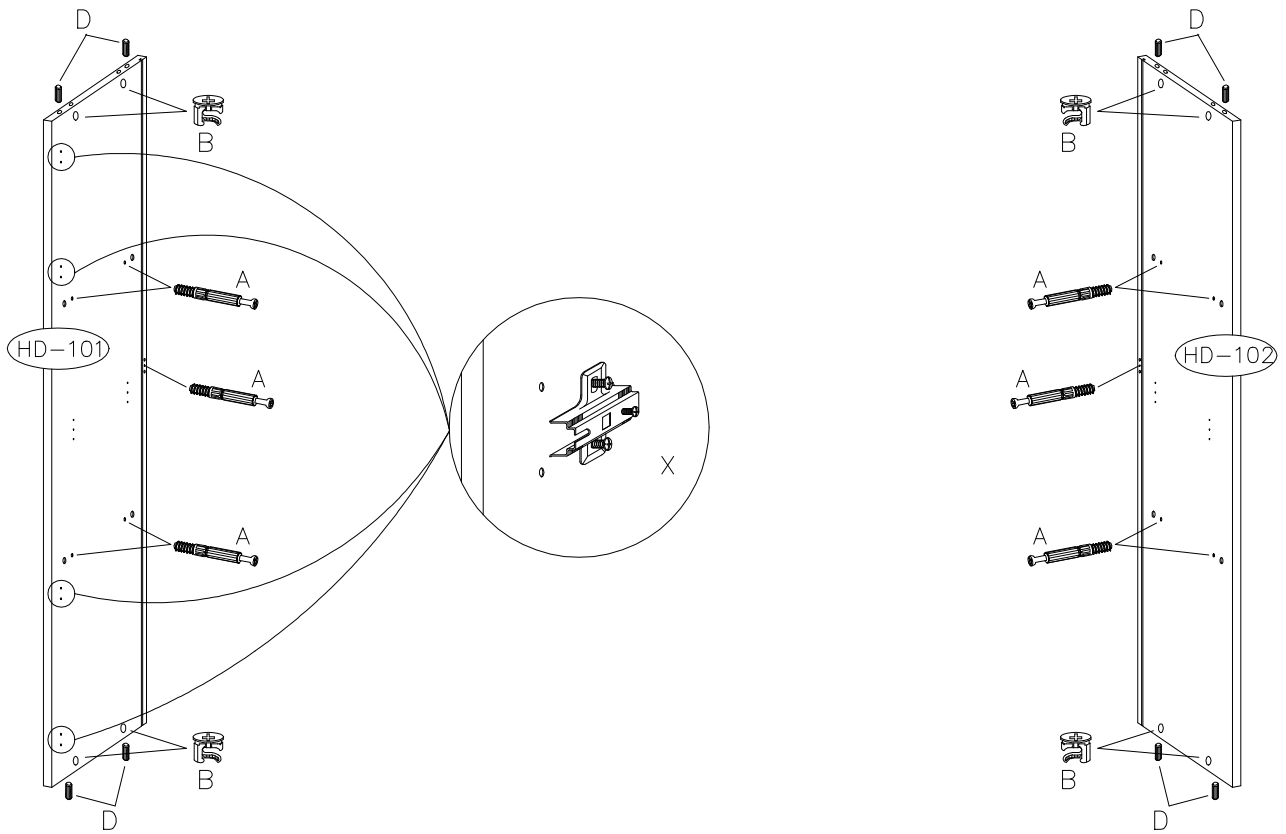

X2

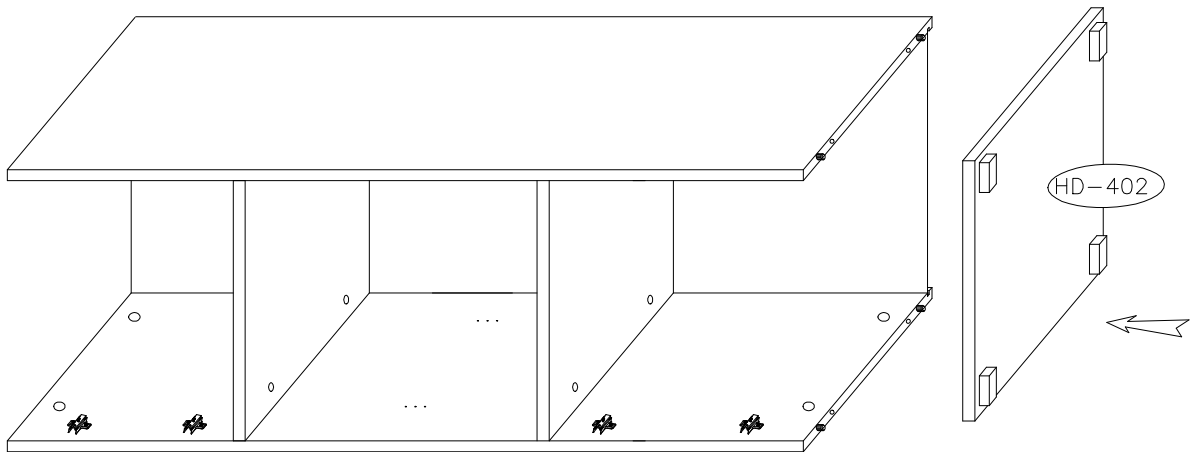
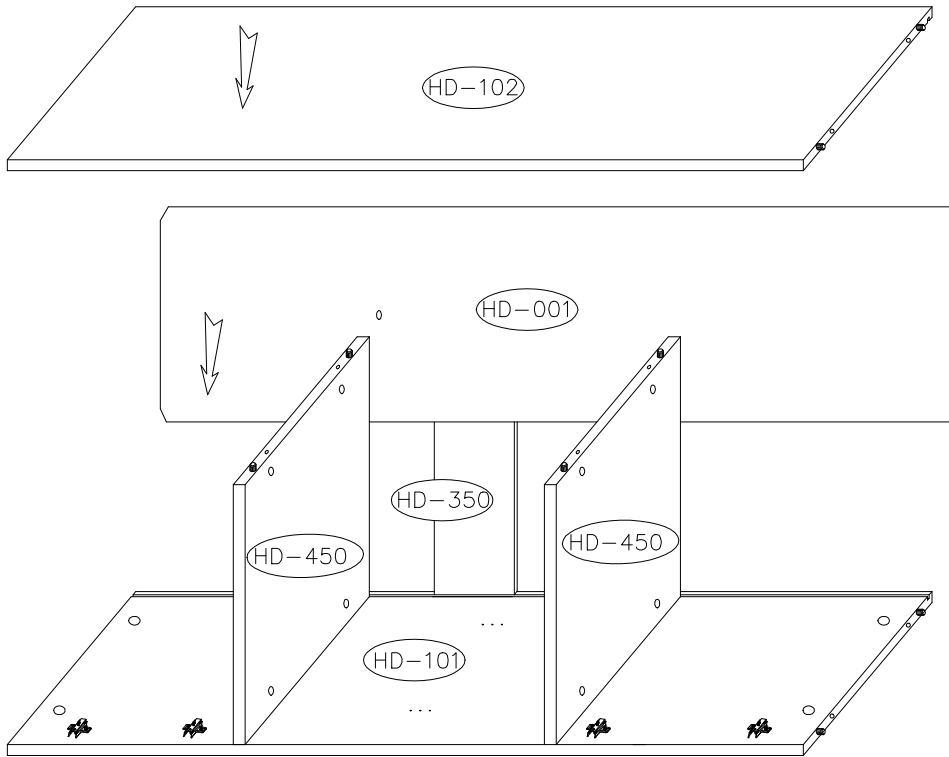
 D	 A	 X	 B
8	10	4	8

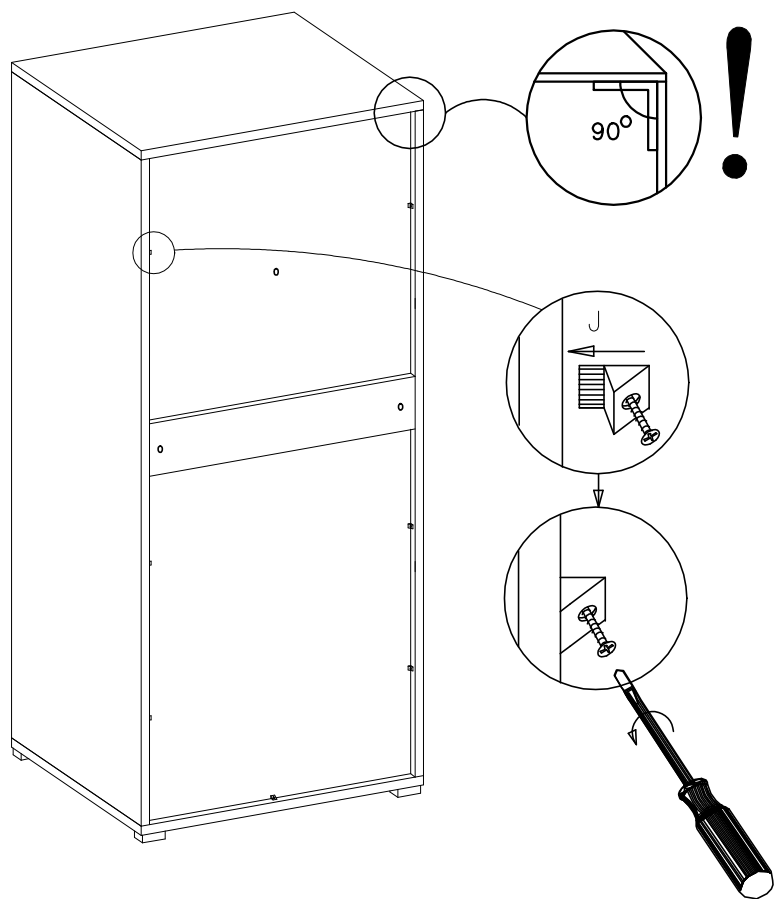
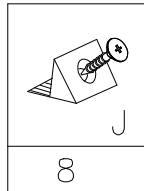
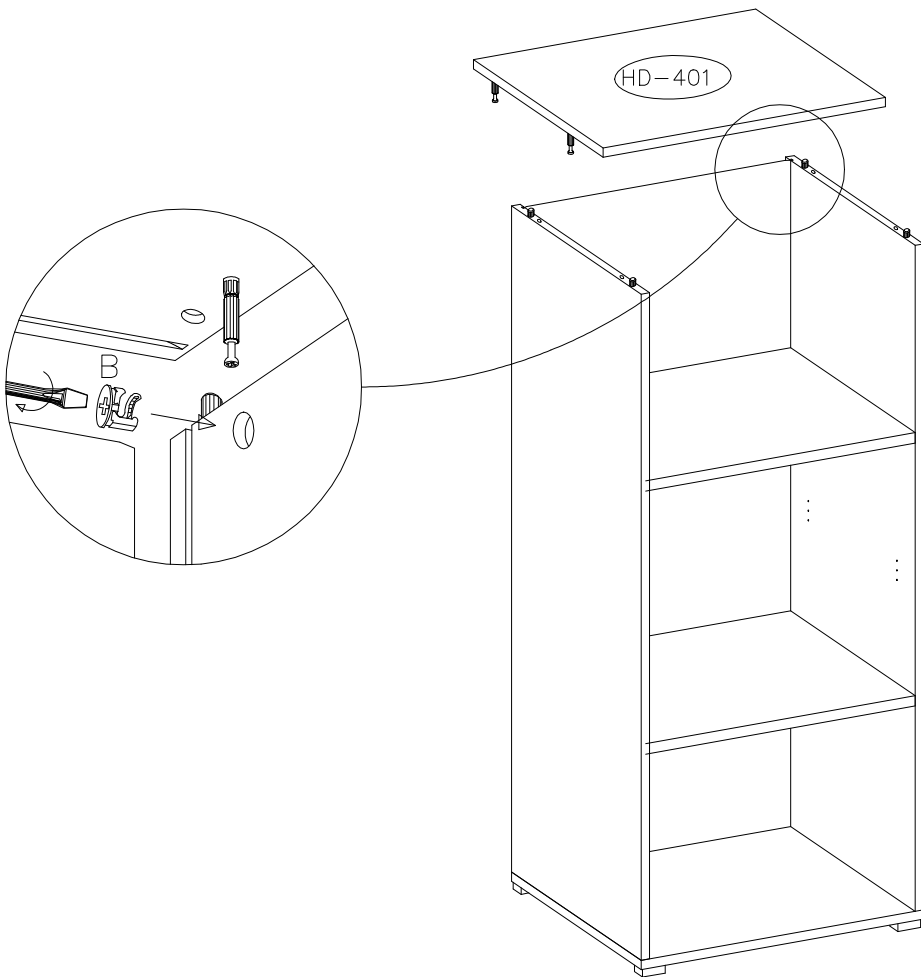





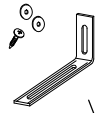

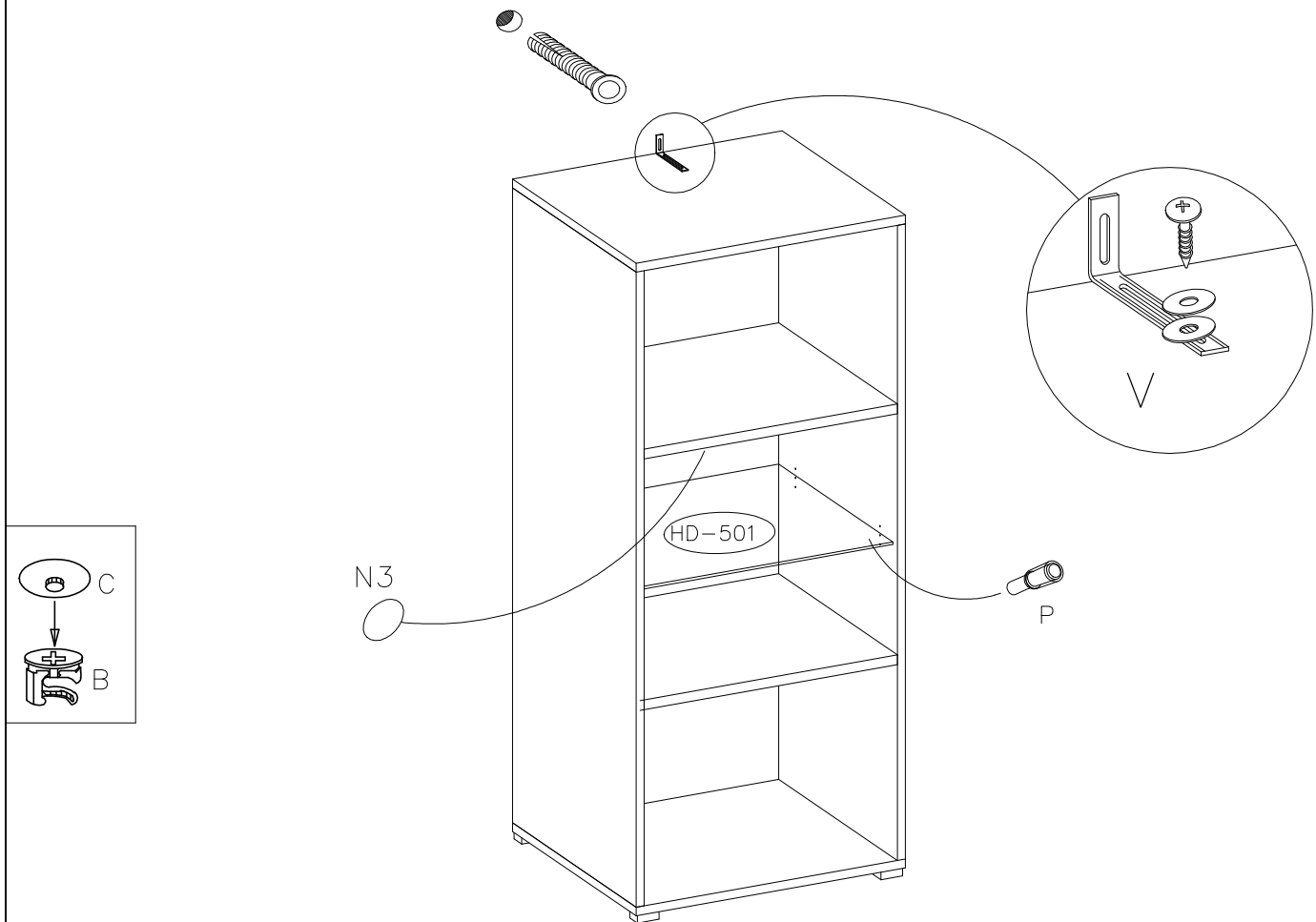



			
E	N3	C	V
4	1	16	1

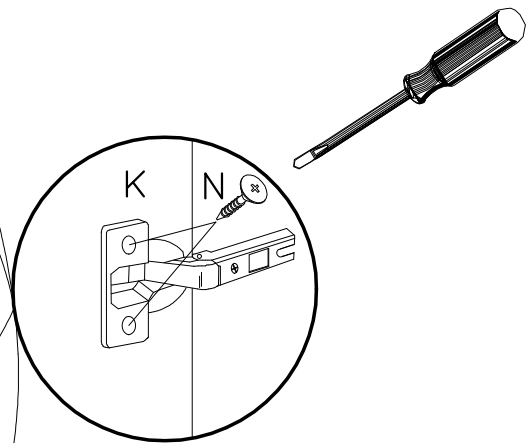
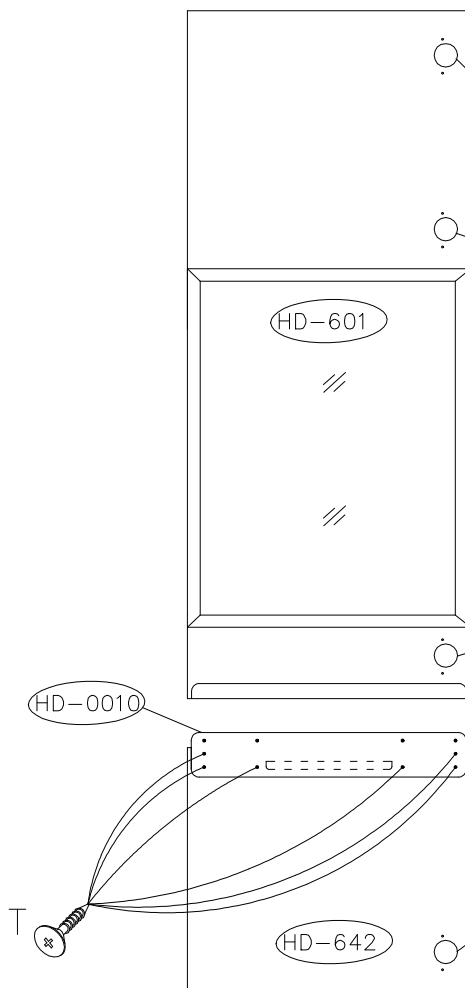
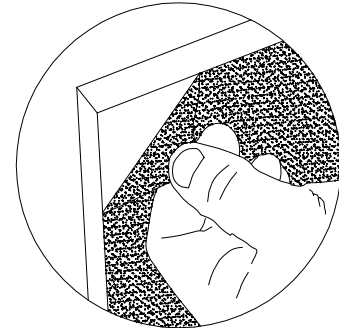
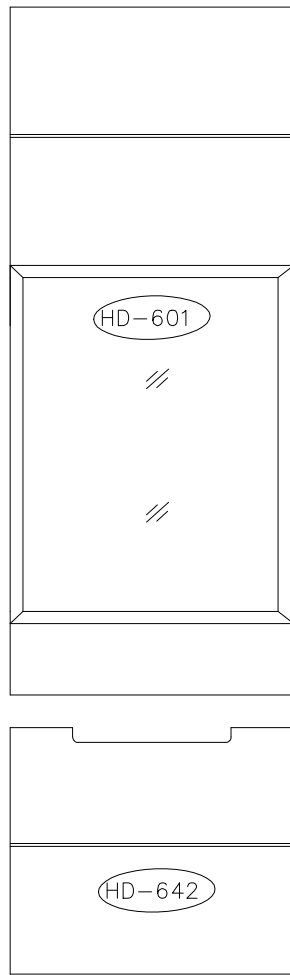

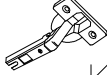
	Uwaga • Upozornini • Achtung • Attention • Caution • Figyelem Attenzione • Opgelet • Внимание • Atentie • Upozornenie • Dikkat	
PL	Mocowanie do ściany jest jednocześnie zabezpieczeniem przed przewróceniem - koniecznie zamontować! Do niektórych rodzajów ścian koniecznie zastosować specjalne kołki mocujące.	
CZ	Montáž na stěnu slouží jako ochrana proti převrhnutí - bezpodmínečně umístěte! U některých typů stěn může být zapotřebí speciální hmoždinka!	
D	Wandbefestigung dient als Klippschutz - unbedingt anbringen! Bei einigen Wandtypen kann ein Spezialdübel erforderlich sein!	
GB	The wall fastening serves to prevent tipping - be absolutely sure to mount it! For certain wall types, a special wall plug may be necessary!	
FR	La fixation murale sert de protection contre le basculement - à installer impérativement ! Pour certains types de murs il faut des chevilles spéciales !	
NL	Bevestiging aan de muur dient als kantelbescherming - zeker en vast bevestigen! Bij enkele muurtypen is een speciale plug misschien vereist!	
IT	Il fissaggio alla parete serve da protezione anti-ribaltamento - attaccarla assolutamente! Per alcune strutture di parete può essere necessario un tassello speciale!	
HU	A termékét a falhoz kell rögzíteni, különben az felborulhat! Egyes fal típusoknál speciális tiplét kell használni!	
RU	Обязательно установите крепление на стене во избежание опрокидывания! Для некоторых типов стен может потребоваться специальный дюбель!	
RO	Sistemul de fixare la perete servește ca protecție la răsturnare - de montat obligatoriu! Pentru unele tipuri de pereți este posibil să fie necesar un diblu special!	
SK	Upevnenie na stenu slúži ako ochrana proti prevráteniu - bezpodmienečne použite! Pre niektoré druhy stien môže byť potrebná špeciálna hmoždinka!	
TR	Duvardaki sabitleme, devrilmeye karşı bir emniyet tedbiridir ve mutlaka monte edilmelidir! Bazı duvar tiplerinde bunun için özel bir dübel gereklidir!	



KR-0	4.0x13	3.0x13
		
K	N	T
4	8	6

3.0x13

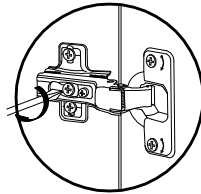
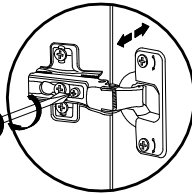
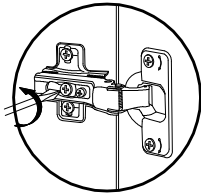
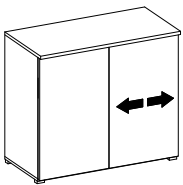
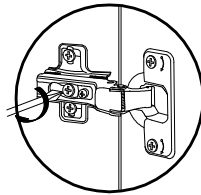
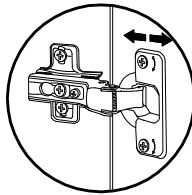
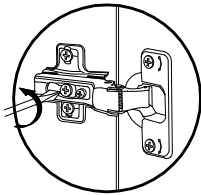
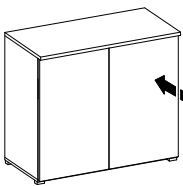
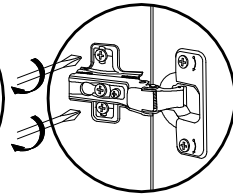
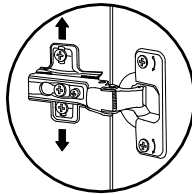
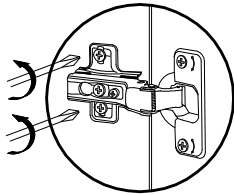
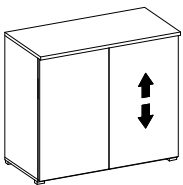
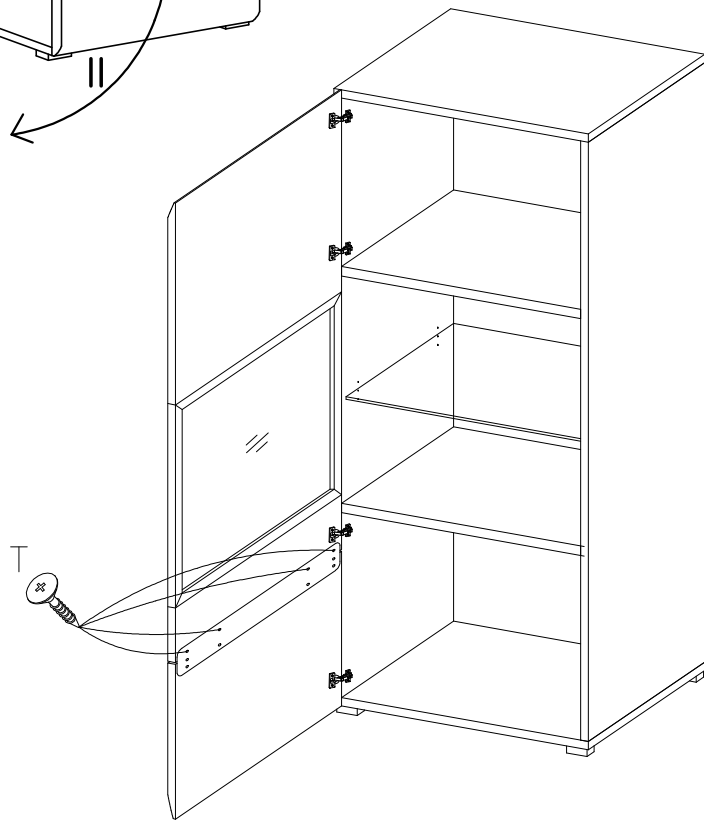
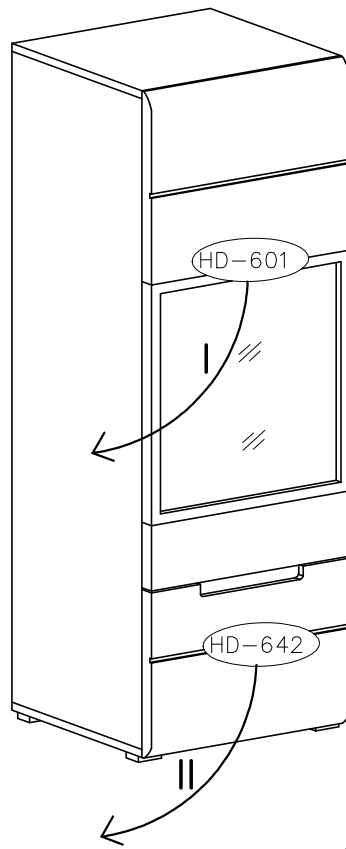
 T
 4

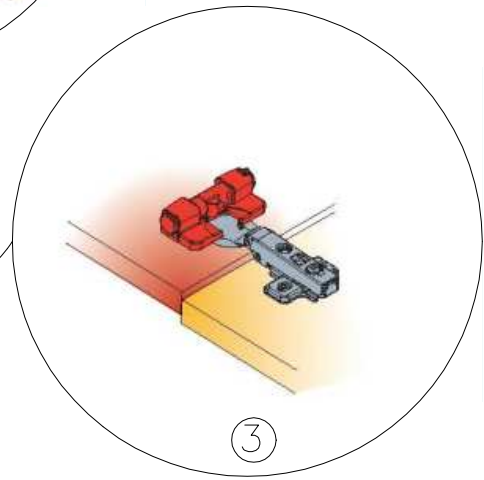
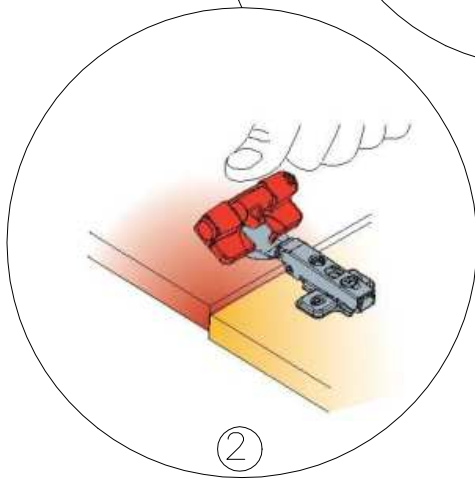
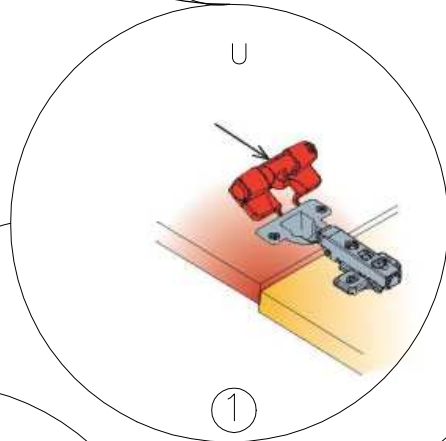
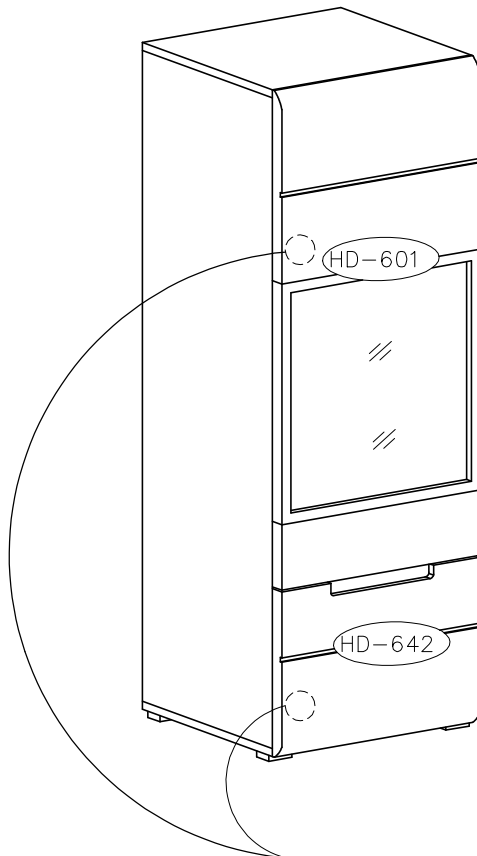
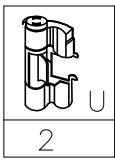

- F** Mettre la porte (égaler les gonds)
- I** Regolare la porta (livellare le parentesi)
- D** Turen einstellen (Scharniere justieren)
- GB** Adjusting the doors (adjusting the hinges)
- NL** Deuren instellen (scharnieren afstellen)
- PL** Nastawic drzwi (wyrownac zawiasy)
- TR** Kapilarin ayarlanmasi (menteselerin seviye ayari)
- RU** Регулировка дверей (регулировка шарнира)
- RO** Ajustati ușa (aliniați balamalele)
- CZ** Seřid'te dveře (vyrovnejte závěsy)
- SK** Zrad'te dvere (vyrovnajzte závesy)
- HU** Állítsa be az ajtót (igazítsa be a zsanérokot)

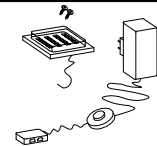



1 KPL

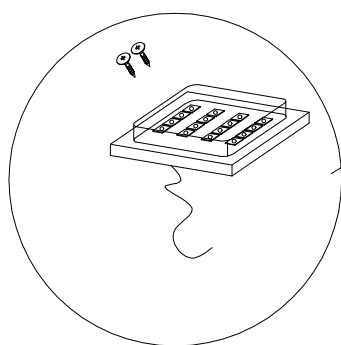
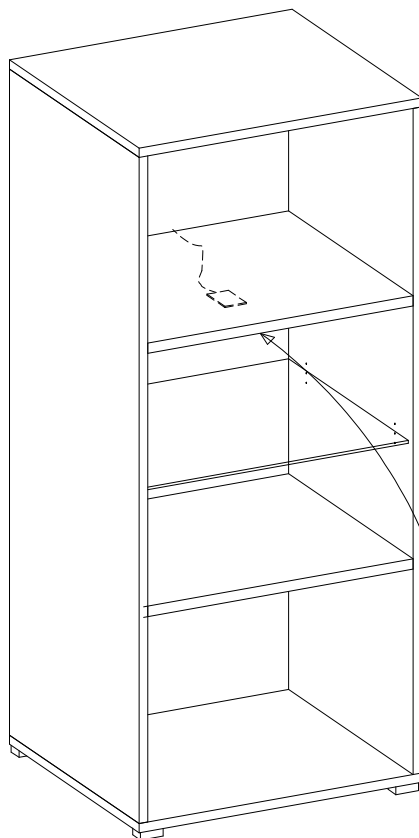

- (PL) **Uwaga: Punkty mocowania opcjonalnego oświetlenia**
- (CZ) **Upozornění: body k připevnění doplňkového osvětlení**
- (D) **Hinweis: Befestigungspunkte für optionale Beleuchtung**
- (GB) **N.B.: Fixing points for optional lighting**
- (F) **Remarque: Points de fixation de l'éclairage optionnel**
- (HU) **Figyelem: Opcionális világítás rögzítési pontjai**
- (I) **NOTA: punti di fissaggio opzionale dell'illuminazione**
- (NL) **OPGELET: Optionele bevestigingspunten van de verlichting.**
- (RU) **ВНИМАНИЕ: Точки крепления дополнительного освещения**
- (RO) **Atenție: Punctele opționale de fixare a iluminatului**
- (SK) **Upozornenie: body k pripevnení dodatočného osvetlení**
- (TR) **Dikkat: Seçenekli aydınlatmanın yerleştirilmesinin noktaları**