

71541

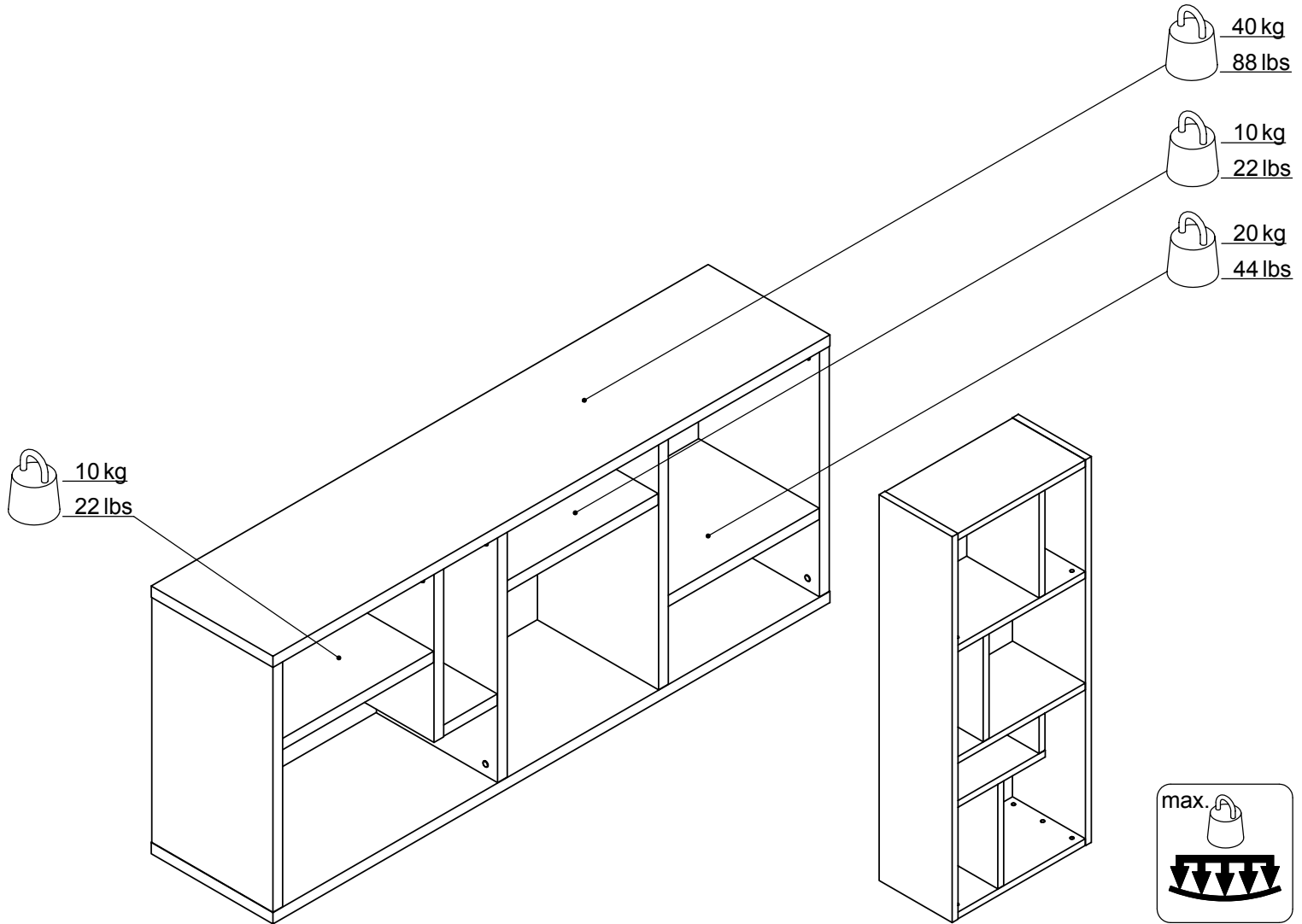

TVILUM-SCANBIRK

Made in Denmark

© TVILUM-SCANBIRK, 25-05-2009

Egon Kristiansens Allé 2
DK-8882 Faarvang, Denmark

HELPLINE



Danmark	Kære kunde, tillykke med Deres produkt. Vi håber, de får glæde af det. Skulle De have spørgsmål eller brug for yderligere information, er De velkommen til at kontakte os på vores Helpline gratis nummer: 80 20 02 80, sende en mail på helpline-scan@tvilum.com , eller se på vores hjemmeside: www.tvilum-scanbirk.com	Norge	Kjære kunde, tillykke med ditt nye produkt. Vi håper De får glede av det. Skulle de ha spørsmål eller brukt for ytligere informasjon, er De velkommen til å kontakte oss på vår Helpline gratis nummer 800 58880, send en mail på Helpline-scan@tvilum.com eller se vår hjemmeside: www.tvilum.scanbirk.com
Ireland	Dear customer. We hope you will enjoy your new product. If you have any questions or need further information, please do not hesitate to contact us on our free Helpline number 1800 554521, or send an e-mail to: helpline-gb@tvilum.com or look at our website: www.tvilum-scanbirk.com	Polska	Drogi kliencie. Mamy nadzieję, że będziesz zadowolony z naszego produktu. Jeżeli masz jakiegokolwiek pytania bądź potrzebujesz informacji prosimy o kontakt z naszą bezpłatną infolinią pod numerem 0-0800 451 15 52 (angielski/niemiecki), wysłanie maila do: helpline-east@tvilum.com lub odwiedzenie naszej strony internetowej www.tvilum-scanbirk.com
United Kingdom	Dear customer. We hope you will enjoy your new product. If you have any questions or need further information, please do not hesitate to contact us on our free Helpline number 0808 101 2230, or send an e-mail to: helpline-gb@tvilum.com or look at our website: www.tvilum-scanbirk.com	Portugal	Prezado cliente, esperamos que aprecie o seu novo produto. Caso tenha alguma questão ou necessite de mais informação ções, por favor contacte-nos através do número grátis da nossa Linha de Apoio 800 845277, envie-nos um e-mail (em Espanhol ou Inglês) para helpline-es@tvilum.com ou consulte o nosso sitio da Internet, em www.tvilum-scanbirk.com
USA	Dear customer. We hope you will enjoy your new product. If you have any questions or need further information, please do not hesitate to contact us on our free Helpline number 1-800-932-2006, or send an e-mail to: helpline-us@tvilum.com or look at our website: www.tvilum-scanbirk.com	Latvija	Cienījamais klient! Mēs ceram, ka jaunais produkts Jūs iepriecinās. Ja Jums rodas jautājumi vai ir nepieciešama turpmāka informācija, lūdzu, nekavējoties sazinieties ar mums, zvanot pa bezmaksas palīdzības tālruni: 800 03214 (angliski/vāciski), nosūtot e-pastu uz adresi: helpline-east@tvilum.com vai arī apmeklējot mūsu tīmekļa vietni: www.tvilum-scanbirk.com
Canada	Dear customer. We hope you will enjoy your new product. If you have any questions or need further information, please do not hesitate to contact us on our free Helpline number 1-800-932-2006, or send an e-mail to: helpline-us@tvilum.com or look at our website: www.tvilum-scanbirk.com	Lietuva	Mielas kliente, tikimės Jums patiks mūsų naujas gaminius. Jeigu kils klausimų ar prireiks papildomos informacijos, nedvejodami rašykite mums el. pašto adresu: helpline-east@tvilum.com (vokiečių/anglų kalba), arba apsilankykite mūsų tinklapyje: www.tvilum-scanbirk.com
Suomi	Hyvä asiakas, onnea uuden hankinnan johdosta. Toivomme, että olette tyytyväisiä. Mikäli tarvitsette lisäinformaatiota, ottakaa yhteyttä Helpline ilmaiseen numeroomme 0800 772410 (englanti), läheta sähköpostia osoitteeseen helpline-scan@tvilum.com tai kotisivumme kautta www.tvilum-scanbirk.com	Россия	Уважаемый клиент! Надеемся, что Вам понравится новый продукт. Если возникнут вопросы или потребуются дополнительная информация, Вы можете связаться с нами по бесплатному телефону горячей линии 8-800-333-73-10, (по-английски/по-немецки) отправить письмо на адрес: helpline-east@tvilum.com или зайти на наш сайт: www.tvilum-scanbirk.com
Belgique	Cher client, félicitations avec votre nouveau produit qui nous l'espérons vous donnera satis faction. Pour tout supplément d'information, vous pourrez nous consulter sur le numéro vert 0800 77176 (français), par E Mail sur helpline-benelux@tvilum.com ou sur notre site internet www.tvilum-scanbirk.com	Slovenská republika	Vážený zákazník, veríme, že využijete Váš nový výrobok. Ak máte akékoľvek otázky, alebo potrebujete ďalšie informácie, môžete zaslať e-mail (v angličtine/nemčine) na adresu helpline-east@tvilum.com , alebo si pozrieť našu internetovú stránku: www.tvilum-scanbirk.com
France	Cher client, félicitations avec votre nouveau produit qui nous l'espérons vous donnera satisfaction. Pour tout supplément d'information, vous pourrez nous consulter sur le numéro vert 0800 912126 (français), par E Mail sur helpline-fr@tvilum.com ou sur notre site internet www.tvilum-scanbirk.com	Slovenija	Draga stranka! Upamo, da boste uživali v svojem novem izdelku. Če imate kakršno koli vprašanje ali potrebujete nadaljnje informacije, lahko pošljete e-pošto (v angleškem/nemškem jeziku) na helpline-east@tvilum.com ali pa si oglejte našo spletno stran: www.tvilum-scanbirk.com
Luxembourg	Cher client, félicitations avec votre nouveau produit qui nous l'espérons vous donnera satis faction.Pour tout supplément d'information, vous pourrez nous consulter sur le numéro vert 8002 3059 (français), par E Mail sur helpline-benelux@tvilum.com ou sur notre site internet www.tvilum-scanbirk.com	España	Estimado cliente, felizidades con su nuevo producto. Esperamos que disfrute de su compra. En el caso de alguna duda o la necesidad de información adicional, no dude en contactar con nuestra Helpline gratuita tlf.: 9009 74582, (será atendido en español), enviar un e-mail a helpline-es@tvilum.com , o entrar a nuestra página web: www.tvilum-scanbirk.com
La Suisse	Cher client, félicitations avec votre nouveau produit qui nous l'espérons vous donnera satisfaction. Pour tout supplément d'information, vous pourrez nous consulter sur le numéro vert 0800 563688 (français), par E Mail sur helpline-fr@tvilum.com ou sur notre site internet www.tvilum-scanbirk.com	Sverige	Bästa kund. Grattis med din nya produkt. Vi hoppas du kommer att vara nöjd med det. Ifall du har frågor eller behöver ytterligare information, är du välkommen att kontakta väran Helpline, gratis telefonnummer:020 1301312 (dansk), email helpline-scan@tvilum.com , eller se på väran hemsida: www.tvilum-scanbirk.com
Ελλάδα	Αγαπητέ πελάτη. Ελπίζουμε να απολαύσετε το νέο σας προϊόν. Αν έχετε οποιαδήποτε ερωτήσεις ή χρειάζεστε περαιτέρω πληροφορίες, μη διστάσετε να επικοινωνήσετε μαζί μας στη δωρεάν Γραμμή Βοήθειας 0800 4512 8001 (Αγγλικά), να μας στείλετε e-mail στη διεύθυνση: helpline-fr@tvilum.com ή να επισκεφθείτε τον ιστότοπό μας: www.tvilum-scanbirk.com	Česká republika	Vážený zákazník. Věříme, že budete spokojeni se zakoupeným výrobkem. V případě dotazů nebo dalších informací, nás prosím, kontaktujte na naší zelené lince 800 143324, nebo prostřednictvím e-mailu : helpline-east@tvilum.com (Anglicky/ Německy)nebo na našich internetových stránkách : www.tvilum-scanbirk.com
Nederland	Beste klant, gefeliciteerd met de aanschaf van uw nieuwe product. Wij hopen dat u er tevreden mee bent. Als u vragen heeft of meer informatie wenst, bent u welkom om contact op te nemen met onze Helpline, op gratis nummer: 0800 0230320 (engels), stuur een mail naar helpline-benelux@tvilum.com , of op onze web-site: www.tvilum-scanbirk.com .	Türkiye	Değerli müşterimiz. Yeni ürününüzü beğeneceğinizi ümit ederiz. Her hangi bir sorunuz olduğunda ya da daha fazla bilgi almak istediğinizde, mesajlarınızı (İngilizce veya Almanca) olarak helpline-east@tvilum.com adresimize yazabilir veya www.tvilum-scanbirk.com adresindeki sitemizi ziyaret edebilirsiniz.
Iceland	Dear customer. We hope you will enjoy your new product. If you have any questions or need further information, please do not hesitate to contact us on our free Helpline number 800 8622 (English), or send an e-mail to: helpline-scan@tvilum.com or look at our website: www.tvilum-scanbirk.com	Deutschland	Lieber Kunde, wir beglückwünschen Sie zum Kauf des Produktes. Wir hoffen, dass Sie viel Freude daran haben werden. Sollten Sie Fragen haben oder weitere Informationen benötigen, steht Ihnen unsere „Helpline“ unter der kostenfreien Telefonnummer 0800 182 7126 zur Verfügung. Alternativ erreichen Sie uns per E-Mail: helpline-de@tvilum.com - oder im Internet unter www.tvilum-scanbirk.com .
L'Italia	Gentile cliente, speriamo che il prodotto sia di Vostro gradimento. In caso di richieste o ulteriori informazioni, non esitate a contattarci attraverso il ns. numeri di assistenza gratuita 800 919019 o mail al seguente indirizzo: helpline-it@tvilum.com o sito internet www.tvilum-scanbirk.com	Magyarország	Tisztelt Ügyfelünk! Reméljük, hogy örömet leli az új termékében. Ha bármilyen kérdése van, illetve ha további információkra van szüksége, nyugodtan vegye fel velünk a kapcsolatot az ingyenesen hívható 06 800 16685 (angol vagy német nyelven), vagy küldjön e-mail-t a helpline-east@tvilum.com címre, vagy látogasson el a web-oldalunkra: www.tvilum-scanbirk.com .
Hrvatska	Dragi kupci, Nadamo se da ćete uživati u vašem novom proizvodu. Ako imate bilo kakvih pitanja ili su Vam potrebne do datne informacije, pošaljite nam e-mail (na engleskom ili njemačkom jeziku) na: helpline-east@tvilum.com ili posjetite našu web stranicu: www.tvilum-scanbirk.com	Österreich	Lieber Kunde, wir beglückwünschen Sie zum Kauf des Produktes. Wir hoffen, dass Sie viel Freude daran haben werden. Sollten Sie Fragen haben oder weitere Informationen benötigen, steht Ihnen unsere „Helpline“ unter der kostenfreien Telefonnummer 0800 295328 (deutsch) zur Verfügung. Alternativ erreichen Sie uns per E-Mail: helpline-de@tvilum.com - oder im Internet unter www.tvilum-scanbirk.com .
Other Countries	Dear customer. We hope you will enjoy your new product. If you have any questions or need further information, you can send an e-mail to: helpline@tvilum.com or look at our website: www.tvilum-scanbirk.com		

10850

x51

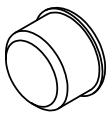

20217

x34

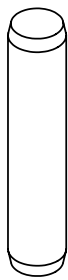

22604

x3

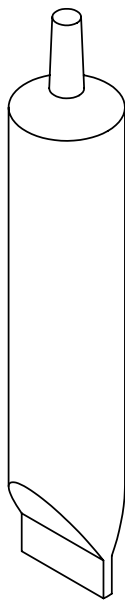

31513

x51

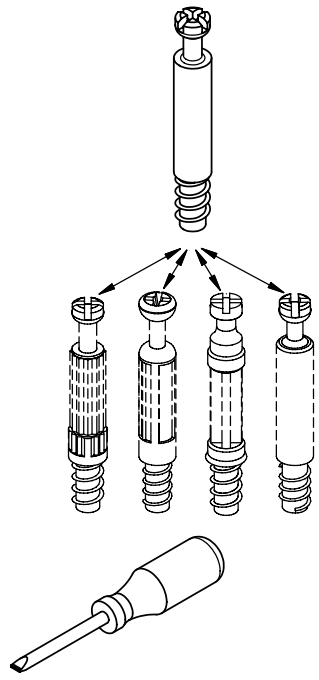

31643

x51



94005

x1

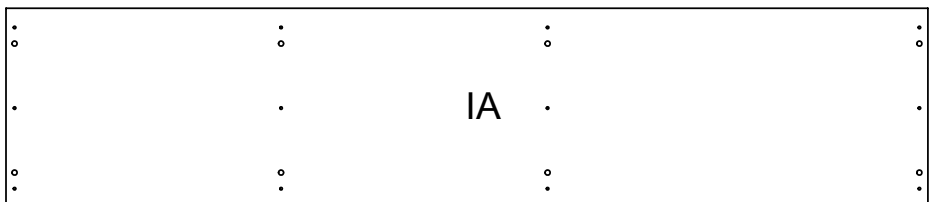
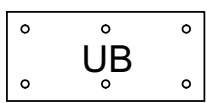
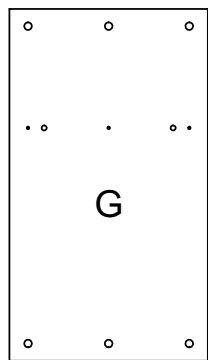
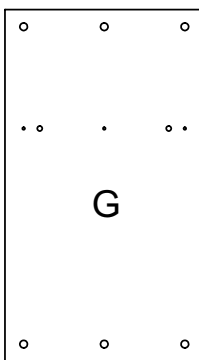
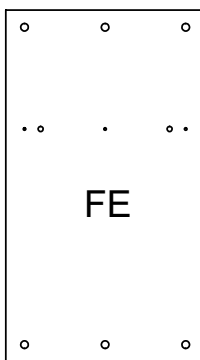
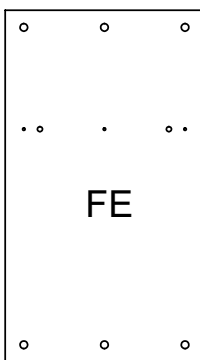
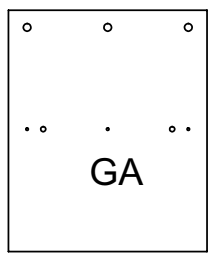
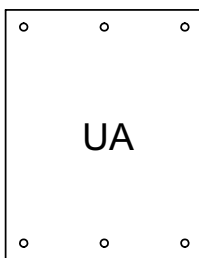
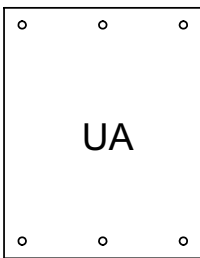
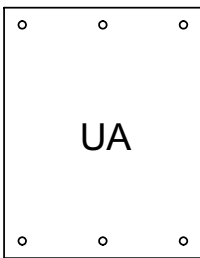
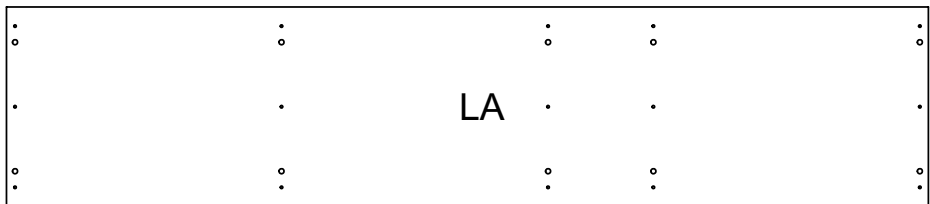
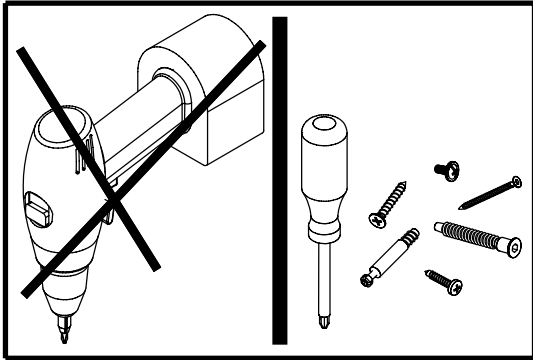
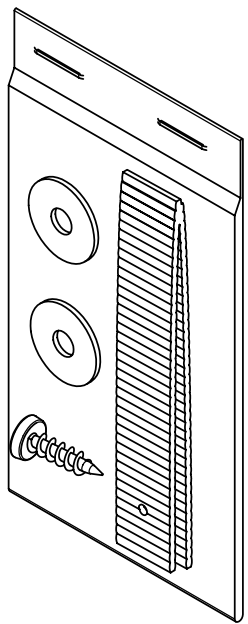

1

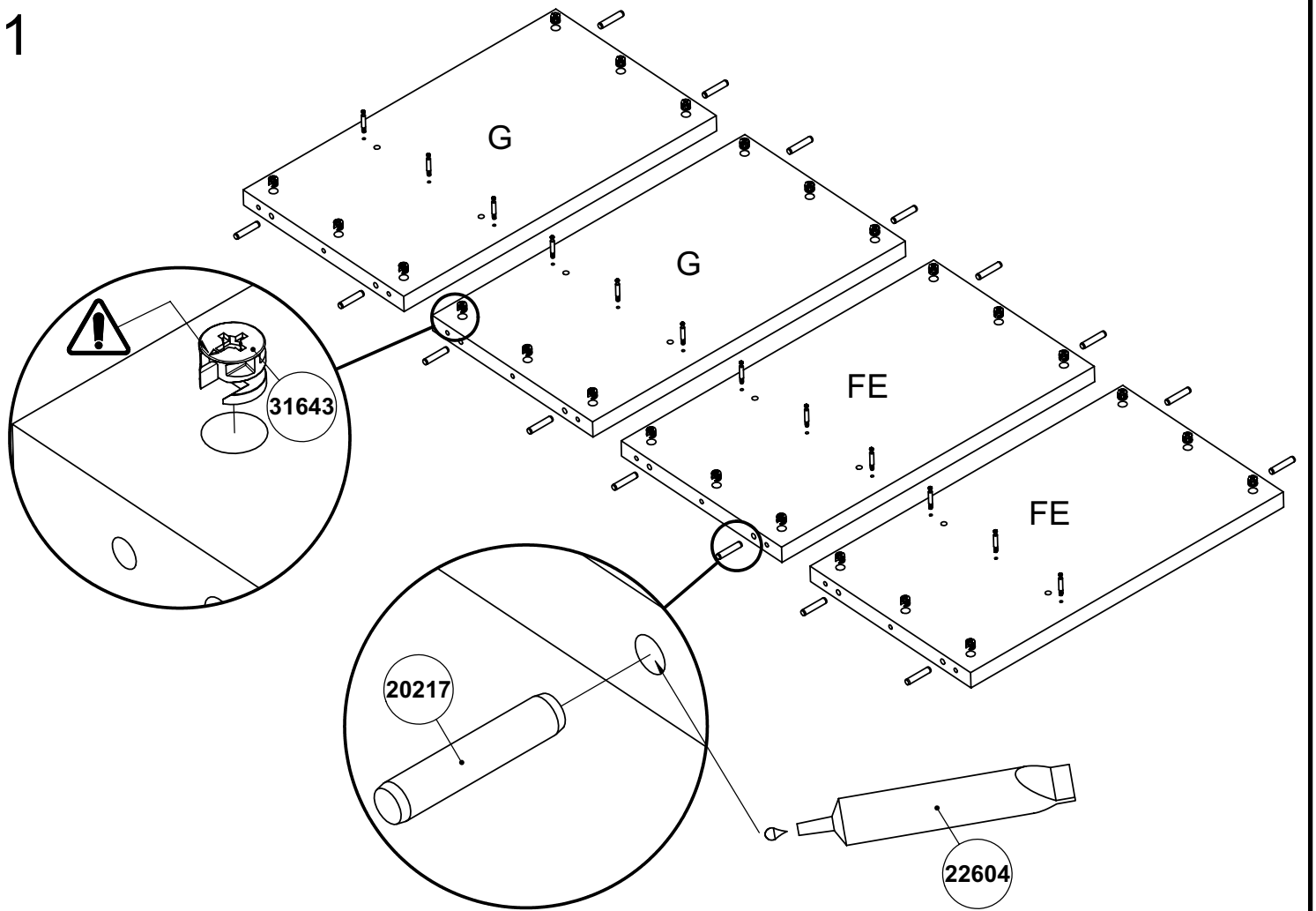

2

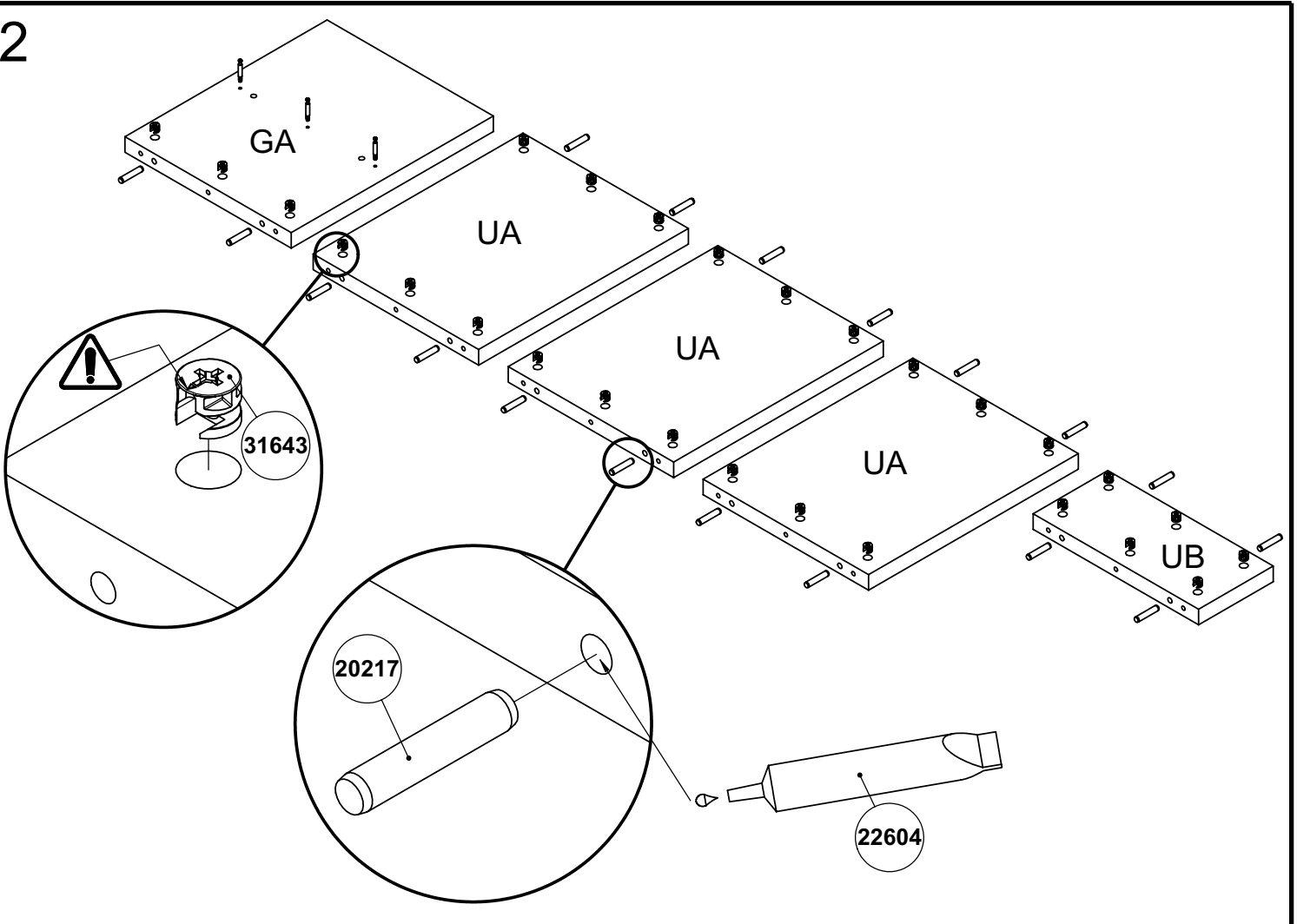

3

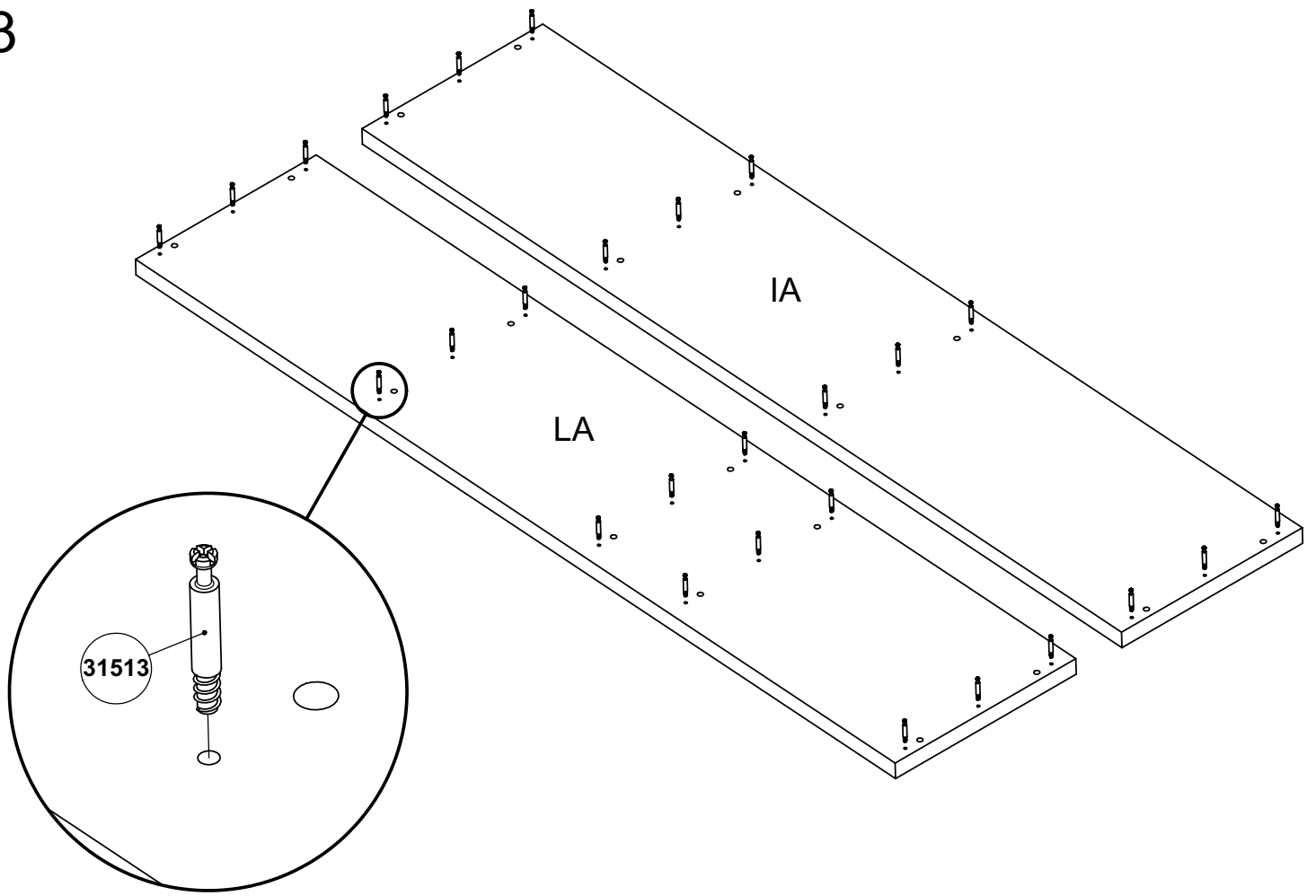

4

