

90min

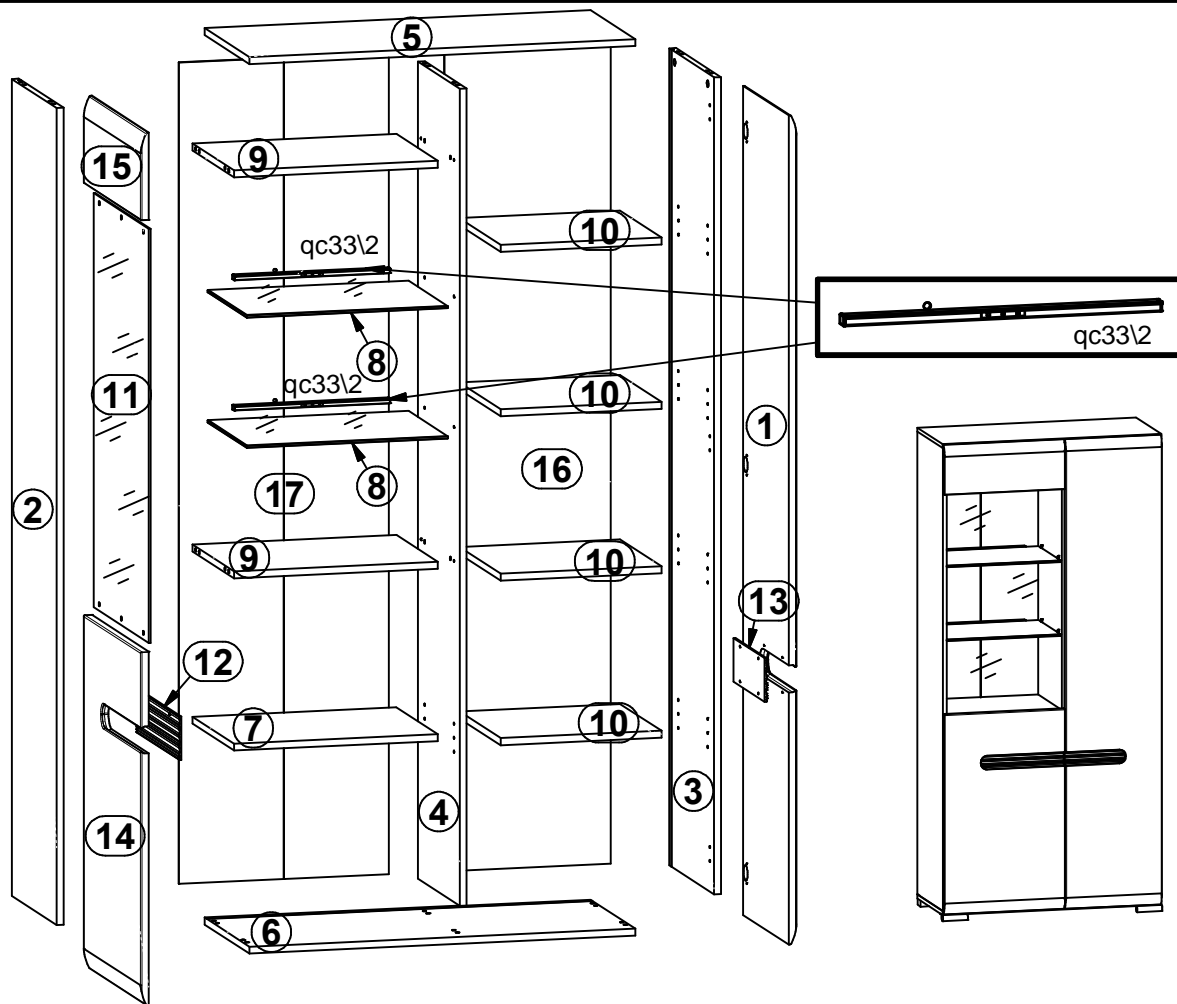

A	B	C (mm)		D
1	S205-028	1896	396	3/3
2	S205-137	1868	390	2/3
3	S205-138	1868	390	2/3
4	S205-139	1868	364	2/3
5	S205-221	900	390	1/3
6	S205-222	900	390	1/3
7	S205-306	475	360	1/3
8	S205-308	469	340	1/3
9	S205-314	475,5	360	1/3
10	S205-315	375	360	1/3
11	S205-553	947	480	3/3
12	S205-583	370	100	3/3
13	S205-586	270	100	3/3
14	S205-716	809	496	3/3
15	S205-718	200	496	3/3
16	S205-915	1878	388	2/3
17	S205-9906	1878	489	2/3
18	qc33\2			1/3

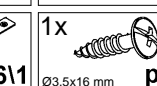

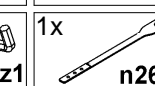
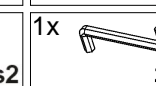
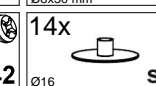
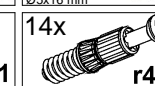
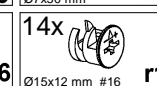
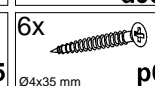
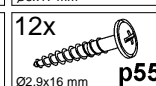
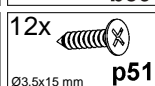
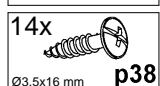
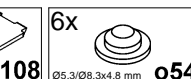
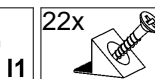
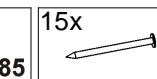
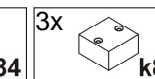
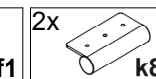
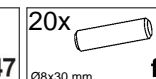
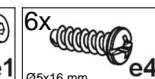
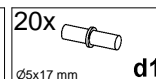
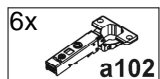
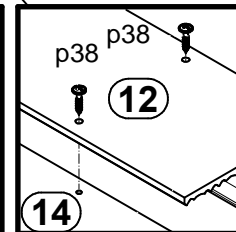
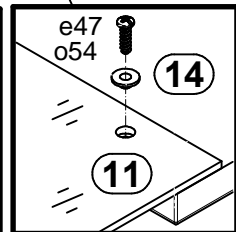
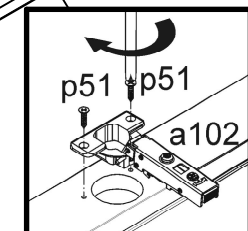
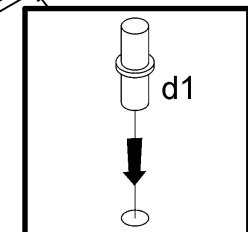
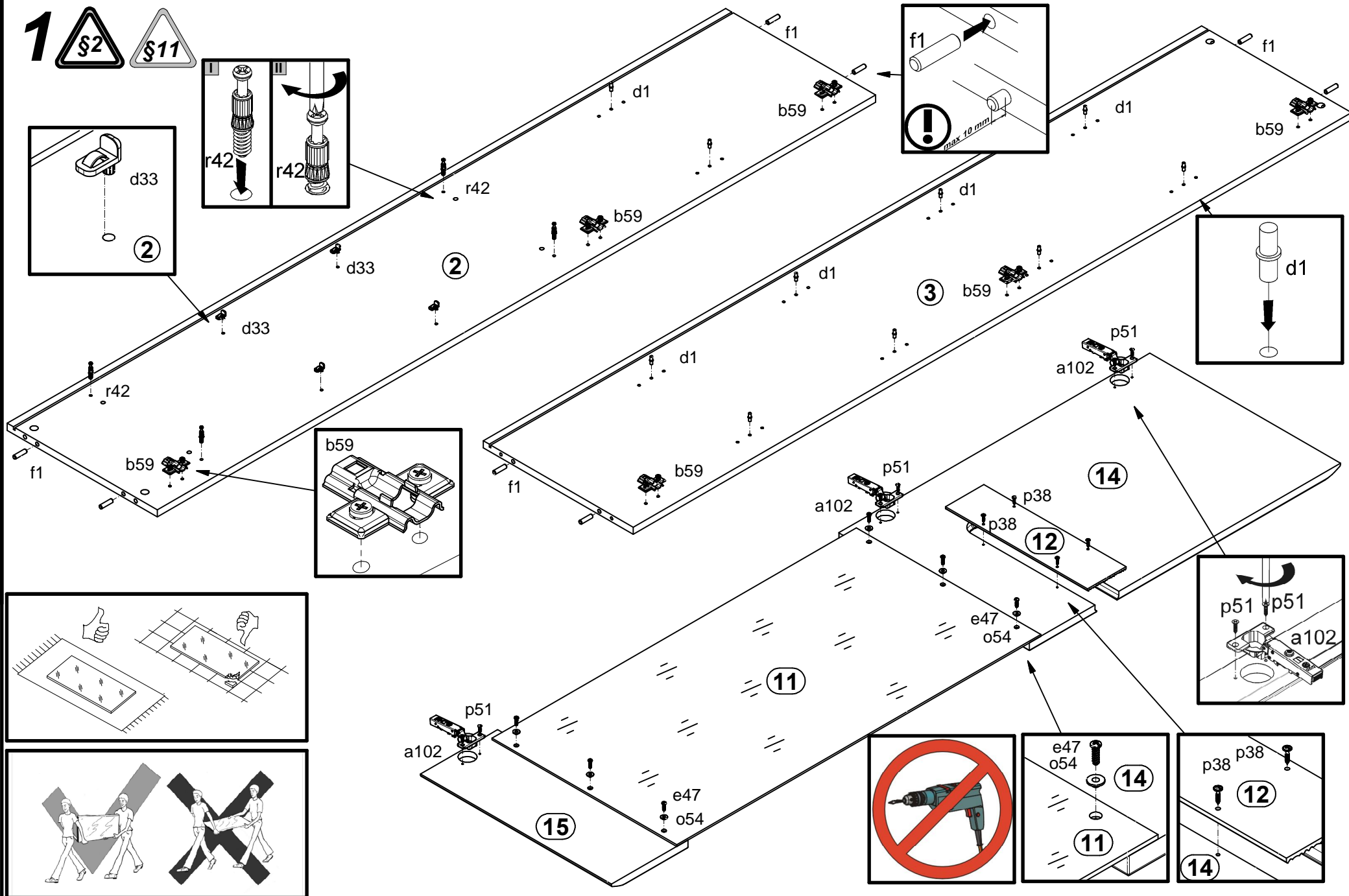
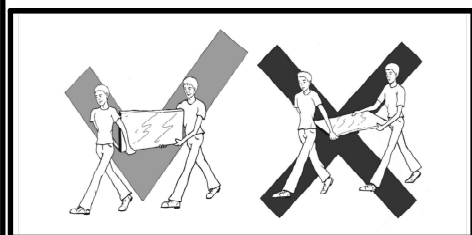
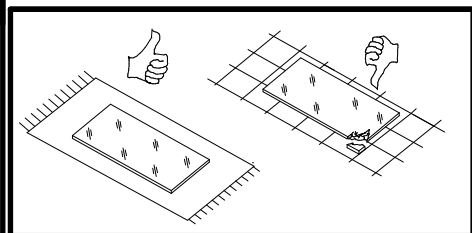
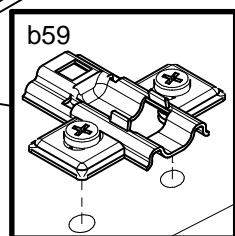
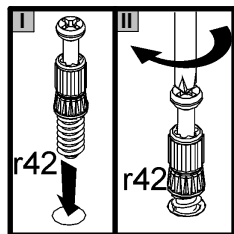
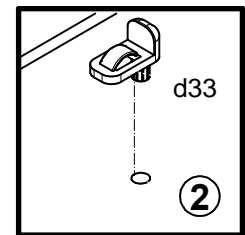

2

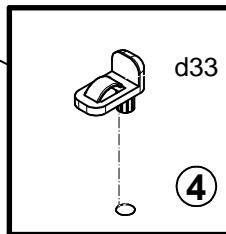
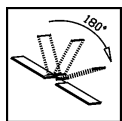
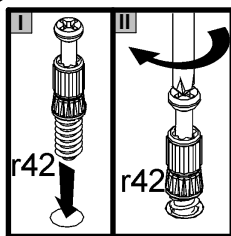
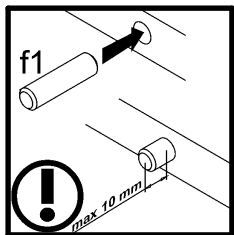
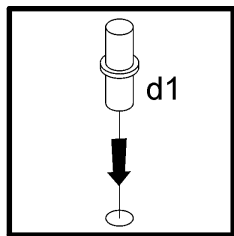
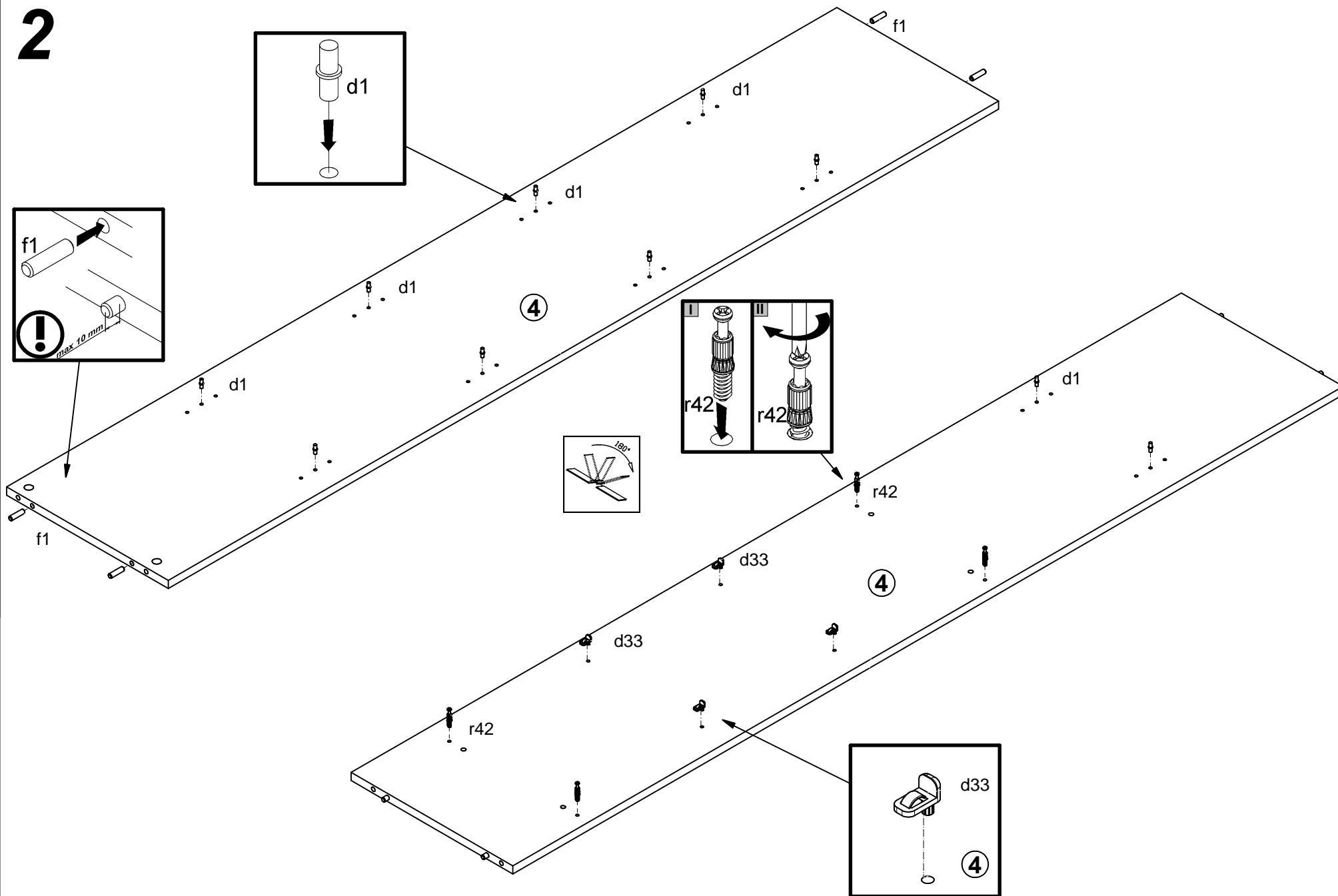

3

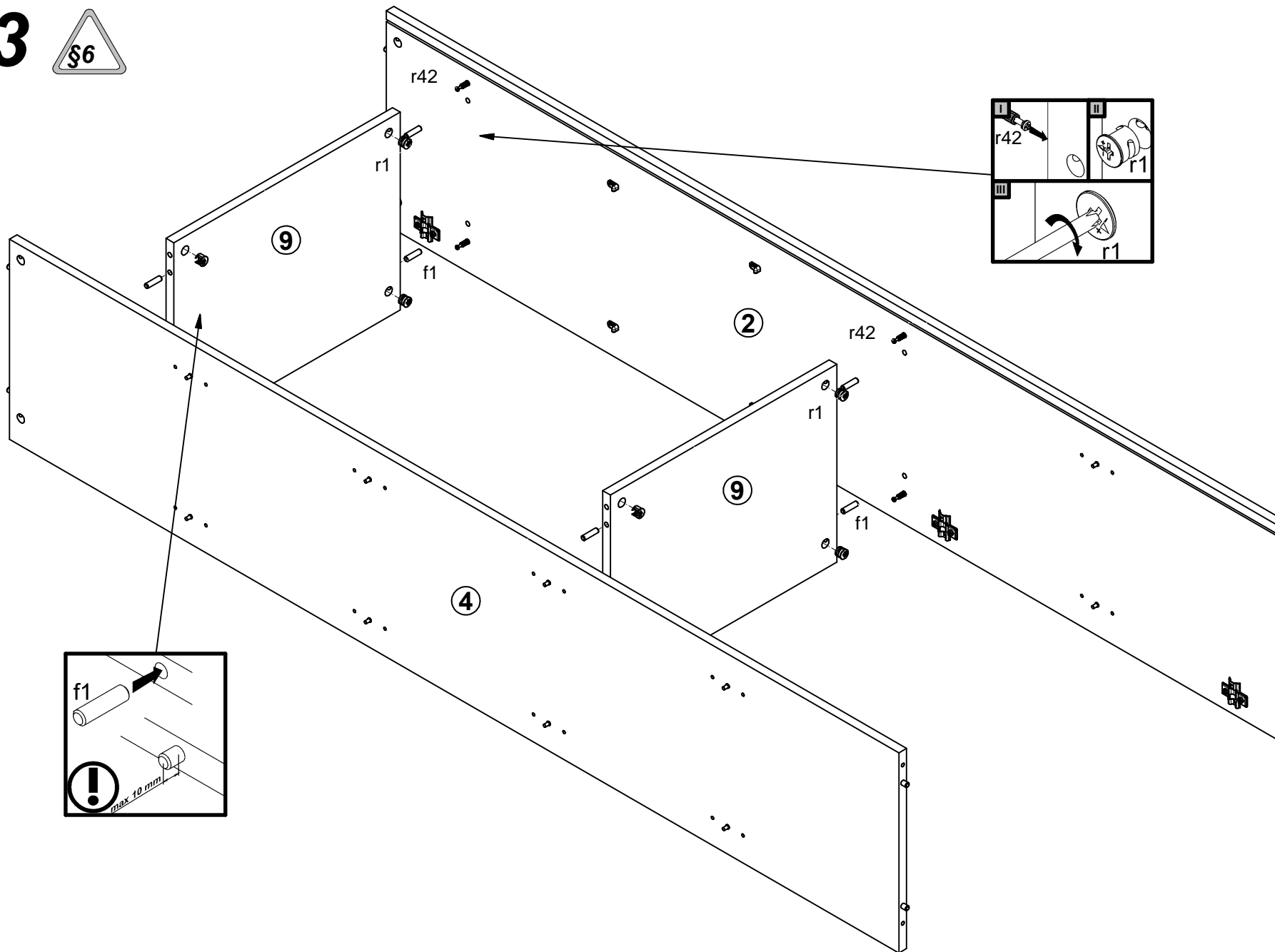

4

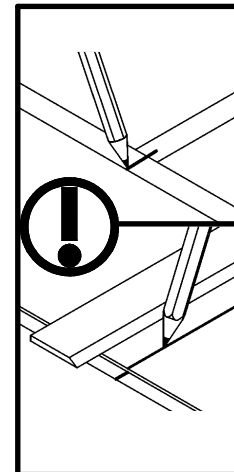
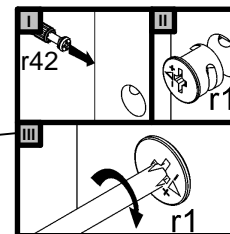
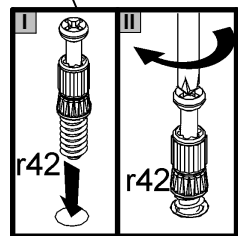
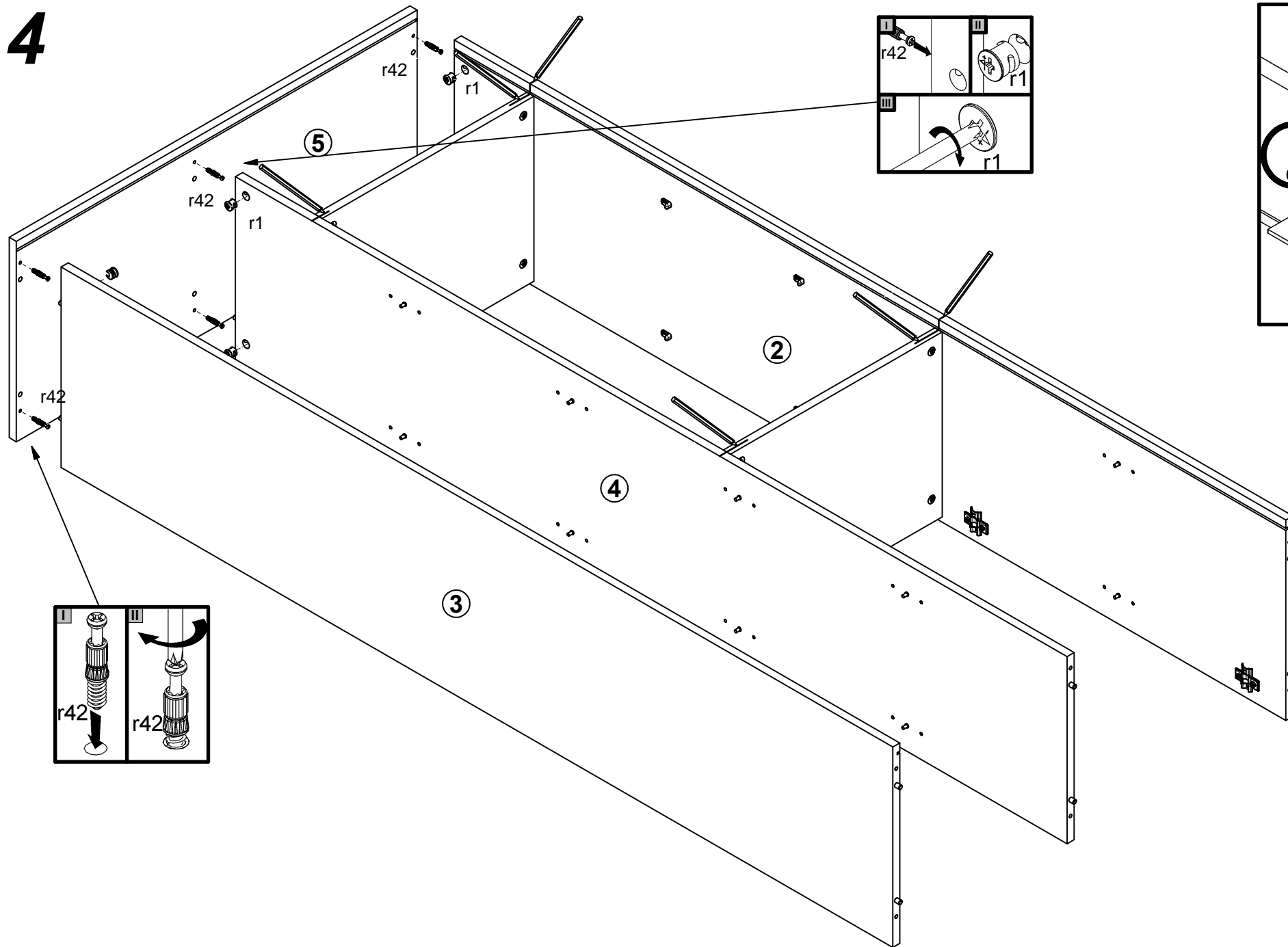

5

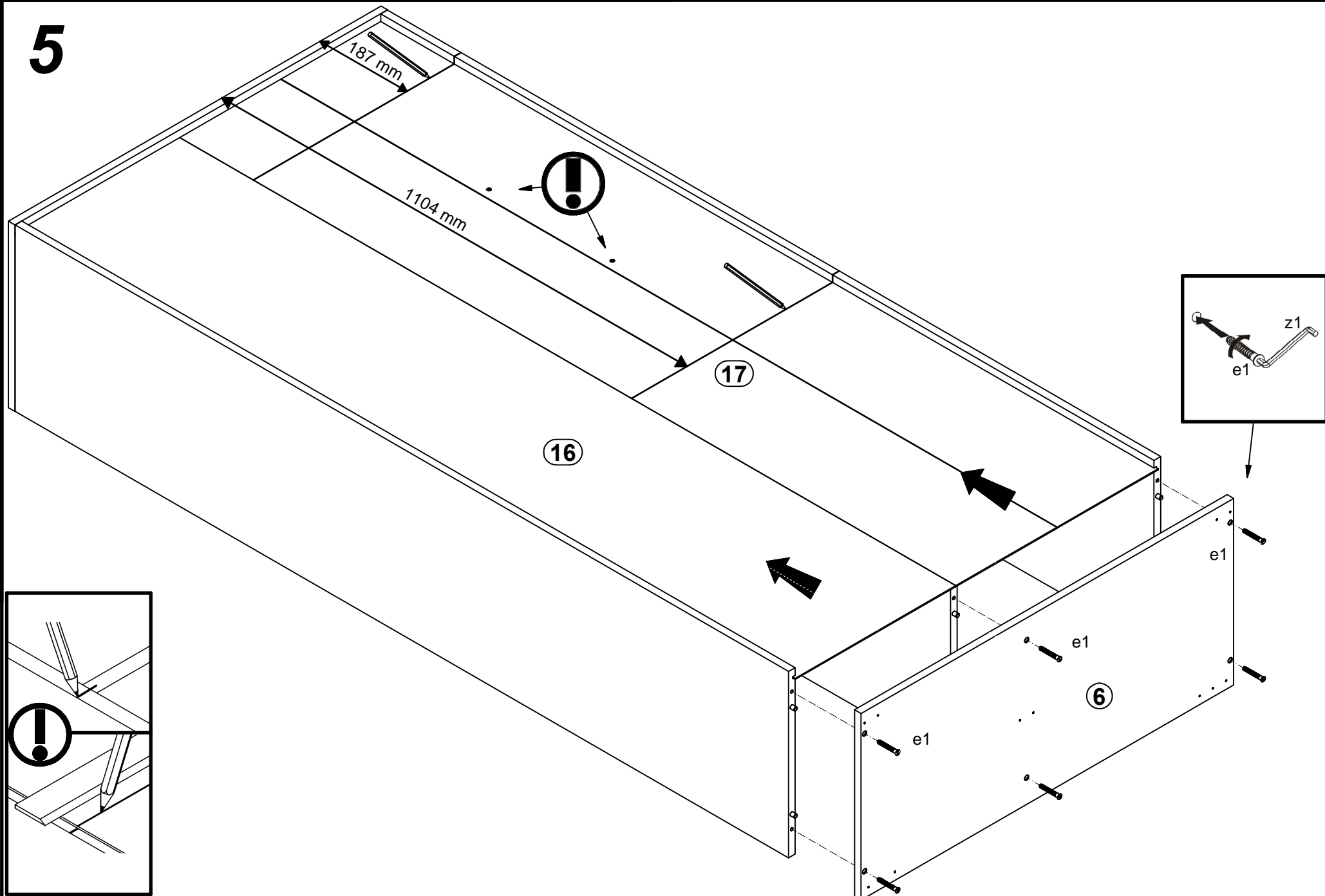

6

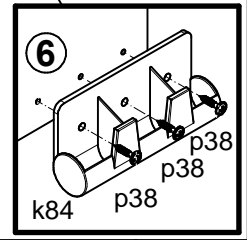
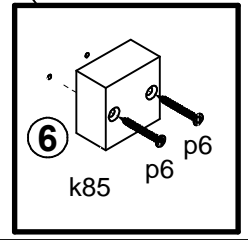
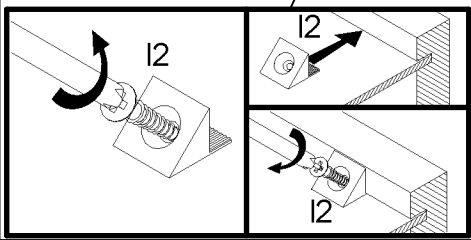
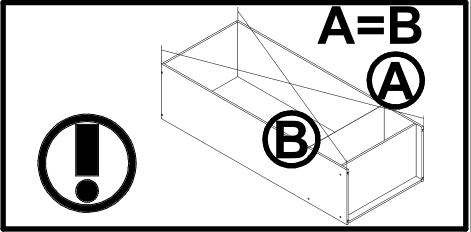
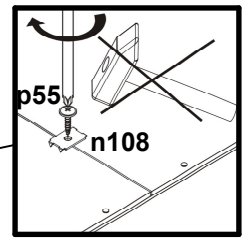
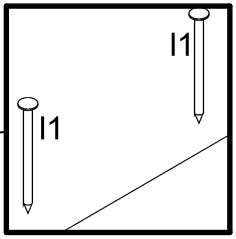
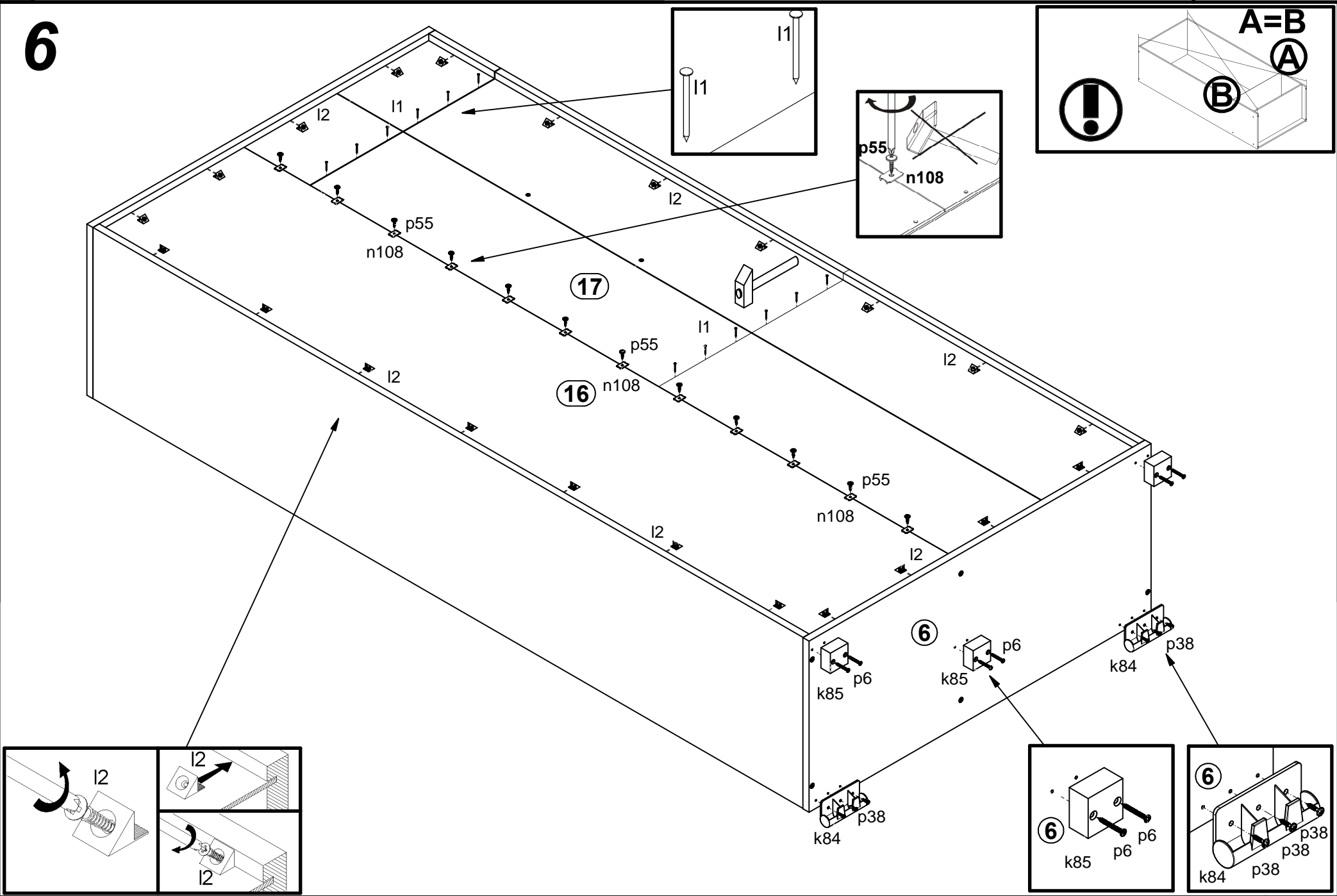

7

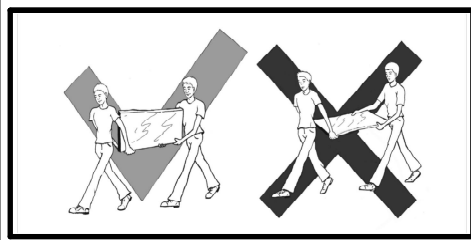
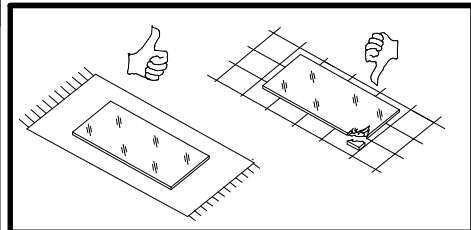
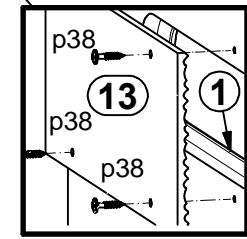
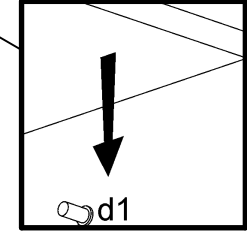
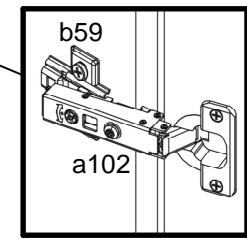
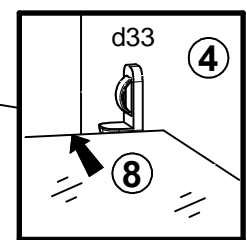
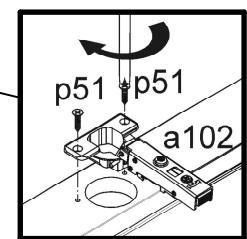
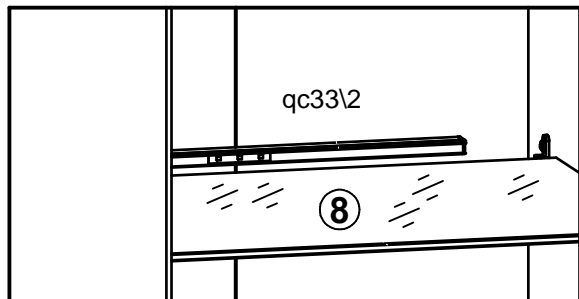
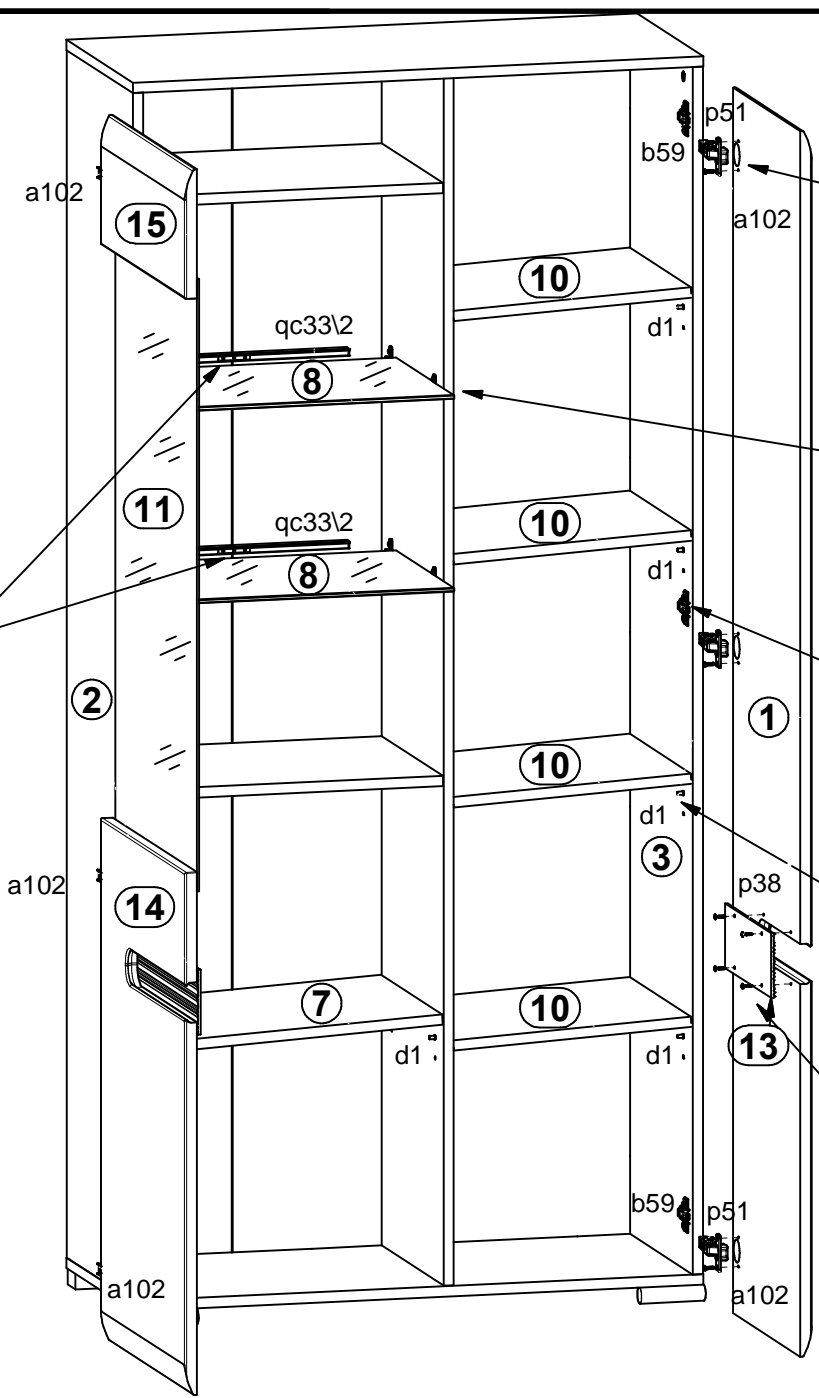

8

